

Documentation for the GNU Go Project
Edition 3.8
February, 2009

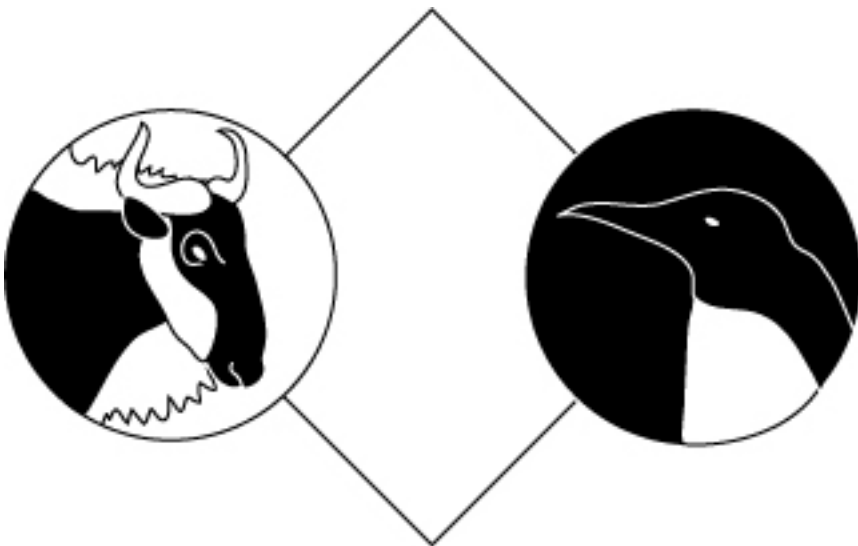

By Arend Bayer, Daniel Bump, Evan Berggren Daniel,
David Denholm, Jerome Dumonteil, Gunnar Farnebäck,
Paul Pogonyshev, Thomas Traber, Tanguy Urvoy, Inge Wallin

GNU Go 3.8

Copyright © 1999, 2000, 2001, 2002, 2003, 2004, 2005, 2006, 2007, 2008 and 2009 [Free Software Foundation](#), Inc.

This is Edition 3.8 of *The GNU Go Project documentation*,
for the 3.8 version of the GNU Go program.

Published by the Free Software Foundation Inc
51 Franklin Street, Fifth Floor
Boston, MA 02110-1301
USA
Tel: 617-542-5942

Permission is granted to make and distribute verbatim or modified copies of this manual is given provided that the terms of the GNU Free Documentation License (see [Section A.5 \[GFDL\]](#), [page 218](#), version 1.3 or any later version) are respected.

Permission is granted to make and distribute verbatim or modified copies of the program GNU Go is given provided the terms of the GNU General Public License (see [Section A.1 \[GPL\]](#), [page 207](#), version 3 or any later version) are respected.

Table of Contents

.....	1
1 Introduction	2
1.1 About GNU Go and this Manual.....	2
1.2 Copyrights.....	2
1.3 Authors.....	3
1.4 Thanks.....	3
1.5 Development.....	3
2 Installation	5
2.1 GNU/Linux and Unix.....	5
2.2 Configure Options.....	5
2.2.1 Ram Cache.....	6
2.2.2 Default Level.....	6
2.2.3 Other Options.....	6
2.3 Compiling GNU Go on Microsoft platforms.....	7
2.3.1 Building with older visual studio.....	7
2.3.2 Building with Visual Studio project files.....	8
2.3.3 Building with Nmake makefiles.....	8
2.3.4 Building with MinGW Makefiles.....	9
2.3.5 Building with MSYS makefiles (MinGW).....	9
2.3.6 Building on cygwin.....	10
2.3.7 Testing on Windows:.....	10
2.4 Macintosh.....	10
3 Using GNU Go	11
3.1 Getting Documentation.....	11
3.2 Running GNU Go via CGoban.....	11
3.3 Other Clients.....	12
3.4 Ascii Interface.....	13
3.5 GNU Go mode in Emacs.....	13
3.6 The Go Modem Protocol and Go Text Protocol.....	13
3.7 Computer Go Tournaments.....	14
3.8 Smart Game Format.....	14
3.9 Invoking GNU Go: Command line options.....	14
3.9.1 Some basic options.....	14
3.9.2 Monte Carlo Options.....	15
3.9.3 Other general options.....	16
3.9.4 Other options affecting strength and speed.....	17
3.9.5 Ascii mode options.....	19
3.9.6 Development options.....	19
3.9.7 Experimental options.....	23

4	GNU Go engine overview	24
4.1	Gathering Information	24
4.2	Move Generators	25
4.3	Move Valuation	26
4.4	Detailed Sequence of Events	27
4.5	Roadmap	29
4.5.1	Files in 'engine/'	29
4.5.2	Files in 'patterns/'	32
4.6	Coding styles and conventions	34
4.6.1	Coding Conventions	34
4.6.2	Tracing	34
4.6.3	Assertions	35
4.6.4	FIXME	35
4.7	Navigating the Source	35
5	Analyzing GNU Go's moves	36
5.1	Interpreting Traces	36
5.2	The Output File	36
5.3	Checking the reading code	36
5.4	Checking the Owl Code	37
5.5	GTP and GDB techniques	38
5.6	Debugging on a Graphical Board	38
5.7	Scoring the game	38
5.8	Colored Display	38
5.8.1	Dragon Display	38
5.8.2	Eye Space Display	39
6	Move generation	40
6.1	Introduction	40
6.2	Generation of move reasons	40
6.3	Detailed Descriptions of various Move Reasons	42
6.3.1	Attacking and defending moves	42
6.3.2	Threats to Attack or Defend	42
6.3.3	Multiple attack or defense moves	42
6.3.4	Cutting and connecting moves	42
6.3.5	Semeai winning moves	43
6.3.6	Making or destroying eyes	43
6.3.7	Antisuji moves	43
6.3.8	Territorial moves	43
6.3.9	Attacking and Defending Dragons	43
6.3.10	Combination Attacks	44
6.4	Valuation of suggested moves	44
6.4.1	Territorial Value	45
6.4.2	Strategical Value	45
6.4.3	Shape Factor	45
6.4.4	Minimum Value	45
6.4.5	Secondary Value	46

6.4.6	Threats and Followup Value	46
6.5	End Game	46
7	Worms and Dragons	47
7.1	Worms	47
7.2	Amalgamation	51
7.3	Connection	52
7.4	Half Eyes and False Eyes	53
7.5	Dragons	54
7.6	Colored Dragon Display	59
8	Eyes and Half Eyes	60
8.1	Local games	60
8.2	Eye spaces	60
8.3	The eyespace as local game	61
8.4	An example	63
8.5	Graphs	64
8.6	Eye shape analysis	65
8.7	Eye Local Game Values	66
8.8	Topology of Half Eyes and False Eyes	67
8.9	Eye Topology with Ko	68
8.10	False Margins	72
8.11	Functions in ‘optics.c’	72
9	The Pattern Code	77
9.1	Overview	77
9.2	Pattern Attributes	78
9.2.1	Constraint Pattern Attributes	78
9.2.2	Action Attributes	79
9.3	Pattern Attributes	80
9.4	Helper Functions	81
9.5	Autohelpers and Constraints	82
9.6	Autohelper Actions	83
9.7	Autohelper Functions	84
9.8	Attack and Defense Database	90
9.9	The Connections Database	90
9.10	Connections Functions	92
9.11	Tuning the Pattern databases	92
9.12	Implementation	95
9.13	Symmetry and transformations	95
9.14	Implementation Details	96
9.15	The “Grid” Optimization	97
9.16	The Joseki Compiler	98
9.17	Ladders in Joseki	99
9.18	Corner Matcher	100
9.19	Emacs Mode for Editing Patterns	102

10	The DFA pattern matcher	103
10.1	Introduction to the DFA	103
10.2	What is a DFA	104
10.3	Pattern matching with DFA	106
10.4	Building the DFA	107
10.5	Incremental Algorithm	109
10.6	Some DFA Optimizations	110
11	Tactical reading	111
11.1	Reading Basics	111
11.1.1	Organization of the reading code	111
11.1.2	Return Codes	111
11.1.3	Reading cutoff and depth parameters	112
11.2	Hashing of Positions	113
11.2.1	Calculation of the hash value	113
11.2.2	Organization of the hash table	114
11.2.3	Hash Structures	115
11.3	Persistent Reading Cache	116
11.4	Ko Handling	117
11.5	A Ko Example	119
11.6	Another Ko Example	120
11.7	Alternate Komaster Schemes	121
11.7.1	Essentially the 2.7.232 scheme	121
11.7.2	Revised 2.7.232 version	121
11.8	Superstrings	122
11.9	Debugging the reading code	122
11.10	Connection Reading	125
12	Pattern Based Reading	126
12.1	The Owl Code	126
12.2	Combination reading	127
13	Influence Function	129
13.1	Conceptual Outline of Influence	129
13.2	Territory, Moyo and Area	129
13.3	Where influence gets used in the engine	130
13.4	Influence and Territory	131
13.5	Details of the Territory Valuation	133
13.6	The Core of the Influence Function	133
13.7	The Influence Algorithm	135
13.8	Permeability	136
13.9	Escape	136
13.10	Break Ins	138
13.11	Surrounded Dragons	140
13.12	Patterns used by the Influence module	141
13.13	Colored display and debugging of influence	143
13.14	Influence Tuning with <code>view.pike</code>	144

14	Monte Carlo Go	146
14.1	Final Remarks	149
15	The Board Library	150
15.1	Board Data structures	150
15.2	The Board Array	151
15.3	Incremental Board data structures	153
15.4	Some Board Functions	156
16	Handling SGF trees in memory	159
16.1	The SGFTree datatype	160
17	Application Programmers Interface to GNU Go	161
17.1	How to use the engine in your own program: getting started	162
17.2	Basic Data Structures in the Engine	162
17.3	The board_state struct	163
17.4	Functions which manipulate a Position	163
17.5	Game handling	165
17.5.1	Functions which manipulate a Gameinfo	166
18	Utility Functions	167
18.1	General Utilities	167
18.2	Print Utilities	172
18.3	Board Utilities	174
18.4	Utilities from 'engine/influence.c'	178
19	The Go Text Protocol	179
19.1	The Go Text Protocol	179
19.2	Running GNU Go in GTP mode	179
19.3	GTP applications	180
19.4	The Metamachine	181
19.4.1	The Standalone Metamachine	182
19.4.2	GNU Go as a Metamachine	182
19.5	Adding new GTP commands	182
19.6	GTP command reference	184
20	Regression testing	202
20.1	Regression testing in GNU Go	202
20.2	Test suites	202
20.3	Running the Regression Tests	203
20.4	Running regress.pike	204
20.5	Viewing tests with Emacs	205
20.6	HTML Regression Views	205
20.6.1	Setting up the HTML regression Views	205

Appendix A Copying	207
A.1 GNU GENERAL PUBLIC LICENSE	207
Preamble	207
TERMS AND CONDITIONS	208
How to Apply These Terms to your New Programs	217
A.5 GNU FREE DOCUMENTATION LICENSE	218
A.6 The Go Text Protocol License	225
Concept Index	226
Functions Index	230

1 Introduction

This is GNU Go 3.8, a Go program. Development versions of GNU Go may be found at <http://www.gnu.org/software/gnugo/devel.html>. Contact us at gnugo@gnu.org if you are interested in helping.

1.1 About GNU Go and this Manual

The challenge of Computer Go is not to **beat** the computer, but to **program** the computer.

In Computer Chess, strong programs are capable of playing at the highest level, even challenging such a player as Garry Kasparov. No Go program exists that plays at the same level as the strongest human players.

To be sure, existing Go programs are strong enough to be interesting as opponents, and the hope exists that some day soon a truly strong program can be written. This is especially true in view of the successes of Monte Carlo methods, and a general recent improvement of computer Go.

Before GNU Go, Go programs have always been distributed as binaries only. The algorithms in these proprietary programs are secret. No-one but the programmer can examine them to admire or criticise. As a consequence, anyone who wished to work on a Go program usually had to start from scratch. This may be one reason that Go programs have not reached a higher level of play.

Unlike most Go programs, GNU Go is Free Software. Its algorithms and source code are open and documented. They are free for any one to inspect or enhance. We hope this freedom will give GNU Go's descendents a certain competitive advantage.

Here is GNU Go's Manual. There are doubtless inaccuracies. The ultimate documentation is in the commented source code itself.

The first three chapters of this manual are for the general user. Chapter 3 is the User's Guide. The rest of the book is for programmers, or persons curious about how GNU Go works. Chapter 4 is a general overview of the engine. Chapter 5 introduces various tools for looking into the GNU Go engine and finding out why it makes a certain move, and Chapters 6–7 form a general programmer's reference to the GNU Go API. The remaining chapters are more detailed explorations of different aspects of GNU Go's internals.

1.2 Copyrights

Copyright 1999, 2000, 2001, 2002, 2003, 2004, 2005, 2006, 2007 and 2008 by the Free Software Foundation except as noted below.

All source files are distributed under the GNU General Public License (see [Section A.1 \[GPL\], page 207](#), version 3 or any later version), except `'gmp.c'`, `'gmp.h'`, `'gtp.c'`, and `'gtp.h'`.

The files `'gtp.c'` and `'gtp.h'` are copyright the Free Software Foundation. In the interests of promoting the Go Text Protocol these two files are licensed under a less restrictive license than the GPL and are free for unrestricted use (see [Section A.6 \[GTP License\], page 225](#)).

The two files `'gmp.c'` and `'gmp.h'` were placed in the public domain by William Shubert, their author, and are free for unrestricted use.

Documentation files (including this manual) are distributed under the GNU Free Documentation License (see [Section A.5 \[GFDL\], page 218](#), version 1.3 or any later version).

The files ‘`regression/games/golois/*sgf`’ are copyright Tristan Cazenave and are included with his permission.

The SGF files in ‘`regression/games/handtalk/`’ are copyright Jessie Annala and are used with permission.

The SGF files in ‘`regression/games/mertin13x13/`’ are copyright Stefan Mertin and are used with permission.

The remaining SGF files are either copyright by the FSF or are in the public domain.

1.3 Authors

GNU Go maintainers are Daniel Bump, Gunnar Farneback and Arend Bayer. GNU Go authors (in chronological order of contribution) are Man Li, Wayne Iba, Daniel Bump, David Denholm, Gunnar Farneback, Nils Lohner, Jerome Dumonteil, Tommy Thorn, Nicklas Ekstrand, Inge Wallin, Thomas Traber, Douglas Ridgway, Teun Burgers, Tanguy Urvoy, Thien-Thi Nguyen, Heikki Levanto, Mark Vytlačil, Adriaan van Kessel, Wolfgang Manner, Jens Yllman, Don Dailey, Måns Ullerstam, Arend Bayer, Trevor Morris, Evan Berggren Daniel, Fernando Portela, Paul Pogonyshv, S.P. Lee and Stephane Nicolet, Martin Holters, Grzegorz Leszczynski and Lee Fisher.

1.4 Thanks

We would like to thank Arthur Britto, David Doshay, Tim Hunt, Matthias Krings, Piotr Lakomy, Paul Leonard, Jean-Louis Martineau, Andreas Roever and Pierce Wetter for helpful correspondence.

Thanks to everyone who stepped on a bug (and sent us a report)!

Thanks to Gary Boos, Peter Gucwa, Martijn van der Kooij, Michael Margolis, Trevor Morris, Måns Ullerstam, Don Wagner and Yin Zheng for help with Visual C++.

Thanks to Alan Crossman, Stephan Somogyi, Pierce Wetter and Mathias Wagner for help with Macintosh. And thanks to Marco Scheurer and Shigeru Mabuchi for helping us find various problems.

Thanks to Jessie Annala for the Handtalk games.

Special thanks to Ebba Berggren for creating our logo, based on a design by Tanguy Urvoy and comments by Alan Crossman. The old GNU Go logo was adapted from Jamal Hanah's typing GNU: <http://www.gnu.org/graphics/atypinggnu.html>. Both logos can be found in ‘`doc/newlogo.*`’ and ‘`doc/oldlogo.*`’.

We would like to thank Stuart Cracraft, Richard Stallman and Man Lung Li for their interest in making this program a part of GNU, William Shubert for writing CGoban and gmp.c, Rene Grothmann for Jago and Erik van Riper and his collaborators for NNGS.

1.5 Development

You can help make GNU Go the best Go program.

This is a task-list for anyone who is interested in helping with GNU Go. If you want to work on such a project you should correspond with us until we reach a common vision of how the feature will work!

A note about copyright. The Free Software Foundation has the copyright to GNU Go. For this reason, before any code can be accepted as a part of the official release of GNU Go, the Free Software Foundation will want you to sign a copyright assignment.

Of course you could work on a forked version without signing such a disclaimer. You can also distribute such a forked version of the program so long as you also distribute the source code to your modifications under the GPL (see [Section A.1 \[GPL\], page 207](#)). But if you want your changes to the program to be incorporated into the version we distribute we need you to assign the copyright.

Please contact the GNU Go maintainers, Daniel Bump (bump@sporadic.stanford.edu) and Gunnar Farneböck (gunnar@lysator.liu.se), to get more information and the papers to sign.

Bug reports are very welcome, but if you can, send us bug FIXES as well as bug reports. If you see some bad behavior, figure out what causes it, and what to do about fixing it. And send us a patch! If you find an interesting bug and cannot tell us how to fix it, we would be happy to have you tell us about it anyway. Send us the sgf file (if possible) and attach other relevant information, such as the GNU Go version number. In cases of assertion failures and segmentation faults we probably want to know what operating system and compiler you were using, in order to determine if the problem is platform dependent.

If you want to work on GNU Go you should subscribe to the [GNU Go development list](#). Discussion of bugs and feedback from established developers about new projects or tuning the existing engine can be done on the list.

2 Installation

You can get the most recent version of GNU Go ftp.gnu.org or a mirror (see <http://www.gnu.org/order/ftp.html> for a list). You can read about newer versions and get other information at <http://www.gnu.org/software/gnugo/>.

2.1 GNU/Linux and Unix

Untar the sources, change to the directory `gnugo-3.8`. Now do:

```
./configure [OPTIONS]
make
```

Several configure options will be explained in the next section. You do not need to set these unless you are dissatisfied with GNU Go's performance or wish to vary the experimental options.

As an example,

```
./configure --enable-level=9 --enable-cosmic-gnugo
```

will make a binary in which the default level is 9, and the experimental “cosmic” option is enabled. A list of all configure options can be obtained by running `./configure --help`. Further information about the experimental options can be found in the next section (see [Section 2.2 \[Configure Options\], page 5](#)).

After running `configure` and `make`, you have now made a binary called ‘`interface/gnugo`’. Now (running as root) type

```
make install
```

to install ‘`gnugo`’ in ‘`/usr/local/bin`’.

There are different methods of using GNU Go. You may run it from the command line by just typing:

```
gnugo
```

but it is nicer to run it using CGoban 1 (under X Window System), Quarry, Jago (on any platform with a Java Runtime Environment) or other client programs offering a GUI.

You can get the most recent version of CGoban 1 from <http://sourceforge.net/projects/cgoban1/>. The earlier version 1.12 is available from <http://www.igoweb.org/~wms/comp/cgoban/index.html>. The CGoban version number MUST be 1.9.1 at least or it won't work. CGoban 2 will not work.

See [Section 3.2 \[CGoban\], page 11](#), for instructions on how to run GNU Go from Cgoban, or See [Section 3.3 \[Other Clients\], page 12](#), for Jago or other clients.

Quarry is available at <http://home.gna.org/quarry/>.

2.2 Configure Options

There are three options which you should consider configuring, particularly if you are dissatisfied with GNU Go's performance.

2.2.1 Ram Cache

By default, GNU Go makes a cache of about 8 Megabytes in RAM for its internal use. The cache is used to store intermediate results during its analysis of the position. More precisely the default cache size is 350000 entries, which translates to 8.01 MB on typical 32 bit platforms and 10.68 MB on typical 64 bit platforms.

Increasing the cache size will often give a modest speed improvement. If your system has lots of RAM, consider increasing the cache size. But if the cache is too large, swapping will occur, causing hard drive accesses and degrading performance. If your hard drive seems to be running excessively your cache may be too large. On GNU/Linux systems, you may detect swapping using the program 'top'. Use the 'f' command to toggle SWAP display.

You may override the size of the default cache at compile time by running one of:

```
./configure --enable-cache-size=n
```

to set the cache size to `n` megabytes. For example

```
./configure --enable-cache-size=32
```

creates a cache of size 32 megabytes. If you omit this, your default cache size will be 8-11 MB as discussed above. Setting cache size negative also gives the default size. You must recompile and reinstall GNU Go after reconfiguring it by running `make` and `make install`.

You may override the compile-time defaults by running 'gnugo' with the option '`--cache-size n`', where `n` is the size in megabytes of the cache you want, and '`--level`' where `n` is the level desired. We will discuss setting these parameters next in detail.

2.2.2 Default Level

GNU Go can play at different levels. Up to level 10 is supported. At level 10 GNU Go is much more accurate but takes an average of about 1.6 times longer to play than at level 8.

The level can be set at run time using the '`--level`' option. If you don't set this, the default level will be used. You can set the default level with the configure option '`--enable-level=n`'. For example

```
./configure --enable-level=9
```

sets the default level to 9. If you omit this parameter, the compiler sets the default level to 10. We recommend using level 10 unless you find it too slow. If you decide you want to change the default you may rerun configure and recompile the program.

2.2.3 Other Options

Anything new in the engine is generally tested as an experimental option which can be turned on or off at compile time or run time. Some "experimental" options such as the break-in code are no longer experimental but are enabled by default.

This section can be skipped unless you are interested in the experimental options.

Moreover, some configure options were removed from the stable release. For example it is known that the owl extension code can cause crashes, so the configure option `--enable-experimental-owl-ext` was disabled for 3.8.

The term "default" must be clarified, since there are really two sets of defaults at hand, runtime defaults specified in '`config.h`' and compile time default values for the runtime defaults, contained in '`configure`' (which is created by editing '`configure.in`' then running `autoconf`. For example we find in '`config.h`'

```

/* Center oriented influence. Disabled by default. */
#define COSMIC_GNUGO 0

/* Break-in module. Enabled by default. */
#define USE_BREAK_IN 1

```

This means that the experimental cosmic option, which causes GNU Go to play a center-oriented game (and makes the engine weaker) is disabled by default, but that the break-in module is used. These are defaults which are used when GNU Go is run without command line options. They can be overridden with the run time options:

```
gnugo --cosmic-gnugo --without-break-in
```

Alternatively you can configure GNU Go as follows:

```
./configure --enable-cosmic-gnugo --disable-experimental-break-in
```

then recompile GNU Go. This changes the defaults in ‘config.h’, so that you do not have to pass any command line options to GNU Go at run time to get the experimental owl extension turned on and the experimental break-in code turned off.

If you want to find out what experimental options were compiled into your GNU Go binary you can run `gnugo --options` to find out. Here is a list of experimental options in GNU Go.

- **experimental-break-in.** Experimental break-in code (see [Section 13.10 \[Break Ins\], page 138](#)). You should not need to configure this because the break in code is enabled by default in level 10, and is turned off at level 9. If you don’t want the breakin code just play at level 9.
- **cosmic-gnugo.** An experimental style which plays a center oriented game and has a good winning rate against standard GNU Go, though it makes GNU Go weaker against other opponents.
- **large-scale.** Attempt to make large-scale captures. See: <http://lists.gnu.org/archive/html/gnugo-devel/2003-07/msg00209.html> for the philosophy of this option. This option makes the engine slower.
- **metamachine.** Enables the metamachine, which allows you to run the engine in an experimental mode whereby it forks a new `gnugo` process which acts as an “oracle.” Has no effect unless combined with the ‘`--metamachine`’ run-time option.

Other options are not experimental, and can be changed as configure or runtime options.

- **chinese-rules** Use Chinese (area) counting.
- **resignation-allowed** Allow GNU Go to resign games. This is on by default.

2.3 Compiling GNU Go on Microsoft platforms

2.3.1 Building with older visual studio

The distribution directories contain some .dsp and .dsw files with GNU Go. These have been brought up to date in the sense that they should work if you have the older VC++ with Visual Studio 6 but the distributed .dsp and .dsw files will only be of use with older version of Visual Studio.

In most cases (unless you are building in Cygwin) the preferred way to build GNU Go on Windows platforms is to use CMake. CMake understands about many versions of Visual C/Visual Studio, and will generate project/solution files for the tools installed on your system. So even if you have Visual Studio 6 you may use CMake and dispense with the distributed .dsp and .dsw files.

2.3.2 Building with Visual Studio project files

Before you compile the GNU Go source, you need to run CMake first, to generate the build files you'll give to Visual Studio.

From the cmd.exe command prompt, CD into the GNU Go source directory. To confirm you're in the right place, you should see the file 'CMakeLists.txt' in the top-level directory of the GNU Go code (as well as others in lower subdirectories).

Direct CMake to generate the new Visual Studio build files by typing:

```
cmake CMakeLists.txt
```

Compile the code by invoking the newly-created Solution file:

```
vcbuild GNUGo.sln
```

This will take a few moments, as CMake generates 4 debug/retail targets:

```
debug
release
minsizerel
relwithdebinfo
```

For each of these targets, Visual Studio is generating a version of gnugo.exe:

```
interface\debug\gnugo.exe
interface\release\gnugo.exe
interface\minsizerel\gnugo.exe
interface\relwithdebinfo\gnugo.exe
```

Additionally, there is an 'Install' target available, that will copy the the gnugo.exe into the %ProgramFiles% directory. To do this, type:

```
vcbuild INSTALL.vcproj
```

This should result in copying GNU/Go into:

```
"%ProgramFiles%\GNUGo\bin\gnugo.exe" --options
```

In addition to command line use, CMake also has a GUI version. Users of the Visual Studio GUI might prefer to use that.

2.3.3 Building with Nmake makefiles

GNU Go will also build using NMake makefiles. Optionally, instead of Visual Studio project/solution files, you may direct CMake to generate NMake makefiles. To generate the makefiles:

```
cmake -G "NMake Makefiles" CMakeLists.txt
```

The default rule for the makefile is 'all'. Use the 'help' rule to show a list of available targets.

```
nmake -f Makefile help
```

To compile GNU Go:

```
nmake -f Makefil, all
```

One sysand 2009 tems, GNU GO may fail to build when using NMake makefiles. only fails the first time run, run NMake again with the 'clean all' targets, and it will compile the second and subsequent times.

```
nmake -f Makefile clean all
```

Which will successfully generate a gnugo.exe.

```
interface\gnugo.exe --options
```

2.3.4 Building with MinGW Makefiles

GNU Go can be built on Windows systems using MinGW.

This development environment uses: the GCC compiler (gcc.exe, not cl.exe), the Microsoft C runtime libraries (MSCRT, not GLibC), the GNU Make build tool (mingw32-make.exe, not NMake), all from the Windows shell (cmd.exe, not sh/bash).

For CMake to work, in addition to the base MinGW installation, the C++ compiler (g++.exe) and GNU Make (mingw32-make.exe) need to be installed. This was tested using GCC v3, not the experimental v4. To debug, use GDB, as the GCC-generated symbols won't work with NTSD/Windbg/Visual Studio.

To create the makfiles, run CMake with the MinGW generator option:

```
cmake -G "MinGW Makefiles" CMakeLists.txt
```

To build GNU Go, from a cmd.exe shell, run GNU Make (against the newly-created 'Makefile' and it's default 'all' target):

```
mingw32-make
..\interface\gnugo.exe --options
```

2.3.5 Building with MSYS makefiles (MinGW)

GNU Go can be built on Windows systems using MSYS.

This development environment uses: the GCC compiler (gcc.exe, not cl.exe), the Microsoft C runtime libraries (MSCRT, not GLibC), the GNU Make build tool (make, not NMake), all from the GNU Bash (sh.exe, not cmd.exe).

To create the makfiles, run CMake with the MSYS generator option:

```
cmake -G "MSYS Makefiles" CMakeLists.txt
```

Start MSYS's Bash shell, either clicking on a shortcut on from the command line:

```
cd /d c:\msys\1.0
msys.bat
```

To build GNU Go, from a Bash shell, run GNU Make (against the newly-created 'Makefile' and it's default 'all' target):

```
make
../interface/gnugo.exe --options
```

To debug, use GDB, as the GCC-generated symbols won't work with NTSD/Windbg/Visual Studio.

2.3.6 Building on cygwin

With Cygwin, you should be able to

```
tar zxvf gnugo-3.8.tar.gz
cd gnugo-3.8
env CC='gcc -mno-cygwin' ./configure
make
```

2.3.7 Testing on Windows:

'regression/regress.cmd' is a simplified cmd.exe-centric port of the main gnugo Unix shell script regress.sh. It can be used to help verify that the generated binary might be operational. Read the script's comment header for more information. For access to the full GNU Go tests, use Unix, not Windows.

To test:

```
cd regression
regress.cmd ..\interface\gnugo.exe
```

2.4 Macintosh

If you have Mac OS X you can build GNU Go using Apple's compiler, which is derived from GCC. You will need Xcode.

One issue is that the configure test for socket support is too conservative. On OS/X, the configure test fails, but actually socket support exists. So if you want to be able to connect to the engine through tcp/ip (using gtp) you may `configure --enable-socket-support`. There will be an error message but you may build the engine and socket support should work.

3 Using GNU Go

3.1 Getting Documentation

You can obtain a printed copy of the manual by running `make gnugo.pdf` in the ‘doc/’ directory, then printing the resulting file. The manual contains a great deal of information about the algorithms of GNU Go.

On platforms supporting info documentation, you can usually install the manual by executing ‘make install’ (running as root) from the ‘doc/’ directory. This will create a file called ‘gnugo.info’ (and a few others) and copy them into a system directory such as ‘/usr/local/share/info’. You may then add them to your info directory tree with the command `install-info --info-file=[path to gnugo.info] --info-dir=[path to dir]`. The info documentation can be read conveniently from within Emacs by executing the command `Control-h i`.

Documentation in ‘doc/’ consists of a man page ‘gnugo.6’, the info files ‘gnugo.info’, ‘gnugo.info-1’, ... and the Texinfo files from which the info files are built. The Texinfo documentation contains this User’s Guide and extensive information about the algorithms of GNU Go, for developers.

If you want a typeset copy of the Texinfo documentation, you can make `gnugo.dvi`, `gnugo.ps`, or `gnugo.pdf` in the ‘doc/’ directory. (`make gnugo.pdf` only works after you have converted all .eps-files in the doc/ directory to .pdf files, e.g. with the utility `epstopdf`.)

You can make an HTML version with the command `makeinfo --html gnugo.texi`. If you have `texi2html`, better HTML documentation may be obtained by `make gnugo.html` in the ‘doc/’ directory.

User documentation can be obtained by running `gnugo --help` or `man gnugo` from any terminal, or from the Texinfo documentation.

Documentation for developers is in the Texinfo documentation, and in comments throughout the source. Contact us at gnugo@gnu.org if you are interested in helping to develop this program.

3.2 Running GNU Go via CGoban

There are two different programs called CGoban, both written by William Shubert. In this documentation, CGoban means CGoban 1.x, the older program. You should get a copy with version number 1.12 or higher.

CGoban is an extremely nice way to run GNU Go. CGoban provides a beautiful graphic user interface under X Window System.

Start CGoban. When the CGoban Control panel comes up, select “Go Modem”. You will get the Go Modem Protocol Setup. Choose one (or both) of the players to be “Program,” and fill out the box with the path to ‘gnugo’. After clicking OK, you get the Game Setup window. Choose “Rules Set” to be Japanese (otherwise handicaps won’t work). Set the board size and handicap if you want.

If you want to play with a komi, you should bear in mind that the GMP does not have any provision for communicating the komi. Because of this misfeature, unless you set the

komi at the command line GNU Go will have to guess it. It assumes the komi is 5.5 for even games, 0.5 for handicap games. If this is not what you want, you can specify the komi at the command line with the ‘--komi’ option, in the Go Modem Protocol Setup window. You have to set the komi again in the Game Setup window, which comes up next.

Click OK and you are ready to go.

In the Go Modem Protocol Setup window, when you specify the path to GNU Go, you can give it command line options, such as ‘--quiet’ to suppress most messages. Since the Go Modem Protocol preempts standard I/O other messages are sent to stderr, even if they are not error messages. These will appear in the terminal from which you started CGoban.

3.3 Other Clients

In addition to CGoban (see [Section 3.2 \[CGoban\], page 11](#)) there are a number of other good clients that are capable of running GNU Go. Here are the ones that we are aware of that are Free Software. This list is part of a larger list of free Go programs that is maintained at http://www.gnu.org/software/gnugo/free_go_software.html.

- Quarry (<http://home.gna.org/quarry/>) is a GPL’d client that supports GTP. Works under GNU/Linux and requires GTK+ 2.x and libsvg 2.5. Supports GNU Go as well as other engines. Can play not only Go, but also a few other board games.
- qGo (<http://sourceforge.net/projects/qgo/>) is a full featured Client for playing on the servers, SGF viewing/editing, and GNU Go client written in C++ for GNU/Linux, Windows and Mac OS X. Can play One Color Go. Licensed GPL and QPL.
- ccGo (<http://ccd.w.org/~cjj/prog/ccgo/>) is a GPL’d client written in C++ capable of playing with GNU Go, or on IGS.
- RubyGo (<http://rubygo.rubyforge.org/>) is a GPL’d client by J.-F. Menon for IGS written in the scripting language Ruby. RubyGo is capable of playing with GNU Go using the GTP.
- Dingoui (<http://dingoui.sourceforge.net/>) is a free GMP client written in GTK+ which can run GNU Go.
- Jago (<http://www.rene-grothmann.de/jago/>) is a GPL’d Java client which works for both Microsoft Windows and X Window System.
- Sente Software’s FreeGoban (<http://www.sente.ch/software/goban/freegoban.html>) is a well-liked user interface for GNU Go (and potentially other programs) distributed under the GPL.
- Mac GNU Go (<http://www1.u-netsurf.ne.jp/~future/HTML/macgnugo.html>) is a front end for GNU Go 3.2 with both English and Japanese versions. License is GPL.
- Quickiego (<http://www.geocities.com/secretmojo/QuickieGo/>) is a Mac interface to GNU Go 2.6.
- Gogui (<http://sourceforge.net/projects/gogui/>) from Markus Enzenberger is a Java workbench that allows you to play with a gtp (<http://www.lysator.liu.se/~gunnar/gtp>) engine such as GNU Go. Licence is GPL. Gogui does not support gmp or play on servers but is potentially very useful for programmers working on GNU Go or other engines.

3.4 Ascii Interface

Even if you do not have any client program, you can play with GNU Go using its default Ascii interface. Simply type `gnugo` at the command line, and GNU Go will draw a board. Typing `help` will give a list of options. At the end of the game, pass twice, and GNU Go will prompt you through the counting. You and GNU Go must agree on the dead groups—you can toggle the status of groups to be removed, and when you are done, GNU Go will report the score.

You can save the game at any point using the `save filename` command. You can reload the game from the resulting SGF file with the command `gnugo -l filename --mode ascii`. Reloading games is not supported when playing with CGoban. However you can use CGoban to save a file, then reload it in ascii mode.

You may play games with a time limit against GNU Go in ascii mode. For this, the Canadian time control system is used. (See <http://en.wikipedia.org/wiki/Byoyomi> and <http://senseis.xmp.net/?CanadianByoyomi>.) That is, you have a main time to be followed by byo-yomi periods. After the main time is exhausted you have a certain number of moves to be made in a certain number of seconds. (see [Section 3.9 \[Invoking GNU Go\], page 14](#))

3.5 GNU Go mode in Emacs

You can run GNU Go from Emacs. This has the advantage that you place the stones using the cursor arrow keys or with the mouse, and you can have a nice graphical display of the board within emacs.

You will need the file ‘`interface/gnugo.el`’. There is a version of this distributed with GNU Go but it only works with Emacs 21. Most Emacsen are Emacs 22 however. Therefore you should get the latest version of `gnugo.el` by Thien-Thi Nguyen, which you can find at <http://www.gnuvola.org/software/j/gnugo/> or <http://www.emacswiki.org/emacs/gnugo.el>.

You will also need some xpm files for the graphical display. You can either use those distributed by Thien-Thi Nguyen (at the first URL above) or those distributed with GNU Go, either the file ‘`interface/gnugo-xpms.el`’ or (for high resolution displays) ‘`interface/gnugo-big-xpms.el`’.

Load the file ‘`interface/gnugo.el`’ and ‘`interface/gnugo-xpms.el`’. You may do this using the Emacs `M-x load-file` command.

When you start a game with `M-x gnugo`, you will first see an ascii board. However typing ‘`i`’ toggles a graphical board display which is very nice. This is a pleasant way to play GNU Go. You may get help by typing `C-x m`.

3.6 The Go Modem Protocol and Go Text Protocol

The Go Modem Protocol (GMP) was developed by Bruce Wilcox with input from David Fotland, Anders Kierulf and others, according to the history in <http://www.britgo.org/tech/gmp.html>.

Any Go program *should* support this protocol since it is a standard. Since CGoban supports this protocol, the user interface for any Go program can be done entirely through

CGoban. The programmer can concentrate on the real issues without worrying about drawing stones, resizing the board and other distracting issues.

GNU Go 3.0 introduced a new protocol, the Go Text Protocol (see [Chapter 19 \[GTP\], page 179](#)) which we hope can serve the functions currently used by the GMP. The GTP is becoming increasingly adopted by other programs as a method of interprocess communication, both by computer programs and by clients. Still the GMP is widely used in tournaments.

3.7 Computer Go Tournaments

Computer Tournaments currently use the Go Modem Protocol. The current method followed in such tournaments is to connect the serial ports of the two computers by a “null modem” cable. If you are running GNU/Linux it is convenient to use CGoban. If your program is black, set it up in the Go Modem Protocol Setup window as usual. For White, select “Device” and set the device to `/dev/cua0` if your serial port is COM1 and `/dev/cua1` if the port is COM2.

3.8 Smart Game Format

The Smart Game Format (SGF), is the standard format for storing Go games. GNU Go supports both reading and writing SGF files. The SGF specification (FF[4]) is at: <http://www.red-bean.com/sgf/>

3.9 Invoking GNU Go: Command line options

3.9.1 Some basic options

- `--help`, `-h`
Print a help message describing the options. This will also tell you the defaults of various parameters, most importantly the level and cache size. The default values of these parameters can be set before compiling by `configure`. If you forget the defaults you can find out using `--help`.
- `--boardsize size`
Set the board size
- `--komi num`
Set the komi
- `--level level`
GNU Go can play with different strengths and speeds. Level 10 is the default. Decreasing the level will make GNU Go faster but less accurate in its reading.
- `--quiet`, `--silent`
Don't print copyright and other messages. Messages specifically requested by other command line options, such as `--trace`, are not suppressed.
- `-l`, `--infile filename`
Load the named SGF file. GNU Go will generate a move for the player who is about to move. If you want to override this and generate a move for

the other player you may add the option ‘`--color <color>`’ where *<color>* is black or white.

- ‘`-L`’, ‘`--until move`’
Stop loading just before the indicated move is played. *move* can be either the move number or location.
- ‘`-o`’, ‘`--outfile filename`’
Write sgf output to file
- ‘`-O`’, ‘`--output-flags flags`’
Add useful information to the sgf file. Flags can be ‘d’, ‘v’ or both (i.e. ‘dv’). If ‘d’ is specified, dead and critical dragons are marked in the sgf file. If ‘v’ is specified, move valuations around the board are indicated.
- ‘`--mode mode`’
Force the playing mode (‘ascii’, ‘emacs’, ‘gmp’ or ‘gtp’). The default is ASCII, but if no terminal is detected GMP (Go Modem Protocol) will be assumed. In practice this is usually what you want, so you may never need this option.
- ‘`--resign-allowed`’
GNU Go will resign games if this option is enabled. This is the default unless you build the engine with the configure option ‘`--disable-resignation-allowed`’. Unfortunately the Go Modem Protocol has no provision for passing a resignation, so this option has no effect in GMP mode.
- ‘`--never-resign`’
GNU Go will not resign games.
- ‘`--resign-allowed`’
GNU Go will resign lost games. This is the default.

3.9.2 Monte Carlo Options

GNU Go can play Monte Carlo Go on a 9x9 board. (Not available for larger boards.) It makes quite a strong engine. Here are the command line options.

- ‘`--monte-carlo`’
Use Monte Carlo move generation (9x9 or smaller).
- ‘`--mc-games-per-level <number>`’
Number of Monte Carlo simulations per level. Default 8000. Thus at level 10, GNU Go simulates 80,000 games in order to generate a move.
- ‘`--mc-list-patterns`’
list names of builtin Monte Carlo patterns
- ‘`--mc-patterns <name>`’
Choose a built in Monte Carlo pattern database. The argument can be ‘mc_mogo_classic’, ‘mc_montegnu_classic’ or ‘mc_uniform’.
- ‘`--mc-load-patterns <filename>`’
read Monte Carlo patterns from file

3.9.3 Other general options

- ‘-M’, ‘--cache-size *megs*’

Memory in megabytes used for caching of read results. The default size is 8 unless you configure gnugo with the command `configure --enable-cache-size=size` before compiling to make *size* the default (see [Chapter 2 \[Installation\], page 5](#)). GNU Go stores results of its reading calculations in a hash table (see [Section 11.2 \[Hashing\], page 113](#)). If the hash table is filled, it is emptied and the reading continues, but some reading may have to be repeated that was done earlier, so a larger cache size will make GNU Go run faster, provided the cache is not so large that swapping occurs. Swapping may be detected on GNU/Linux machines using the program `top`. However, if you have ample memory or if performance seems to be a problem you may want to increase the size of the cache using this option.
- ‘--chinese-rules’

Use Chinese rules. This means that the Chinese or Area Counting is followed. It may affect the score of the game by one point in even games, more if there is a handicap (since in Chinese Counting the handicap stones count for Black) or if either player passes during the game.
- ‘--japanese-rules’

Use Japanese Rules. This is the default unless you specify ‘--enable-chinese-rules’ as a configure option.
- ‘--play-out-aftermath’
- ‘--capture-all-dead’

These options cause GNU Go to play out moves that are usually left unplayed after the end of the game. Such moves lose points under Japanese rules but not Chinese rules. With ‘--play-out-aftermath’, GNU Go may play inside its territory in order to reach a position where it considers every group demonstrably alive or dead. The option ‘--capture-all-dead’ causes GNU Go to play inside its own territory to remove dead stones.
- ‘--forbid-suicide’

Do not allow suicide moves (playing a stone so that it ends up without liberties and is therefore immediately removed). This is the default.
- ‘--allow-suicide’

Allow suicide moves, except single-stone suicide. The latter would not change the board at all and pass should be used instead.
- ‘--allow-all-suicide’

Allow suicide moves, including single-stone suicide. This is only interesting in exceptional cases. Normally the ‘--allow-suicide’ option should be used instead.
- ‘--simple-ko’

Do not allow an immediate recapture of a ko so that the previous position is recreated. Repetition of earlier positions than that are allowed. This is default.

- ‘--no-ko’
Allow all kinds of board repetition.
- ‘--positional-superko’
Forbid repetition of any earlier board position. This only applies to moves on the board; passing is always allowed.
- ‘--situational-superko’
Forbid repetition of any earlier board position with the same player to move. This only applies to moves on the board; passing is always allowed.
- ‘--copyright’: Display the copyright notice
- ‘--version’ or ‘-v’: Print the version number
- ‘--printsgf *filename*’:
Create an SGF file containing a diagram of the board. Useful with ‘-1’ and ‘-L’ to create a diagram of the board from another sgf file. Illegal moves are indicated with the private IL property. This property is not used in the FF4 SGF specification, so we are free to preempt it.
- ‘--options’
Print which experimental configure options were compiled into the program (see [Section 2.2.3 \[Other Options\]](#), page 6).
- ‘--orientation *n*’
Combine with ‘-1’. The Go board can be oriented in 8 different ways, counting reflections and rotations of the position; this option selects an orientation (default 0). The parameter ‘*n*’ is an integer between 0 and 7.

3.9.4 Other options affecting strength and speed

- ‘--level *amount*’
The higher the level, the deeper GNU Go reads. Level 10 is the default. If GNU Go plays too slowly on your machine, you may want to decrease it.

This single parameter ‘--level’ is the best way of choosing whether to play stronger or faster. It controls a host of other parameters which may themselves be set individually at the command line. The default values of these parameters may be found by running `gnugo --help`.

Unless you are working on the program you probably don’t need the remaining options in this category. Instead, just adjust the single variable ‘--level’. The following options are of use to developers tuning the program for performance and accuracy. For completeness, here they are.

- ‘-D’, ‘--depth *depth*’
Deep reading cutoff. When reading beyond this depth (default 16) GNU Go assumes that any string which can obtain 3 liberties is alive. Thus GNU Go can read ladders to an arbitrary depth, but will miss other types of capturing moves.
- ‘-B’, ‘--backfill-depth *depth*’
Deep reading cutoff. Beyond this depth (default 12) GNU Go will no longer try backfilling moves in its reading.

- ‘`--backfill2-depth depth`’
Another depth controlling how deeply GNU Go looks for backfilling moves. The moves tried below `backfill2_depth` are generally more obscure and time intensive than those controlled by `backfill_depth`, so this parameter has a lower default.
- ‘`-F`’, ‘`--fourlib-depth depth`’
Deep reading cutoff. When reading beyond this depth (default 7) GNU Go assumes that any string which can obtain 4 liberties is alive.
- ‘`-K`’, ‘`--ko-depth depth`’
Deep reading cutoff. Beyond this depth (default 8) GNU Go no longer tries very hard to analyze kos.
- ‘`--branch-depth depth`’
This sets the `branch_depth`, typically a little below the `depth`. Between `branch_depth` and `depth`, attacks on strings with 3 liberties are considered but branching is inhibited, so fewer variations are considered. Below this depth (default 13), GNU Go still tries to attack strings with only 3 liberties, but only tries one move at each node.
- ‘`--break-chain-depth depth`’
Set the `break_chain_depth`. Beyond this depth, GNU Go abandons some attempts to defend groups by trying to capture part of the surrounding chain.
- ‘`--aa-depth depth`’
The reading function `atari_atari` looks for combinations beginning with a series of ataris, and culminating with some string having an unexpected change in status (e.g. alive to dead or critical). This command line option sets the parameter `aa_depth` which determines how deeply this function looks for combinations.
- ‘`--superstring-depth`’
A superstring (see [Section 11.8 \[Superstrings\], page 122](#)) is an amalgamation of tightly strings. Sometimes the best way to attack or defend a string is by attacking or defending an element of the superstring. Such tactics are tried below `superstring_depth` and this command line option allows this parameter to be set.

The preceding options are documented with the reading code (see [Section 11.1 \[Reading Basics\], page 111](#)).

- ‘`--owl-branch`’ Below this depth Owl only considers one move. Default 8.
- ‘`--owl-reading`’ Below this depth Owl assumes the dragon has escaped. Default 20.
- ‘`--owl-node-limit`’
If the number of variations exceeds this limit, Owl assumes the dragon can make life. Default 1000. We caution the user that increasing `owl_node_limit` does not necessarily increase the strength of the program.

- ‘`--owl-node-limit n`’
If the number of variations exceeds this limit, Owl assumes the dragon can make life. Default 1000. We caution the user that increasing `owl_node_limit` does not necessarily increase the strength of the program.
- ‘`--owl-distrust n`’
Below this limit some owl reading is truncated.

3.9.5 Ascii mode options

- ‘`--color color`’
Choose your color (‘black’ or ‘white’).
- ‘`--handicap number`’
Choose the number of handicap stones (0–9)

For more information about the following clock options see See [Section 3.4 \[Ascii\]](#), [page 13](#).

- ‘`--clock seconds`’
Initialize the timer.
- ‘`--byo-time seconds`’
Number of seconds per (Canadian) byo-yomi period
- ‘`--byo-period stones`’
Number of stones per (Canadian) byo-yomi period

3.9.6 Development options

- ‘`--replay color`’
Replay all moves in a game for either or both colors. If used with the ‘`-o`’ option the game record is annotated with move values. This option requires ‘`-l filename`’. The color can be:
 - white: replay white moves only
 - black: replay black moves only
 - both: replay all moves

When the move found by `genmove` differs from the move in the `sgf` file the values of both moves are reported thus:

```
Move 13 (white): GNU Go plays C6 (20.60) - Game move F4 (20.60)
```

This option is useful if one wants to confirm that a change such as a speedup or other optimization has not affected the behavior of the engine. Note that when several moves have the same top value (or nearly equal) the move generated is not deterministic (though it can be made deterministic by starting with the same random seed). Thus a few deviations from the move in the `sgf` file are to be expected. Only if the two reported values differ should we conclude that the engine plays differently from the engine which generated the `sgf` file. See [Chapter 20 \[Regression\]](#), [page 202](#).

- ‘-a’, ‘--allpats’
Test all patterns, even those smaller in value than the largest move found so far. This should never affect GNU Go’s final move, and it will make it run slower. However this can be very useful when "tuning" GNU Go. It causes both the traces and the output file (‘-o’) to be more informative.
- ‘-T’, ‘--printboard’: colored display of dragons.
Use rxvt, xterm or Linux Console. (see [Section 5.8 \[Colored Display\], page 38](#))
- ‘--showtime’
Print timing information to stderr.
- ‘-E’, ‘--printeyes’: colored display of eye spaces
Use rxvt, xterm or Linux Console. (see [Section 5.8 \[Colored Display\], page 38](#))
- ‘-d’, ‘--debug level’
Produce debugging output. The debug level is given in hexadecimal, using the bits defined in the following table from ‘engine/gnugo.h’. A list of these may be produced using ‘--debug-flags’. Here they are in hexadecimal:

DEBUG_INFLUENCE	0x0001
DEBUG_EYES	0x0002
DEBUG_OWL	0x0004
DEBUG_ESCAPE	0x0008
DEBUG_MATCHER	0x0010
DEBUG_DRAGONS	0x0020
DEBUG_SEMEAI	0x0040
DEBUG_LOADSGF	0x0080
DEBUG_HELPER	0x0100
DEBUG_READING	0x0200
DEBUG_WORMS	0x0400
DEBUG_MOVE_REASONS	0x0800
DEBUG_OWL_PERFORMANCE	0x1000
DEBUG_LIFE	0x2000
DEBUG_FILLLIB	0x4000
DEBUG_READING_PERFORMANCE	0x8000
DEBUG_SCORING	0x010000
DEBUG_AFTERMATH	0x020000
DEBUG_ATARI_ATARI	0x040000
DEBUG_READING_CACHE	0x080000
DEBUG_TERRITORY	0x100000
DEBUG_OWL_PERSISTENT_CACHE	0x200000
DEBUG_TOP_MOVES	0x400000
DEBUG_MISCELLANEOUS	0x800000
DEBUG_ORACLE_STREAM	0x1000000

These debug flags are additive. If you want to turn on both dragon and worm debugging you can use ‘-d0x420’.

- ‘--debug-flags’
Print the list of debug flags
- ‘-w’, ‘--worms’
Print more information about worm data.
- ‘-m’, ‘--moyo *level*’
moyo debugging, show moyo board. The *level* is fully documented elsewhere (see [Section 13.13 \[Influential Display\]](#), page 143).
- ‘-b’, ‘--benchmark *number*’
benchmarking mode - can be used with ‘-1’. Causes GNU Go to play itself repeatedly, seeding the start of the game with a few random moves. This method of testing the program is largely superseded by use of the `twogtp` program.
- ‘-S’, ‘--statistics’
Print statistics (for debugging purposes).
- ‘-t’, ‘--trace’
Print debugging information. Use twice for more detail.
- ‘-r’, ‘--seed *seed*’
Set random number seed. This can be used to guarantee that GNU Go will make the same decisions on multiple runs through the same game. If *seed* is zero, GNU Go will play a different game each time.
- ‘--decide-string *location*’
Invoke the tactical reading code (see [Chapter 11 \[Tactical Reading\]](#), page 111 to decide whether the string at *location* can be captured, and if so, whether it can be defended. If used with ‘-o’, this will produce a variation tree in SGF.
- ‘--decide-owl *location*’
Invoke the owl code (see [Section 12.1 \[The Owl Code\]](#), page 126) to decide whether the dragon at *location* can be captured, and whether it can be defended. If used with ‘-o’, this will produce a variation tree in SGF.
- ‘--decide-connection *location1/location2*’
Decide whether dragons at *location1* and *location2* can be connected. Useful in connection with ‘-o’ to write the variations to an SGF file.
- ‘--decide-dragon-data *location*’
Print complete information about the status of the dragon at *location*.
- ‘--decide-semeai *location1/location2*’
At *location1* and *location2* are adjacent dragons of the opposite color. Neither is alive by itself, and their fate (alive, dead or seki) depends on the outcome of a semeai (capturing race). Decide what happens. Useful in connection with ‘-o’ to write the variations to an SGF file.
- ‘--decide-tactical-semeai *location1/location2*’
Similar to ‘--decide-semeai’, except that moves proposed by the owl code are not considered.

- ‘--decide-position’

Try to attack and defend every dragon with `dragon.escape<6`. If used with ‘-o’, writes the variations to an `sgf` file.
- ‘--decide-eye *location*’

Evaluates the eyespace at *location* and prints a report. You can get more information by adding ‘-d0x02’ to the command line. (see [Section 8.7 \[Eye Local Game Values\]](#), page 66.)
- ‘--decide-surrounded *location*’

A dragon is *surrounded* if it is contained in the convex hull of its unfriendly neighbor dragons. This does not mean that it cannot escape, but it is often a good indicator that the dragon is under attack. This option draws the convex hull of the neighbor dragons and decides whether the dragon at *location* is surrounded.
- ‘--decide-combination’

Calls the function `atari_atari` to decide whether there exist combinations on the board.
- ‘--score *method*’

Requires ‘-1’ to specify which game to score and ‘-L’ if you want to score anywhere else than at the end of the game record. *method* can be "estimate", "finish", or "aftermath". "finish" and "aftermath" are appropriate when the game is complete, or nearly so, and both try to supply an accurate final score. Notice that if the game is not already finished it will be played out, which may take quite a long time if the game is far from complete. The "estimate" method may be used to get a quick estimate during the middle of the game. Any of these options may be combined with ‘--chinese-rules’ if you want to use Chinese (Area) counting.

If the option ‘-o *outputfilename*’ is provided, the result will also be written as a comment in the output file. For the "finish" and "aftermath" scoring algorithms, the selfplayed moves completing the game are also stored.

 - finish

Finish the game by selfplaying until two passes, then determine the status of all stones and compute territory.
 - aftermath

Finish the game by selfplaying until two passes, then accurately determine status of all stones by playing out the "aftermath", i.e. playing on until all stones except ones involved in *seki* have become either unconditionally (in the strongest sense) alive or unconditionally dead (or captured). Slower than ‘--score finish’, and while these algorithms usually agree, if they differ, ‘--score aftermath’ is most likely to be correct.
- --score aftermath --capture-all-dead --chinese-rules

This combination mandates **Tromp-Taylor** scoring. The Tromp-Taylor ruleset requires the game to be played out until all dead stones are removed,

then uses area (Chinese) scoring. The option ‘`--capture-all-dead`’ requires the aftermath code to finish capturing all dead stones.

3.9.7 Experimental options

Most of these are available as configure options and are described in [Section 2.2.3 \[Other Options\]](#), page 6.

- ‘`--options`’
Print which experimental configure options were compiled into the program.
- ‘`--with-break-in`’
- ‘`--without-break-in`’
Use or do not use the experimental break-in code. This option has no effect at level 9 or below. The break in code is enabled by default at level 10, and the only difference between levels 9 and level 10 is that the break in code is disabled at level 9.
- ‘`--cosmic-gnugo`’
Use center oriented influence.
- ‘`--nofusekidb`’
Turn off the fuseki database.
- ‘`--nofuseki`’
Turn off fuseki moves entirely
- ‘`--nojosekidb`’
Turn off the joseki database.
- ‘`--mirror`’
Try to play mirror go.
- ‘`--mirror-limit n`’
Stop mirroring when n stones are on the board.

4 GNU Go engine overview

This chapter is an overview of the GNU Go internals. Further documentation of how any one module or routine works may be found in later chapters or comments in the source files.

GNU Go starts by trying to understand the current board position as good as possible. Using the information found in this first phase, and using additional move generators, a list of candidate moves is generated. Finally, each of the candidate moves is valued according to its territorial value (including captures or life-and-death effects), and possible strategical effects (such as strengthening a weak group).

Note that while GNU Go does, of course, do a lot of reading to analyze possible captures, life and death of groups etc., it does not (yet) have a fullboard lookahead.

4.1 Gathering Information

This is by far the most important phase in the move generation. Misunderstanding life-and-death situations can cause gross mistakes. Wrong territory estimates will lead to inaccurate move valuations. Bad judgement of weaknesses of groups make strategic mistakes likely.

This information gathering is done by the function `examine_position()`. It first calls `make_worms()`.

Its first steps are very simple: it identifies sets of directly connected stones, called *worms*, and notes their sizes and their number of liberties.

Soon after comes the most important step of the worm analysis: the tactical reading code (see [Chapter 11 \[Tactical Reading\], page 111](#)) is called for every worm. It tries to read out which worms can be captured directly, giving up as soon as a worm can reach 5 liberties. If a worm can be captured, the engine of course looks for moves defending against this capture. Also, a lot of effort is made to find virtually all moves that achieve the capture or defense of a worm.

After knowing which worms are tactically stable, we can make a first picture of the balance of power across the board: the [Chapter 13 \[Influence\], page 129](#) code is called for the first time.

This is to aid the next step, the analysis of dragons. By a *dragon* we mean a group of stones that cannot be disconnected.

Naturally the first step in the responsible function `make_dragons()` is to identify these dragons, i.e. determine which worms cannot be disconnected from each other. This is partly done by patterns, but in most cases the specialized `readconnect` code is called. This module does a minimax search to determine whether two given worms can be connected with, resp. disconnected from each other.

Then we compute various measures to determine how strong or weak any given dragon is:

- A crude estimate of the number of eyes is made.
- The results of the influence computations is used to see which dragons are adjacent to own territory or a moyo.
- A guess is made for the potential to escape if the dragon got under attack.

For those dragons that are considered weak, a life and death analysis is made (see [Section 12.1 \[The Owl Code\], page 126](#)). If two dragons next to each other are found that are both not alive, we try to resolve this situation with the `semeai` module.

For a more detailed reference of the worm and dragon analysis (and explanations of the data structures used to store the information), see [Chapter 7 \[Worms and Dragons\], page 47](#).

The influence code is then called second time to make a detailed analysis of likely territory. Of course, the life-and-death status of dragons are now taken into account.

The territorial results of the influence module get corrected by the break-in module. This specifically tries to analyze where an opponent could break into an alleged territory, with sequences that would be too difficult to see for the influence code.

4.2 Move Generators

Once we have found out all about the position it is time to generate the best move. Moves are proposed by a number of different modules called *move generators*. The move generators themselves do not set the values of the moves, but enumerate justifications for them, called *move reasons*. The valuation of the moves comes last, after all moves and their reasons have been generated.

For a list and explanation of move reasons used in GNU Go, and how they are evaluated, see [Chapter 6 \[Move Generation\], page 40](#).

There are a couple of move generators that only extract data found in the previous phase, examining the position:

- `worm_reasons()`
Moves that have been found to capture or defend a worm are proposed as candidates.
- `owl_reasons()`
The status of every dragon, as it has been determined by the owl code (see [Section 12.1 \[The Owl Code\], page 126](#)) in the previous phase, is reviewed. If the status is critical, the killing or defending move gets a corresponding move reason.
- `semeai_move_reasons()`
Similarly as `owl_reasons`, this function proposes moves relevant for `semeais`.
- `break_in_move_reasons()`
This suggests moves that have been found to break into opponent's territory by the break-in module.

The following move generators do additional work:

- `fuseki()`
Generate a move in the early fuseki, either in an empty corner or from the fuseki database.
- `shapes()`
This is probably the most important move generator. It finds patterns from `'patterns/patterns.db'`, `'patterns/patterns2.db'`,

‘`patterns/fuseki.db`’, and the joseki files in the current position. Each pattern is matched in each of the 8 possible orientations obtainable by rotation and reflection. If the pattern matches, a so called "constraint" may be tested which makes use of reading to determine if the pattern should be used in the current situation. Such constraints can make demands on number of liberties of strings, life and death status, and reading out ladders, etc. The patterns may call helper functions, which may be hand coded (in ‘`patterns/helpers.c`’) or autogenerated.

The patterns can be of a number of different classes with different goals. There are e.g. patterns which try to attack or defend groups, patterns which try to connect or cut groups, and patterns which simply try to make good shape. (In addition to the large pattern database called by `shapes()`, pattern matching is used by other modules for different tasks throughout the program. See [Chapter 9 \[Patterns\]](#), page 77, for a complete documentation of patterns.)

- `combinations()`
See if there are any combination threats or atari sequences and either propose them or defend against them.
- `revise_thrashing_dragon()`
This module does not directly propose move: If we are clearly ahead, and the last move played by the opponent is part of a dead dragon, we want to attack that dragon again to be on the safe side. This is done by setting the status of this *thrashing dragon* to unknown and repeating the shape move generation and move valuation.
- `endgame_shapes()`
If no move is found with a value greater than 6.0, this module matches a set of extra patterns which are designed for the endgame. The endgame patterns can be found in ‘`patterns/endgame.db`’.
- `revise_semeai()`
If no move is found, this module changes the status of opponent groups involved in a semeai from DEAD to UNKNOWN. After this, `genmove` runs `shapes` and `endgame_shapes` again to see if a new move turns up.
- `fill_liberty()`
Fill a common liberty. This is only used at the end of the game. If necessary a backfilling or backcapturing move is generated.

4.3 Move Valuation

After the move generation modules have run, each proposed candidate move goes through a detailed valuation by the function `review_move_reasons`. This invokes some analysis to try to turn up other move reasons that may have been missed.

The most important value of a move is its territorial effect. see [Section 13.4 \[Influence and Territory\]](#), page 131 explains in detail how this is determined.

This value is modified for all move reasons that cannot be expressed directly in terms of territory, such as combination attacks (where it is not clear which of several strings will

get captured), strategical effects, connection moves, etc. A large set heuristics is necessary here, e.g. to avoid duplication of such values. This is explained in more detail in [Section 6.4 \[Valuation\]](#), page 44.

4.4 Detailed Sequence of Events

First comes the sequence of events when `examine_position()` is run from `genmove()`. This is for reference only.

```

purge_persistent_caches()
make_worms():
  compute_effective_sizes()
  compute_unconditional_status()
  find_worm_attacks_and_defenses():
    for each attackable worm:
      set worm.attack
      change_attack() to add the attack point
      find_attack_patterns() to find a few more attacks
    for each defensible worm:
      set worm.attack
      change_defense() to add the defense point
      find_defense_patterns() to find a few more defense moves
  find additional attacks and defenses by testing all
    immediate liberties
  find higher order liberties (for each worm)
  find cutting stones (for each worm)
  improve attacks and defenses: if capturing a string defends
    another friendly string, or kills an unfriendly one, we
    add points of defense or attack. Make repairs if adjacent
    strings can both be attacked but not defended.
  find worm lunches
  find worm threats
  identify inessential worms (such as nakade stones)
compute_worm_influence():
  find_influence_patterns()
  value_influence()
  segment_influence()
make_dragons():
  find_cuts()
  find_connections()
  make_domains() (determine eyeshapes)
  find_lunches() (adjacent strings that can be captured)
  find_half_and_false_eyes()
  eye_computations(): Compute the value of each eye space.
    Store its attack and defense point.
  analyze_false_eye_territory()
  for each dragon compute_dragon_genus()
  for each dragon compute_escape() and set escape route data

```

```

resegment_initial_influence()
compute_refined_dragon_weaknesses() (called again after owl)
for each dragon compute_crude_status()
find_neighbor_dragons()
for each dragon compute surround status
for each weak dragon run owl_attack() and owl_defend()
    to determine points of attack and defense
for each dragon compute dragon.status
for each thrashing dragon compute owl threats
for each dragon compute dragon.safety
revise_inessentiality()
semeai():
    for every semeai, run owl_analyze_semeai()
    find_moves_to_make_seki()
identify_thrashing_dragons()
compute_dragon_influence():
    compute_influence()
    break_territories() (see Section 13.10 \[Break Ins\], page 138)
compute_refined_dragon_weaknesses()

```

Now a summary of the sequence of events during the move generation and selection phases of `genmove()`, which take place after the information gathering phase has been completed:

```

estimate_score()
choose_strategy()
collect_move_reasons():
    worm_reasons(): for each attack and defense point add a move reason
    semeai_reasons(): for each dragon2.semeai point add a move reason
    owl_reasons(): for each owl attack and defense point add a move reason
    break_in_reasons(): for each breakin found add a move reason
fuseki()
break_mirror_go()
shapes(): match patterns around the board (see Section 9.1 \[Patterns Overview\], page 77)
combinations(): look for moves with a double meaning and other tricks
    find_double_threats()
    atari_atari()
review_move_reasons()
if ahead and there is a thrashing dragon, consider it
    alive and reconsider the position
endgame_shapes()
endgame()
if no move found yet, revisit any semeai, change status of dead opponent
    to alive, then run shapes() and endgame_shapes() again
if no move found yet, run fill_liberty()

```

4.5 Roadmap

The GNU Go engine is contained in two directories, `engine/` and `patterns/`. Code related to the user interface, reading and writing of Smart Game Format files, and testing are found in the directories `interface/`, `sgf/`, and `regression/`. Code borrowed from other GNU programs is contained in `utils/`. That directory also includes some code developed within GNU Go which is not go specific. Documentation is in `doc/`.

In this document we will describe some of the individual files comprising the engine code in `engine/` and `patterns/`. In `interface/` we mention two files:

- `gmp.c`

This is the Go Modem Protocol interface (courtesy of William Shubert and others). This takes care of all the details of exchanging setup and moves with Cgoban, or any other driving program recognizing the Go Modem Protocol.

- `main.c`

This contains `main()`. The `gnugo` target is thus built in the `interface/` directory.

4.5.1 Files in `engine/`

In `engine/` there are the following files:

- `aftermath.c`

Contains algorithms which may be called at the end of the game to generate moves that will generate moves to settle the position, if necessary playing out a position to determine exactly the status of every group on the board, which GNU Go can get wrong, particularly if there is a seki. This module is the basis for the most accurate scoring algorithm available in GNU Go.

- `board.c`

This file contains code for the maintenance of the board. For example it contains the important function `trymove()` which tries a move on the board, and `popgo()` which removes it by popping the move stack. At the same time vital information such as the number of liberties for each string and their location is updated incrementally.

- `breakin.c`

Code to detect moves which can break into supposed territory and moves to prevent this.

- `cache.c` and `cache.h`

As a means of speeding up reading, computed results are cached so that they can be quickly reused if the same position is encountered through e.g. another move ordering. This is implemented using a hash table.

- `clock.c` and `clock.h`

Clock code, including code allowing GNU Go to automatically adjust its level in order to avoid losing on time in tournaments.

- ‘`combination.c`’

When something can (only) be captured through a series of ataris or other threats we call this a combination attack. This file contains code to find such attacks and moves to prevent them.
- ‘`dragon.c`’

This contains `make_dragons()`. This function is executed before the move-generating modules `shapes()` `semeai()` and the other move generators but after `make_worms()`. It tries to connect worms into dragons and collect important information about them, such as how many liberties each has, whether (in GNU Go’s opinion) the dragon can be captured, if it lives, etc.
- ‘`endgame.c`’

Code to find certain types of endgame moves.
- ‘`filllib.c`’

Code to force filling of dame (backfilling if necessary) at the end of the game.
- ‘`fuseki.c`’

Generates fuseki (opening) moves from a database. Also generates moves in empty corners.
- ‘`genmove.c`’

This file contains `genmove()` and its supporting routines, particularly `examine_position()`.
- ‘`globals.c`’

This contains the principal global variables used by GNU Go.
- ‘`gnugo.h`’

This file contains declarations forming the public interface to the engine.
- ‘`hash.c`’ and ‘`hash.h`’

Hashing code implementing Zobrist hashing. (see [Section 11.2 \[Hashing\], page 113](#)) The code in ‘`hash.c`’ provides a way to hash board positions into compact descriptions which can be efficiently compared. The caching code in ‘`cache.c`’ makes use of the board hashes when storing and retrieving read results.
- ‘`influence.c`’ and ‘`influence.h`’

This code determines which regions of the board are under the influence of either player. (see [Chapter 13 \[Influence\], page 129](#))
- ‘`liberty.h`’

Header file for the engine. The name “liberty” connotes freedom (see [Appendix A \[Copying\], page 207](#)).
- ‘`matchpat.c`’

This file contains the pattern matcher `matchpat()`, which looks for patterns at a particular board location. The actual patterns are in the ‘`patterns/`’ directory. The function `matchpat()` is called by every module which does pattern matching, notably `shapes`.

- ‘`move_reasons.c`’ and ‘`move_reasons.h`’
Code for keeping track of move reasons.
- ‘`movelist.c`’
Supporting code for lists of moves.
- ‘`optics.c`’
This file contains the code to recognize eye shapes, documented in See [Chapter 8 \[Eyes\]](#), page 60.
- ‘`oracle.c`’
Code to fork off a second GNU Go process which can be used to simulate reading with top level information (e.g. dragon partitioning) available.
- ‘`owl.c`’
This file does life and death reading. Move generation is pattern based and the code in ‘`optics.c`’ is used to evaluate the eyespaces for vital moves and independent life. A dragon can also live by successfully escaping. Semeai reading along the same principles is also implemented in this file.
- ‘`persistent.c`’
Persistent cache which allows reuse of read results at a later move or with additional stones outside an active area, which are those intersections thought to affect the read result.
- ‘`printutils.c`’
Print utilities.
- ‘`readconnect.c`’ and ‘`readconnect.h`’
This file contains code to determine whether two strings can be connected or disconnected.
- ‘`reading.c`’
This file contains code to determine whether any given string can be attacked or defended. See [Chapter 11 \[Tactical Reading\]](#), page 111, for details.
- ‘`semeai.c`’
This file contains `semeai()`, the module which detects dragons in semeai. To determine the semeai results the semeai reading in ‘`owl.c`’ is used.
- ‘`sgfdecide.c`’
Code to generate sgf traces for various types of reading.
- ‘`shapes.c`’
This file contains `shapes()`, the module called by `genmove()` which tries to find moves which match a pattern (see [Chapter 9 \[Patterns\]](#), page 77).
- ‘`showbord.c`’
This file contains `showboard()`, which draws an ASCII representation of the board, depicting dragons (stones with same letter) and status (color). This was the primary interface in GNU Go 1.2, but is now a debugging aid.

- `'surround.c'`
Code to determine whether a dragon is surrounded and to find moves to surround with or break out with.
- `'utils.c'`
An assortment of utilities, described in greater detail below.
- `'value_moves.c'`
This file contains the code which assigns values to every move after all the move reasons are generated. It also tries to generate certain kinds of additional move reasons.
- `'worm.c'`
This file contains `make_worms()`, code which is run at the beginning of each move cycle, before the code in `'dragon.c'`, to determine the attributes of every string. These attributes are things like liberties, whether the string can be captured (and how), etc

4.5.2 Files in `'patterns/'`

The directory `'patterns/'` contains files related to pattern matching. Currently there are several types of patterns. A partial list:

- move generation patterns in `'patterns.db'` and `'patterns2.db'`
- move generation patterns in files `'hoshi.db'` etc. which are automatically build from the files `'hoshi.sgf'` etc. These comprise our small Joseki library.
- patterns in `'owl_attackpats.db'`, `'owl_defendpats.db'` and `'owl_vital_apats.db'`. These generate moves for the owl code (see [Section 12.1 \[The Owl Code\]](#), page 126).
- Connection patterns in `'conn.db'` (see [Section 9.9 \[Connections Database\]](#), page 90)
- Influence patterns in `'influence.db'` and `'barriers.db'` (see [Chapter 13 \[Influence\]](#), page 129)
- eye patterns in `'eyes.db'` (see [Chapter 8 \[Eyes\]](#), page 60).

The following list contains, in addition to distributed source files some intermediate automatically generated files such as `'patterns.c'`. These are C source files produced by "compiling" various pattern databases, or in some cases (such as `'hoshi.db'`) themselves automatically generated pattern databases produced by "compiling" joseki files in Smart Game Format.

- `'conn.db'`
Database of connection patterns.
- `'conn.c'`
Automatically generated file, containing connection patterns in form of struct arrays, compiled by `mkpat` from `'conn.db'`.
- `'eyes.c'`
Automatically generated file, containing eyeshape patterns in form of struct arrays, compiled by `mkpat` from `'eyes.db'`.
- `'eyes.h'`
Header file for `'eyes.c'`.

- `'eyes.db'`
Database of eyeshape patterns. See [Chapter 8 \[Eyes\]](#), page 60, for details.
- `'helpers.c'`
These are helper functions to assist in evaluating moves by matchpat.
- `'hoshi.sgf'`
Smart Game Format file containing 4-4 point openings
- `'hoshi.db'`
Automatically generated database of 4-4 point opening patterns, make by compiling `'hoshi.sgf'`
- `'joseki.c'`
Joseki compiler, which takes a joseki file in Smart Game Format, and produces a pattern database.
- `'komoku.sgf'`
Smart Game Format file containing 3-4 point openings
- `'komoku.db'`
Automatically generated database of 3-4 point opening patterns, make by compiling `'komoku.sgf'`
- `'mkeyes.c'`
Pattern compiler for the eyeshape databases. This program takes `'eyes.db'` as input and produces `'eyes.c'` as output.
- `'mkpat.c'`
Pattern compiler for the move generation and connection databases. Takes the file `'patterns.db'` together with the autogenerated Joseki pattern files `'hoshi.db'`, `'komoku.db'`, `'sansan.db'`, `'mokuhadzushi.db'`, `'takamoku.db'` and produces `'patterns.c'`, or takes `'conn.db'` and produces `'conn.c'`.
- `'mokuhadzushi.sgf'`
Smart Game Format file containing 5-3 point openings
- `'mokuhadzushi.db'`
Pattern database compiled from `mokuhadzushi.sgf`
- `'sansan.sgf'`
Smart Game Format file containing 3-3 point openings
- `'sansan.db'`
Pattern database compiled from `'sansan.sgf'`
- `'takamoku.sgf'`
Smart Game Format file containing 5-4 point openings
- `'takamoku.db'`
Pattern database compiled from `takamoku.sgf`.
- `'patterns.c'`
Pattern data, compiled from `patterns.db` by `mkpat`.

- ‘patterns.h’
Header file relating to the pattern databases.
- ‘patterns.db’ and ‘patterns2.db’
These contain pattern databases in human readable form.

4.6 Coding styles and conventions

4.6.1 Coding Conventions

Please follow the coding conventions at: http://www.gnu.org/prep/standards_toc.html

Please preface every function with a brief description of its usage.

Please help to keep this Texinfo documentation up-to-date.

4.6.2 Tracing

A function `gprintf()` is provided. It is a cut-down `printf`, supporting only `%c`, `%d`, `%s`, and without field widths, etc. It does, however, add some useful facilities:

- `%m`
Takes two parameters, and displays a formatted board co-ordinate.
- indentation
Trace messages are automatically indented to reflect the current stack depth, so it is clear during read-ahead when it puts a move down or takes one back.
- "outdent"
As a workaround, `%o` at the beginning of the: format string suppresses the indentation.

Normally `gprintf()` is wrapped in one of the following:

`TRACE(fmt, ...):`

Print the message if the ‘verbose’ variable > 0. (verbose is set by `-t` on the command line)

`DEBUG(flags, fmt, ...):`

While `TRACE` is intended to afford an overview of what GNU Go is considering, `DEBUG` allows occasional in depth study of a module, usually needed when something goes wrong. `flags` is one of the `DEBUG_*` symbols in ‘engine/gnugo.h’. The `DEBUG` macro tests to see if that bit is set in the `debug` variable, and prints the message if it is. The debug variable is set using the `-d` command-line option.

The variable `verbose` controls the tracing. It can equal 0 (no trace), 1, 2, 3 or 4 for increasing levels of tracing. You can set the trace level at the command line by ‘`-t`’ for `verbose=1`, ‘`-t -t`’ for `verbose=2`, etc. But in practice if you want more verbose tracing than level 1 it is better to use GDB to reach the point where you want the tracing; you will often find that the variable `verbose` has been temporarily set to zero and you can use the GDB command `set var verbose=1` to turn the tracing back on.

4.6.3 Assertions

Related to tracing are assertions. Developers are strongly encouraged to pepper their code with assertions to ensure that data structures are as they expect. For example, the helper functions make assertions about the contents of the board in the vicinity of the move they are evaluating.

`ASSERT()` is a wrapper around the standard C `assert()` function. In addition to the test, it takes an extra pair of parameters which are the co-ordinates of a "relevant" board position. If an assertion fails, the board position is included in the trace output, and `showboard()` and `popgo()` are called to unwind and display the stack.

4.6.4 FIXME

We have adopted the convention of putting the word `FIXME` in comments to denote known bugs, etc.

4.7 Navigating the Source

If you are using Emacs, you may find it fast and convenient to use Emacs' built-in facility for navigating the source. Switch to the root directory '`gnugo-3.6/`' and execute the command:

```
find . -print|grep "\.[ch]$" | xargs etags
```

This will build a file called '`gnugo-3.6/TAGS`'. Now to find any GNU Go function, type `M-.` and enter the command which you wish to find, or just `RET` if the cursor is at the name of the function sought.

The first time you do this you will be prompted for the location of the `TAGS` table. Enter the path to '`gnugo-3.6/TAGS`', and henceforth you will be able to find any function with a minimum of keystrokes.

5 Analyzing GNU Go's moves

In this chapter we will discuss methods of finding out how GNU Go understands a given position. These methods will be of interest to anyone working on the program, or simply curious about its workings.

In practice, most tuning of GNU Go is done in conjunction with maintaining the 'regression/' directory (see [Chapter 20 \[Regression\]](#), page 202).

We assume that you have a game GNU Go played saved as an sgf file, and you want to know why it made a certain move.

5.1 Interpreting Traces

A quick way to find out roughly the reason for a move is to run

```
gnugo -l filename -t -L move number
```

(You may also want to add '--quiet' to suppress the copyright message.) In GNU Go 3.6, the moves together with their reasons are listed, followed by a numerical analysis of the values given to each move.

If you are tuning (see [Section 9.11 \[Tuning\]](#), page 92) you may want to add the '-a' option. This causes GNU Go to report all patterns matched, even ones that cannot affect the outcome of the move. The reasons for doing this is that you may want to modify a pattern already matched instead of introducing a new one.

If you use the '-w' option, GNU Go will report the statuses of worms and dragons around the board. This type of information is available by different methods, however (see [Section 5.6 \[view.pike\]](#), page 38, see [Section 5.8 \[Colored Display\]](#), page 38).

5.2 The Output File

If GNU Go is invoked with the option '-o filename' it will produce an output file. This option can be added at the command line in the Go Modem Protocol Setup Window of CGoban. The output file will show the locations of the moves considered and their weights. It is worth noting that by enlarging the CGoban window to its fullest size it can display 3 digit numbers. Dragons with status DEAD are labelled with an 'X', and dragons with status CRITICAL are labelled with a '!'.

If you have a game file which is not commented this way, or which was produced by a non-current version of GNU Go you may ask GNU Go to produce a commented version by running:

```
gnugo --quiet -l <old file> --replay <color> -o <new file>
```

Here <color> can be 'black,' 'white' or 'both'. The replay option will also help you to find out if your current version of GNU Go would play differently than the program that created the file.

5.3 Checking the reading code

The '--decide-string' option is used to check the tactical reading code (see [Chapter 11 \[Tactical Reading\]](#), page 111). This option takes an argument, which is a location on the board in the usual algebraic notation (e.g. '--decide-string C17'). This will tell you

whether the reading code (in `engine/reading.c`) believes the string can be captured, and if so, whether it believes it can be defended, which moves it finds to attack or defend the move, how many nodes it searched in coming to these conclusions. Note that when GNU Go runs normally (not with `--decide-string`) the points of attack and defense are computed when `make_worms()` runs and cached in `worm.attack` and `worm.defend`.

If used with an output file (`-o filename`) `--decide-string` will produce a variation tree showing all the variations which are considered. This is a useful way of debugging the reading code, and also of educating yourself with the way it works. The variation tree can be displayed graphically using CGoban.

At each node, the comment contains some information. For example you may find a comment:

```
attack4-B at D12 (variation 6, hash 51180fdf)
break_chain D12: 0
defend3 D12: 1 G12 (trivial extension)
```

This is to be interpreted as follows. The node in question was generated by the function `attack3()` in `engine/reading.c`, which was called on the string at D12. The data in parentheses tell you the values of `count_variations` and `hashdata.hashval`.

The second value (“hash”) you probably will not need to know unless you are debugging the hash code, and we will not discuss it. But the first value (“variation”) is useful when using the debugger `gdb`. You can first make an output file using the `-o` option, then walk through the reading with `gdb`, and to coordinate the SGF file with the debugger, display the value of `count_variations`. Specifically, from the debugger you can find out where you are as follows:

```
(gdb) set dump_stack()
B:D13 W:E12 B:E13 W:F12 B:F11 (variation 6)
```

If you place yourself right after the call to `trymove()` which generated the move in question, then the variation number in the SGF file should match the variation number displayed by `dump_stack()`, and the move in question will be the last move played (F11 in this example).

This displays the sequence of moves leading up to the variation in question, and it also prints `count_variations-1`.

The second two lines tell you that from this node, the function `break_chain()` was called at D12 and returned 0 meaning that no way was found of rescuing the string by attacking an element of the surrounding chain, and the function `defend3()` was called also at D12 and returned 1, meaning that the string can be defended, and that G12 is the move that defends it. If you have trouble finding the function calls which generate these comments, try setting `sgf_dumptree=1` and setting a breakpoint in `sgf_trace`.

5.4 Checking the Owl Code

You can similarly debug the Owl code using the option `--decide-dragon`. Usage is entirely similar to `--decide-string`, and it can be used similarly to produce variation trees. These should be typically much smaller than the variation trees produced by `--decide-string`.

5.5 GTP and GDB techniques

You can use the Go Text Protocol (see [Chapter 19 \[GTP\], page 179](#)) to determine the statuses of dragons and other information needed for debugging. The GTP command `dragon_data P12` will list the dragon data of the dragon at P12 and `worm_data` will list the worm data; other GTP commands may be useful as well.

You can also conveniently get such information from GDB. A suggested `.gdbinit` file may be found in See [Section 11.9 \[Debugging\], page 122](#). Assuming this file is loaded, you can list the dragon data with the command:

```
(gdb) dragon P12
```

Similarly you can get the worm data with `worm P12`.

5.6 Debugging on a Graphical Board

The quickest way to analyze most positions is to use the tool `view.pike` in the `regression` directory. It can be started with a testcase specified, e.g. `pike view.pike strategy:40` or at a move in an sgf file, e.g. `pike view.pike mistake.sgf:125`. When started it shows the position on a graphical board on which it also marks information like move values, dragon status, and so on. By clicking on the board further information about the valuation of moves, contents of various data structures, and other data can be made available.

Specific information on how to use `view.pike` for influence tuning can be found in See [Section 13.14 \[Influence Tuning\], page 144](#).

5.7 Scoring the game

GNU Go can score the game. Normally GNU Go will report its opinion about the score at the end of the game, but if you want this information about a game stored in a file, use the `--score` option (see [Section 3.9 \[Invoking GNU Go\], page 14](#)).

5.8 Colored Display

Various colored displays of the board may be obtained in a color `xterm` or `rxvt` window. Xterm will only work if xterm is compiled with color support. If the colors are not displayed on your xterm, try rxvt. You may also use the Linux console. The colored display will work best if the background color is black; if this is not the case you may want to edit your `.Xdefaults` file or add the options `-bg black -fg white` to `xterm` or `rxvt`. On Mac OS X put `setenv TERM xterm-color` in your `.tcshrc` file to enable color in the terminal.

5.8.1 Dragon Display

You can get a colored ASCII display of the board in which each dragon is assigned a different letter; and the different `matcher_status` values (`ALIVE`, `DEAD`, `UNKNOWN`, `CRITICAL`) have different colors. This is very handy for debugging. Actually two diagrams are generated. The reason for this is concerns the way the matcher status is computed. The `dragon_status` (see [Section 7.5 \[Dragons\], page 54](#)) is computed first, then for some, but not all dragons, a more accurate owl status is computed. The matcher status is the owl status if available; otherwise it is the `dragon_status`. Both the `dragon_status` and the `owl_status` are displayed. The color scheme is as follows:

```
green = alive
cyan = dead
red = critical
yellow = unknown
magenta = unchecked
```

To get the colored display, save a game in sgf format using CGoban, or using the '-o' option with GNU Go itself.

Open an xterm or rxvt window.

Execute `gnugo -l [filename] -L [movenum] -T` to get the colored display.

Other useful colored displays may be obtained by using instead:

5.8.2 Eye Space Display

Instead of '-T', try this with '-E'. This gives a colored display of the eyespaces, with marginal eye spaces marked '!' (see [Chapter 8 \[Eyes\]](#), page 60).

6 Move generation

6.1 Introduction

GNU Go 3.0 introduced a move generation scheme substantially different from earlier versions. In particular, it was different from the method of move generation in GNU Go 2.6.

In the old scheme, various move generators suggested different moves with attached values. The highest such value then decided the move. There were two important drawbacks with this scheme:

- Efficient multipurpose moves could only be found by patterns which explicitly looked for certain combinations, such as a simultaneous connection and cut. There was also no good way to e.g. choose among several attacking moves.
- The absolute move values were increasingly becoming harder to tune with the increasing number of patterns. They were also fairly subjective and the tuning could easily break in unexpected ways when something changed, e.g. the worm valuation.

The basic idea of the new move generation scheme is that the various move generators suggest reasons for moves, e.g. that a move captures something or connects two strings, and so on. When all reasons for the different moves have been found, the valuation starts. The primary advantages are

- The move reasons are objective, in contrast to the move values in the old scheme. Anyone can verify whether a suggested move reason is correct.
- The centralized move valuation makes tuning easier. It also allows for style dependent tuning, e.g. how much to value influence compared to territory. Another possibility is to increase the value of safe moves in a winning position.

6.2 Generation of move reasons

Each move generator suggests a number of moves. It justifies each move suggestion with one or more *move reasons*. These move reasons are collected at each intersection where the moves are suggested for later valuation. Here is a partial list of move reasons considered by GNU Go. (The complete list may be found in ‘move_reasons.h’.)

ATTACK_MOVE

DEFEND_MOVE

Attack or defend a worm.

ATTACK_THREAT_MOVE

DEFEND_THREAT_MOVE

Threaten to attack or defend a worm.

EITHER_MOVE

A move that either achieves one goal or another (at the moment this only used for attacks on worms).

ALL_MOVE At the moment this is used for a move that defends two worms threatened by a double attack.

CONNECT_MOVE

CUT_MOVE Connect or cut two worms.

ANTISUJI_MOVE

Declare an antisuji or forbidden move.

SEMEAI_MOVE**SEMEAI_THREAT**

Win or threaten to win a semeai.

EXPAND_TERRITORY_MOVE**EXPAND_MOYO_MOVE**

Move expanding our territory/moyo. These reasons are at the moment treated identically.

VITAL_EYE_MOVE

A vital point for life and death.

STRATEGIC_ATTACK_MOVE**STRATEGIC_DEFEND_MOVE**

Moves added by 'a' and 'd' class patterns (see [Section 9.2 \[Pattern Classification\], page 78](#)) which (perhaps intangibly) attack or defend a dragon.

OWL_ATTACK_MOVE**OWL_DEFEND_MOVE**

An owl attack or defense move.

OWL_ATTACK_THREAT**OWL_DEFEND_THREAT**

A threat to owl attack or defend a group.

OWL_PREVENT_THREAT

A move to remove an owl threat.

UNCERTAIN_OWL_ATTACK**UNCERTAIN_OWL_DEFENSE**

An uncertain owl attack or defense. This means that the owl code could not decide the outcome, because the owl node limit was reached.

MY_ATARI_ATARI_MOVE

A move that starts a chain of ataris, eventually leading to a capture.

YOUR_ATARI_ATARI_MOVE

A move that if played by the opponent starts a chain of ataris for the opponent, leading to capture, which is also a safe move for us. Preemptively playing such a move almost always defends the threat.

The attack and defend move types can have a suffix to denote moves whose result depends on a ko, e.g. `OWL_ATTACK_MOVE_GOOD_KO`. Here `..._GOOD_KO` and `..._BAD_KO` correspond to `KO_A` and `KO_B` as explained in [Section 11.4 \[Ko\], page 117](#). See 'engine/move_reasons.h' for the full of move reasons.

NOTICE: Some of these are reasons for **not** playing a move.

More detailed discussion of these move reasons will be found in the next section.

6.3 Detailed Descriptions of various Move Reasons

6.3.1 Attacking and defending moves

A move which tactically captures a worm is called an *attack move* and a move which saves a worm from being tactically captured is called a *defense move*. It is understood that a defense move can only exist if the worm can be captured, and that a worm without defense only is attacked by moves that decrease the liberty count or perform necessary backfilling.

It is important that all moves which attack or defend a certain string are found, so that the move generation can make an informed choice about how to perform a capture, or find moves which capture and/or defend several worms.

Attacking and defending moves are first found in `make_worms` while it evaluates the tactical status of all worms, although this step only gives one attack and defense (if any) move per worm. Immediately after, still in `make_worms`, all liberties of the attacked worms are tested for additional attack and defense moves. More indirect moves are found by `find_attack_patterns` and `find_defense_patterns`, which match the A (attack) and D (defense) class patterns in `'patterns/attack.db'` and `'patterns/defense.db'` As a final step, all moves which fill some purpose at all are tested whether they additionally attacks or defends some worm. (Only unstable worms are analyzed.)

6.3.2 Threats to Attack or Defend

A threat to attack a worm, but where the worm can be defended is used as a secondary move reason. This move reason can enhance the value of a move so that it becomes sente. A threatening move without any other justification can also be used as a ko threat. The same is true for a move that threatens defense of a worm, but where the worm can still be captured if the attacker doesn't tenuki.

Threats found by the owl code are called **owl threats** and they have their own owl reasons.

6.3.3 Multiple attack or defense moves

Sometimes a move attacks at least one of a number of worms or simultaneously defends all of several worms. These moves are noted by their own move reasons.

6.3.4 Cutting and connecting moves

Moves which connect two distinct dragons are called **connecting moves**. Moves which prevent such connections are called *cutting moves*. Cutting and connecting moves are primarily found by pattern matching, the C and B class patterns.

A second source of cutting and connecting moves comes from the attack and defense of cutting stones. A move which attacks a worm automatically counts as a connecting move if there are multiple dragons adjacent to the attacked worm. Similarly a defending move counts as a cutting move. The action taken when a pattern of this type is found is to induce a connect or cut move reason.

When a cut or connect move reason is registered, the involved dragons are of course stored. Thus the same move may cut and/or connect several pairs of dragons.

6.3.5 Semeai winning moves

A move which is necessary to win a capturing race is called a *semeai move*. These are similar to attacking moves, except that they involve the simultaneous attack of one worm and the defense of another. As for attack and defense moves, it's important that all moves which win a semeai are found, so an informed choice can be made between them.

Semeai move reasons should be set by the semeai module. However this has not been implemented yet. One might also wish to list moves which increase the lead in a semeai race (removes ko threats) for use as secondary move reasons. Analogously if we are behind in the race.

6.3.6 Making or destroying eyes

A move which makes a difference in the number of eyes produced from an eye space is called an *eye move*. It's not necessary that the eye is critical for the life and death of the dragon in question, although it will be valued substantially higher if this is the case. As usual it's important to find all moves that change the eye count.

(This is part of what `eye_finder` was doing. Currently it only finds one vital point for each unstable eye space.)

6.3.7 Antisuji moves

Moves which are locally inferior or for some other reason must not be played are called *antisuji moves*. These moves are generated by pattern matching. Care must be taken with this move reason as the move under no circumstances will be played.

6.3.8 Territorial moves

Any move that increases territory gets a move reason. This is the expand territory move reason. That move reason is added by the 'e' patterns in 'patterns/patterns.db'. Similarly the 'E' patterns attempt to generate or mitigate a moyo, which is a region of influence not yet secure territory, yet valuable. Such a pattern sets the "expand moyo" move reason.

6.3.9 Attacking and Defending Dragons

Just as the tactical reading code tries to determine when a worm can be attacked or defended, the owl code tries to determine when a dragon can get two eyes and live. The function `owl_reasons()` generates the corresponding move reasons.

The owl attack and owl defense move reasons are self explanatory.

The owl attack threat reason is generated if owl attack on an opponent's dragon fails but the owl code determines that the dragon can be killed with two consecutive moves. The killing moves are stored in `dragon[pos].owl_attack_point` and `dragon[pos].owl_second_attack_point`.

Similarly if a friendly dragon is dead but two moves can revive it, an owl defense threat move reason is generated.

The prevent threat reasons are similar but with the colors reversed: if the opponent has an attack threat move then a move which removes the threat gets a prevent threat move reason.

The owl uncertain move reasons are generated when the owl code runs out of nodes. In order to prevent the owl code from running too long, a cap is put on the number of

nodes one owl read can generate. If this is exceeded, the reading is cut short and the result is cached as usual, but marked uncertain. In this case an owl uncertain move reason may be generated. For example, if the owl code finds the dragon alive but is unsure, a move to defend may still be generated.

6.3.10 Combination Attacks

The function `atari_atari` tries to find a sequence of ataris culminating in an unexpected change of status of any opponent string, from `ALIVE` to `CRITICAL`. Once such a sequence of ataris is found, it tries to shorten it by rejecting irrelevant moves.

6.4 Valuation of suggested moves

At the end of the move generation process, the function `value_move_reasons()` tries to assign values to the moves for the purpose of selecting the best move. The single purpose of the move valuation is to try to rank the moves so that the best move gets the highest score. In principle these values could be arbitrary, but in order to make it easier to evaluate how well the valuation performs, not to mention simplify the tuning, we try to assign values which are consistent with the usual methods of counting used by human Go players, as explained for example in *The Endgame* by Ogawa and Davies.

Moves are valued with respect to four different criteria. These are

- territorial value
- strategical value
- shape value,
- secondary value.

All of these are floats and should be measured in terms of actual points.

The territorial value is the total change of expected territory caused by this move. This includes changes in the status of groups if the move is an attack or a defense move.

Beginning with GNU Go 3.0, the influence function plays an important role in estimating territory (see [Section 13.4 \[Influence and Territory\], page 131](#)). It is used to make a guess at each intersection how likely it is that it will become black or white territory. The territorial value sums up the changes in these valuations.

Strategical value is a measure of the effect the move has on the safety of all groups on the board. Typically cutting and connecting moves have their main value here. Also edge extensions, enclosing moves and moves towards the center have high strategical value. The strategical value should be the sum of a fraction of the territorial value of the involved dragons. The fraction is determined by the change in safety of the dragon.

Shape value is a purely local shape analysis. An important role of this measure is to offset mistakes made by the estimation of territorial values. In open positions it's often worth sacrificing a few points of (apparent) immediate profit to make good shape. Shape value is implemented by pattern matching, the Shape patterns.

Secondary value is given for move reasons which by themselves are not sufficient to play the move. One example is to reduce the number of eyes for a dragon that has several or to attack a defenseless worm.

When all these values have been computed, they are summed, possibly weighted (secondary value should definitely have a small weight), into a final move value. This value is used to decide the move.

6.4.1 Territorial Value

The algorithm for computing territorial value is in the function `estimate_territorial_value`. As the name suggests, it seeks to estimate the change in territory.

It considers all groups that are changed from alive to death or vice-versa due to this move. Also, it makes an assumption whether the move should be considered safe. If so, the influence module is called: The function `influence_delta_territory` estimates the territorial effect of both the stone played and of the changes of group status'.

The result returned by the influence module is subject to a number of corrections. This is because some move reasons cannot be evaluated by a single call to the influence function, such as moves depending on a ko.

6.4.2 Strategical Value

Strategical defense or attack reasons are assigned to any move which matches a pattern of type 'a' or 'd'. These are moves which in some (often intangible) way tend to help strengthen or weaken a dragon. Of course strengthening a dragon which is already alive should not be given much value, but when the move reason is generated it is not necessary to check its status or safety. This is done later, during the valuation phase.

6.4.3 Shape Factor

In the value field of a pattern (see [Section 9.3 \[Pattern Values\], page 80](#)) one may specify a shape value.

This is used to compute the shape factor, which multiplies the score of a move. We take the largest positive contribution to shape and add 1 for each additional positive contribution found. Then we take the largest negative contribution to shape, and add 1 for each additional negative contribution. The resulting number is raised to the power 1.05 to obtain the shape factor.

The rationale behind this complicated scheme is that every shape point is very significant. If two shape contributions with values (say) 5 and 3 are found, the second contribution should be devalued to 1. Otherwise the engine is too difficult to tune since finding multiple contributions to shape can cause significant overvaluing of a move.

6.4.4 Minimum Value

A pattern may assign a minimum (and sometimes also a maximum) value. For example the Joseki patterns have values which are prescribed in this way, or ones with a `value` field. One prefers not to use this approach but in practice it is sometimes needed.

In the fuseki, there are often several moves with identical minimum value. GNU Go chooses randomly between such moves, which ensures some indeterminacy of GNU Go's play. Later in the game, GNU Go's genuine valuation of such a move is used as a secondary criterion.

6.4.5 Secondary Value

Secondary move reasons are weighed very slightly. Such a move can tip the scales if all other factors are equal.

6.4.6 Threats and Followup Value

Followup value refers to value which may accrue if we get two moves in a row in a local area. It is assigned for moves that threaten to attack or defend a worm or dragon. Also, since GNU Go 3.2 the influence module makes an assessment of the possible purely territorial followup moves. In cases where these two heuristics are not sufficient we add patterns with a `followup_value` autohelper macro.

Usually, the followup value gives only a small contribution; e.g. if it the followup value is very large, then GNU Go treats the move as sente by doubling its value. However, if the largest move on the board is a ko which we cannot legally take, then such a move becomes attractive as a ko threat and the full followup value is taken into account.

6.5 End Game

Endgame moves are generated just like any other move by GNU Go. In fact, the concept of endgame does not exist explicitly, but if the largest move initially found is worth 6 points or less, an extra set of patterns in `'endgame.db'` is matched and the move valuation is redone.

7 Worms and Dragons

Before considering its move, GNU Go collects some data in several arrays. Two of these arrays, called `worm` and `dragon`, are discussed in this document. Others are discussed in See [Chapter 8 \[Eyes\], page 60](#).

This information is intended to help evaluate the connectedness, eye shape, escape potential and life status of each group.

Later routines called by `genmove()` will then have access to this information. This document attempts to explain the philosophy and algorithms of this preliminary analysis, which is carried out by the two routines `make_worm()` and `make_dragon()` in `'dragon.c'`.

A *worm* is a maximal set of stones on the board which are connected along the horizontal and vertical lines, and are of the same color. We often say *string* instead of worm.

A *dragon* is a union of strings of the same color which will be treated as a unit. The dragons are generated anew at each move. If two strings are in the dragon, it is the computer's working hypothesis that they will live or die together and are effectively connected.

The purpose of the dragon code is to allow the computer to formulate meaningful statements about life and death. To give one example, consider the following situation:

```

00000
00XXX00
0X..X0
0XXXXX0
00000

```

The X's here should be considered a single group with one three-space eye, but they consist of two separate strings. Thus we must amalgamate these two strings into a single dragon. Then the assertion makes sense, that playing at the center will kill or save the dragon, and is a vital point for both players. It would be difficult to formulate this statement if the X's are not perceived as a unit.

The present implementation of the dragon code involves simplifying assumptions which can be refined in later implementations.

7.1 Worms

The array `struct worm_data worm[MAX_BOARD]` collects information about the worms. We will give definitions of the various fields. Each field has constant value at each vertex of the worm. We will define each field.

```

struct worm_data {
    int color;
    int size;
    float effective_size;
    int origin;
}

```

```

int liberties;
int liberties2;
int liberties3;
int liberties4;
int lunch;
int cutstone;
int cutstone2;
int genus;
int inessential;
int invincible;
int unconditional_status;
int attack_points[MAX_TACTICAL_POINTS];
int attack_codes[MAX_TACTICAL_POINTS];
int defense_points[MAX_TACTICAL_POINTS];
int defend_codes[MAX_TACTICAL_POINTS];
int attack_threat_points[MAX_TACTICAL_POINTS];
int attack_threat_codes[MAX_TACTICAL_POINTS];
int defense_threat_points[MAX_TACTICAL_POINTS];
int defense_threat_codes[MAX_TACTICAL_POINTS];
};

```

- **color**

The color of the worm.

- **size**

This field contains the cardinality of the worm.

- **effective_size**

This is the number of stones in a worm plus the number of empty intersections that are at least as close to this worm as to any other worm. Intersections that are shared are counted with equal fractional values for each worm. This measures the direct territorial value of capturing a worm. *effective_size* is a floating point number. Only intersections at a distance of 4 or less are counted.

- **origin**

Each worm has a distinguished member, called its *origin*. The purpose of this field is to make it easy to determine when two vertices lie in the same worm: we compare their origin. Also if we wish to perform some test once for each worm, we simply perform it at the origin and ignore the other vertices. The origin is characterized by the test:

```
worm[pos].origin == pos.
```

- **liberties**

- **liberties2**

- **liberties3**

- **liberties4**

For a nonempty worm the field *liberties* is the number of liberties of the string. This is supplemented by *LIBERTIES2*, *LIBERTIES3* and

LIBERTIES4, which are the number of second order, third order, and fourth order liberties, respectively. The definition of liberties of order >1 is adapted to the problem of detecting the shape of the surrounding empty space. In particular we want to be able to see if a group is loosely surrounded. A *liberty of order n* is an empty vertex which may be connected to the string by placing n stones of the same color on the board, but no fewer. The path of connection may pass through an intervening group of the same color. The stones placed at distance >1 may not touch a group of the opposite color. Connections through ko are not permitted. Thus in the following configuration:

.XX...	We label the	.XX.4.
XO...	liberties of	XO1234
XO...	order < 5 of	XO1234
.....	the 0 group:	.12.4.
.X.X..		.X.X..

The convention that liberties of order >1 may not touch a group of the opposite color means that knight's moves and one space jumps are perceived as impenetrable barriers. This is useful in determining when the string is becoming surrounded.

The path may also not pass through a liberty at distance 1 if that liberty is flanked by two stones of the opposing color. This reflects the fact that the O stone is blocked from expansion to the left by the two X stones in the following situation:

```

X.
.O
X.

```

We say that *n* is the *distance* of the liberty of order *n* from the dragon.

- **lunch**

If nonzero, **lunch** points to a boundary worm which can be easily captured. (It does not matter whether or not the string can be defended.)

We have two distinct notions of cutting stone, which we keep track of in the separate fields `worm.cutstone` and `worm.cutstone2`. We use currently use both concepts in parallel.

- **cutstone**

This field is equal to 2 for cutting stones, 1 for potential cutting stones. Otherwise it is zero. Definitions for this field: a *cutting stone* is one adjacent to two enemy strings, which do not have a liberty in common. The most common type of cutting string is in this situation:

```

XO
OX

```

A *potential cutting stone* is adjacent to two enemy strings which do share a liberty. For example, X in:

```
XO
O.
```

For cutting strings we set `worm[].cutstone=2`. For potential cutting strings we set `worm[].cutstone=1`.

- **cutstone2**

Cutting points are identified by the patterns in the connections database. Proper cuts are handled by the fact that attacking and defending moves also count as moves cutting or connecting the surrounding dragons. The `cutstone2` field is set during `find_cuts()`, called from `make_domains()`.

- **genus**

There are two separate notions of *genus* for worms and dragons. The dragon notion is more important, so `dragon[pos].genus` is a far more useful field than `worm[pos].genus`. Both fields are intended as approximations to the number of eyes. The *genus* of a string is the number of connected components of its complement, minus one. It is an approximation to the number of eyes of the string.

- **inessential**

An *inessential* string is one which meets a criterion designed to guarantee that it has no life potential unless a particular surrounding string of the opposite color can be killed. More precisely an *inessential string* is a string `S` of genus zero, not adjacent to any opponent string which can be easily captured, and which has no edge liberties or second order liberties, and which satisfies the following further property: If the string is removed from the board, then the remaining cavity only borders worms of the opposite color.

- **invincible**

An *invincible* worm is one which GNU Go thinks cannot be captured. Invincible worms are computed by the function `unconditional_life()` which tries to find those worms of the given color that can never be captured, even if the opponent is allowed an arbitrary number of consecutive moves.

- **unconditional_status**

Unconditional status is also set by the function `unconditional_life`. This is set `ALIVE` for stones which are invincible. Stones which can not be turned invincible even if the defender is allowed an arbitrary number of consecutive moves are given an unconditional status of `DEAD`. Empty points where the opponent cannot form an invincible worm are called unconditional territory. The unconditional status is set to `WHITE_TERRITORY` or `BLACK_TERRITORY` depending on who owns the territory. Finally, if a stone can be

captured but is adjacent to unconditional territory of its own color, it is also given the unconditional status `ALIVE`. In all other cases the unconditional status is `UNKNOWN`.

To make sense of these definitions it is important to notice that any stone which is alive in the ordinary sense (even if only in *seki*) can be transformed into an invincible group by some number of consecutive moves. Well, this is not entirely true because there is a rare class of *seki* groups not satisfying this condition. Exactly which these are is left as an exercise for the reader. Currently `unconditional_life`, which strictly follows the definitions above, calls such *seki* groups unconditionally dead, which of course is a misfeature. It is possible to avoid this problem by making the algorithm slightly more complex, but this is left for a later revision.

- `int attack_points[MAX_TACTICAL_POINTS]`
- `attack_codes[MAX_TACTICAL_POINTS]`
- `int defense_points[MAX_TACTICAL_POINTS];`
- `int defend_codes[MAX_TACTICAL_POINTS];`

If the tactical reading code (see [Chapter 11 \[Tactical Reading\], page 111](#)) finds that the worm can be attacked, `attack_points[0]` is a point of attack, and `attack_codes[0]` is the attack code, `WIN`, `KO_A` or `KO_B`. If multiple attacks are known, `attack_points[k]` and `attack_codes[k]` are used. Similarly with the defense codes and defense points.

- `int attack_threat_points[MAX_TACTICAL_POINTS];`
- `int attack_threat_codes[MAX_TACTICAL_POINTS];`
- `int defense_threat_points[MAX_TACTICAL_POINTS];`
- `int defense_threat_codes[MAX_TACTICAL_POINTS];`

These are points that threaten to attack or defend a worm.

The function `makeworms()` will generate data for all worms.

7.2 Amalgamation

A dragon, we have said, is a group of stones which are treated as a unit. It is a working hypothesis that these stones will live or die together. Thus the program will not expect to disconnect an opponent's strings if they have been amalgamated into a single dragon.

The function `make_dragons()` will amalgamate worms into dragons by maintaining separate arrays `worm[]` and `dragon[]` containing similar data. Each dragon is a union of worms. Just as the data maintained in `worm[]` is constant on each worm, the data in `dragon[]` is constant on each dragon.

Amalgamation of worms in GNU Go proceeds as follows. First we amalgamate all boundary components of an eyeshape. Thus in the following example:

```
.0000.      The four X strings are amalgamated into a
00XX0.      single dragon because they are the boundary
OX..XO      components of a blackbordered cave. The
OX..XO      cave could contain an inessential string
```

```
00XX0.      with no effect on this amalgamation.
XXX...
```

The code for this type of amalgamation is in the routine `dragon_eye()`, discussed further in `EYES`.

Next, we amalgamate strings which seem uncuttable. We amalgamate dragons which either share two or more common liberties, or share one liberty into the which the opponent cannot play without being captured. (ignores ko rule).

```
  X.    X.X    XXXX.XXX    X.O
  .X    X.X    X.....X    X.X
                XXXXXX.X    OXX
```

A database of connection patterns may be found in `'patterns/conn.db'`.

7.3 Connection

The fields `black_eye.cut` and `white_eye.cut` are set where the opponent can cut, and this is done by the B (break) class patterns in `'conn.db'`. There are two important uses for this field, which can be accessed by the autohelper functions `xcut()` and `ocut()`. The first use is to stop amalgamation in positions like

```
..X..
00*00
X.O.X
..0..
```

where X can play at * to cut off either branch. What happens here is that first connection pattern CB1 finds the double cut and marks * as a cutting point. Later the C (connection) class patterns in `conn.db` are searched to find secure connections over which to amalgamate dragons. Normally a diagonal connection would be deemed secure and amalgamated by connection pattern CC101, but there is a constraint requiring that neither of the empty intersections is a cutting point.

A weakness with this scheme is that X can only cut one connection, not both, so we should be allowed to amalgamate over one of the connections. This is performed by connection pattern CC401, which with the help of `amalgamate_most_valuable_helper()` decides which connection to prefer.

The other use is to simplify making alternative connection patterns to the solid connection. Positions where the `diag_miai` helper thinks a connection is necessary are marked as cutting points by connection pattern 12. Thus we can write a connection pattern like CC6:

```
?xxx?      straight extension to connect
X00*?
0...?
```

```

:8,C,NULL

?xxx?
X00b?
0a..?

;xcut(a) && odefend_against(b,a)

```

where we verify that a move at `*` would stop the enemy from safely playing at the cutting point, thus defending against the cut.

7.4 Half Eyes and False Eyes

A *half eye* is a place where, if the defender plays first, an eye will materialize, but where if the attacker plays first, no eye will materialize. A *false eye* is a vertex which is surrounded by a dragon yet is not an eye. Here is a half eye:

```

XXXXX
00..X
0.0.X
00XXX

```

Here is a false eye:

```

XXXXX
X00.X
0.0.X
00XXX

```

The "topological" algorithm for determining half and false eyes is described elsewhere (see [Section 8.8 \[Eye Topology\]](#), page 67).

The half eye data is collected in the dragon array. Before this is done, however, an auxiliary array called `half_eye_data` is filled with information. The field `type` is 0, or else `HALF_EYE` or `FALSE_EYE` depending on which type is found; the fields `attack_point[]` point to up to 4 points to attack the half eye, and similarly `defense_point[]` gives points to defend the half eye.

```

struct half_eye_data half_eye[MAX_BOARD];

struct half_eye_data {
    float value;          /* Topological eye value */
    int type;            /* HALF_EYE or FALSE_EYE */
    int num_attacks;     /* Number of attacking points */
    int attack_point[4]; /* The moves to attack a topological halfeye */
    int num_defends;     /* Number of defending points */
    int defense_point[4]; /* The moves to defend a topological halfeye */
};

```

The array `struct half_eye_data half_eye[MAX_BOARD]` contains information about half and false eyes. If the type is `HALF_EYE` then up to four moves are recorded which can either attack or defend the eye. In rare cases the attack points could be different from the defense points.

7.5 Dragons

The array `struct dragon_data dragon[MAX_BOARD]` collects information about the dragons. We will give definitions of the various fields. Each field has constant value at each vertex of the dragon. (Fields will be discussed below.)

```

struct dragon_data {
    int color;          /* its color */
    int id;            /* the index into the dragon2 array */
    int origin;        /* the origin of the dragon. Two vertices
                        /* are in the same dragon iff they have
                        /* same origin.
    int size;          /* size of the dragon */
    float effective_size; /* stones and surrounding spaces */
    int crude_status;  /* (ALIVE, DEAD, UNKNOWN, CRITICAL)*/
    int status;        /* best trusted status */
};

extern struct dragon_data dragon[BOARDMAX];

```

Other fields attached to the dragon are contained in the `dragon_data2` struct array. (Fields will be discussed below.)

```

struct dragon_data2 {
    int origin;
    int adjacent[MAX_NEIGHBOR_DRAGONS];
    int neighbors;
    int hostile_neighbors;
    int moyo_size;
};

```

```

float moyo_territorial_value;
int safety;
float weakness;
float weakness_pre_owl;
int escape_route;
struct eyevalue genus;
int heye;
int lunch;
int surround_status;
int surround_size;
int semeais;
int semeai_margin_of_safety;
int semeai_defense_point;
int semeai_defense_certain;
int semeai_attack_point;
int semeai_attack_certain;
int owl_threat_status;
int owl_status;
int owl_attack_point;
int owl_attack_code;
int owl_attack_certain;
int owl_second_attack_point;
int owl_defense_point;
int owl_defense_code;
int owl_defense_certain;
int owl_second_defense_point;
int owl_attack_kworm;
int owl_defense_kworm;
};

extern struct dragon_data2 *dragon2;

```

The difference between the two arrays is that the `dragon` array is indexed by the board, and there is a copy of the dragon data at every stone in the dragon, while there is only one copy of the `dragon2` data. The dragons are numbered, and the `id` field of the dragon is a key into the `dragon2` array. Two macros `DRAGON` and `DRAGON2` are provided for gaining access to the two arrays.

```

#define DRAGON2(pos) dragon2[dragon[pos].id]
#define DRAGON(d) dragon[dragon2[d].origin]

```

Thus if you know the position `pos` of a stone in the dragon you can access the dragon array directly, for example accessing the origin with `dragon[pos].origin`. However if you need a field from the `dragon2` array, you can access it using the `DRAGON2` macro, for example you can access its neighbor dragons by

```

for (k = 0; k < DRAGON2(pos).neighbors; k++) {
    int d = DRAGON2(pos).adjacent[k];
    int apos = dragon2[d].origin;
}

```

```

    do_something(a_pos);
}

```

Similarly if you know the dragon number (which is `dragon[pos].id`) then you can access the `dragon2` array directly, or you can access the `dragon` array using the `DRAGON` macro.

Here are the definitions of each field in the `dragon` array.

- `color`
The color of the dragon.
- `id`
The dragon number, used as a key into the `dragon2` array.
- `origin`
The origin of the dragon is a unique particular vertex of the dragon, useful for determining when two vertices belong to the same dragon. Before amalgamation the worm origins are copied to the dragon origins. Amalgamation of two dragons amounts to changing the origin of one.
- `size`
The number of stones in the dragon.
- `effective size`
The sum of the effective sizes of the constituent worms. Remembering that vertices equidistant between two or more worms are counted fractionally in `worm.effective_size`, this equals the cardinality of the dragon plus the number of empty vertices which are nearer this dragon than any other.
- `crude_status`
(ALIVE, DEAD, UNKNOWN, CRITICAL). An early measure of the life potential of the dragon. It is computed before the owl code is run and is superseded by the status as soon as that becomes available.
- `status`
The dragon status is the best measure of the dragon's health. It is computed after the owl code is run, then revised again when the `semai` code is run.

Here are definitions of the fields in the `dragon2` array.

- `origin`
The origin field is duplicated here.
- `adjacent`
- `adjacent [MAX_NEIGHBOR_DRAGONS]`
Dragons of either color near the given one are called *neighbors*. They are computed by the function `find_neighbor_dragons()`. The `dragon2.adjacent` array gives the dragon numbers of these dragons.
- `neighbors`
Dragons of either color near the given one are called *neighbors*. They are computed by the function `find_neighbor_dragons()`. The `dragon2.adjacent` array gives the dragon numbers of these dragons.

- neighbors
 - The number of neighbor dragons.
- hostile_neighbors
 - The number of neighbor dragons of the opposite color.
- moyo_size
- float moyo_territorial_value
 - The function `compute_surrounding_moyo_sizes()` assigns a size and a territorial value to the moyo around each dragon (see [Section 13.2 \[Territory and Moyo\]](#), page 129). This is the moyo size. They are recorded in these fields.
- safety
 - The dragon safety can take on one of the values
 - TACTICALLY_DEAD - a dragon consisting of a single worm found dead by the reading code (very reliable)
 - ALIVE - found alive by the owl or semeai code
 - STRONGLY_ALIVE - alive without much question
 - INVINCIBLE - definitively alive even after many tenukis
 - ALIVE_IN_SEKI - determined to be seki by the semeai code
 - CRITICAL - lives or dies depending on who moves first
 - DEAD - found to be dead by the owl code
 - INESSENTIAL - the dragon is unimportant (e.g. nakade stones) and dead
- weakness
- weakness_pre_owl
 - A floating point measure of the safety of a dragon. The dragon weakness is a number between 0. and 1., higher numbers for dragons in greater need of safety. The field `weakness_pre_owl` is a preliminary computation before the owl code is run.
- escape_route
 - A measure of the dragon's potential to escape towards safety, in case it cannot make two eyes locally. Documentation may be found in [Section 13.9 \[Escape\]](#), page 136.
- struct eyevalue genus
 - The approximate number of eyes the dragon can be expected to get. Not guaranteed to be accurate. The `eyevalue` struct, which is used throughout the engine, is declared thus:

```
struct eyevalue {
    unsigned char a; /* # of eyes if attacker plays twice */
    unsigned char b; /* # of eyes if attacker plays first */
    unsigned char c; /* # of eyes if defender plays first */
    unsigned char d; /* # of eyes if defender plays twice */
}
```

```
};
```

- `heyeye`
Location of a half eye attached to the dragon.
- `lunch`
If nonzero, this is the location of a boundary string which can be captured. In contrast with worm lunches, a dragon lunch must be able to defend itself.
- `surround_status`
- `surround_size`
In estimating the safety of a dragon it is useful to know if it is *surrounded*. See [Section 13.11 \[Surrounded Dragons\], page 140](#) and the comments in `'surround.c'` for more information about the algorithm. Used in computing the `escape_route`, and also callable from patterns (currently used by CB258).
- `semeais`
- `semeai_defense_point`
- `semeai_defense_certain`
- `semeai_attack_point`
- `semeai_attack_certain`
If two dragons of opposite color both have the status `CRITICAL` or `DEAD` they are in a *semeai* (capturing race), and their status must be adjudicated by the function `owl_analyze_semeai()` in `'owl.c'`, which attempts to determine which is alive, which dead, or if the result is *seki*, and whether it is important who moves first. The function `'new_semeai()'` in `'semeai.c'` attempts to revise the statuses and to generate move reasons based on these results. The field `dragon2.semeais` is nonzero if the dragon is an element of a *semeai*, and equals the number of *semeais* (seldom more than one). The *semeai* defense and attack points are locations the defender or attacker must move to win the *semeai*. The field `semeai_margin_of_safety` is intended to indicate whether the *semeai* is close or not but currently this field is not maintained. The fields `semeai_defense_certain` and `semeai_attack_certain` indicate that the *semeai* code was able to finish analysis without running out of nodes.
- `owl_status`
This is a classification similar to `dragon.crude_status`, but based on the life and death reading in `'owl.c'`. The owl code (see [Section 12.1 \[The Owl Code\], page 126](#)) is skipped for dragons which appear safe by certain heuristics. If the owl code is not run, the owl status is `UNCHECKED`. If `owl_attack()` determines that the dragon cannot be attacked, it is classified as `ALIVE`. Otherwise, `owl_defend()` is run, and if it can be defended it is classified as `CRITICAL`, and if not, as `DEAD`.
- `owl_attack_point`
If the dragon can be attacked this is the point to attack the dragon.

- owl_attack_code
The owl attack code, It can be WIN, KO_A, KO_B or 0 (see [\[Return Codes\]](#), page 111).
- owl_attack_certain
The owl reading is able to finish analyzing the attack without running out of nodes.
- owl_second_attack_point
A second attack point.
- owl_defense_point
If the dragon can be defended, this is the place to play.
- owl_defense_code
The owl defense code, It can be WIN, KO_A, KO_B or 0 (see [\[Return Codes\]](#), page 111).
- owl_defense_certain
The owl code is able to finish analyzing the defense without running out of nodes.
- owl_second_defense_point
A second owl defense point.

7.6 Colored Dragon Display

You can get a colored ASCII display of the board in which each dragon is assigned a different letter; and the different values of `dragon.status` values (`ALIVE`, `DEAD`, `UNKNOWN`, `CRITICAL`) have different colors. This is very handy for debugging. A second diagram shows the values of `owl.status`. If this is `UNCHECKED` the dragon is displayed in White.

Save a game in `sgf` format using `CGoban`, or using the `'-o'` option with `GNU Go` itself.

Open an `xterm` or `rxvt` window. You may also use the Linux console. Using the console, you may need to use “SHIFT-PAGE UP” to see the first diagram. `Xterm` will only work if it is compiled with color support—if you do not see the colors try `rxvt`. Make the background color black and the foreground color white.

Execute:

```
gnugo -l [filename] -L [movenum] -T to get the colored display.
```

The color scheme: Green = `ALIVE`; Yellow = `UNKNOWN`; Cyan = `DEAD` and Red = `CRITICAL`. Worms which have been amalgamated into the same dragon are labelled with the same letter.

Other useful colored displays may be obtained by using instead:

- the option `-E` to display eye spaces (see [Chapter 8 \[Eyes\]](#), page 60).
- the option `-m 0x0180` to display territory, moyo and area (see [Section 13.2 \[Territory and Moyo\]](#), page 129).

The colored displays are documented elsewhere (see [Section 5.8 \[Colored Display\]](#), page 38).

8 Eyes and Half Eyes

The purpose of this Chapter is to describe the algorithm used in GNU Go to determine eyes.

8.1 Local games

The fundamental paradigm of combinatorial game theory is that games can be added and in fact form a group. If ‘G’ and ‘H’ are games, then ‘G+H’ is a game in which each player on his turn has the option of playing in either move. We say that the game ‘G+H’ is the sum of the local games ‘G’ and ‘H’.

Each connected eyespace of a dragon affords a local game which yields a local game tree. The score of this local game is the number of eyes it yields. Usually if the players take turns and make optimal moves, the end scores will differ by 0 or 1. In this case, the local game may be represented by a single number, which is an integer or half integer. Thus if ‘n(O)’ is the score if ‘O’ moves first, both players alternate (no passes) and make alternate moves, and similarly ‘n(X)’, the game can be represented by ‘{n(O) | n(X)}’. Thus {1|1} is an eye, {2|1} is an eye plus a half eye, etc.

The exceptional game {2|0} can occur, though rarely. We call an eyespace yielding this local game a CHIMERA. The dragon is alive if any of the local games ends up with a score of 2 or more, so {2|1} is not different from {3|1}. Thus {3|1} is NOT a chimera.

Here is an example of a chimera:

```
XXXXX
XOOOX
XO.OOX
XX..OX
XXOOXX
XXXXX
```

8.2 Eye spaces

In order that each eyespace be assignable to a dragon, it is necessary that all the dragons surrounding it be amalgamated (see [Section 7.2 \[Amalgamation\], page 51](#)). This is the function of `dragon_eye()`.

An EYE SPACE for a black dragon is a collection of vertices adjacent to a dragon which may not yet be completely closed off, but which can potentially become eyespace. If an open eye space is sufficiently large, it will yield two eyes. Vertices at the edge of the eye space (adjacent to empty vertices outside the eye space) are called MARGINAL.

Here is an example from a game:

```

|. X . X X . . X O X O
|X . . . . . X X O O O
|O X X X X . . X O O O
|O O O O X . O X O O O
|. . . . O O O O X X O
|X O . X X X . . X O O
|X O O O O O O O X X O
|. X X O . O X O . . X
|X . . X . X X X X X X
|O X X O X . X O O X O

```

Here the ‘O’ dragon which is surrounded in the center has open eye space. In the middle of this open eye space are three dead ‘X’ stones. This space is large enough that O cannot be killed. We can abstract the properties of this eye shape as follows. Marking certain vertices as follows:

```

|- X - X X - - X O X O
|X - - - - - X X O O O
|O X X X X - - X O O O
|O O O O X - O X O O O
|! . . . O O O O X X O
|X O . X X X . ! X O O
|X O O O O O O O X X O
|- X X O - O X O - - X
|X - - X - X X X X X X
|O X X O X - X O O X O

```

the shape in question has the form:

```

!...
.XXX.!

```

The marginal vertices are marked with an exclamation point (!). The captured ‘X’ stones inside the eyespace are naturally marked ‘X’.

The precise algorithm by which the eye spaces are determined is somewhat complex. Documentation of this algorithm is in the comments in the source to the function `make_domains()` in ‘optics.c’.

The eyespaces can be conveniently displayed using a colored ascii diagram by running `gnugo -E`.

8.3 The eyespace as local game

In the abstraction, an eyespace consists of a set of vertices labelled:

! . X

Tables of many eyespaces are found in the database ‘patterns/eyes.db’. Each of these may be thought of as a local game. The result of this game is listed after the eyespace in the form :max,min, where max is the number of eyes the pattern yields if ‘O’ moves first, while min is the number of eyes the pattern yields if ‘X’ moves first. The player who owns the eye space is denoted ‘O’ throughout this discussion. Since three eyes are no better than two, there is no attempt to decide whether the space yields two eyes or three, so max never exceeds 2. Patterns with min>1 are omitted from the table.

For example, we have:

Pattern 548

```

x
xX.!
:0111

```

Here notation is as above, except that ‘x’ means ‘X’ or EMPTY. The result of the pattern is not different if ‘X’ has stones at these vertices or not.

We may abstract the local game as follows. The two players ‘O’ and ‘X’ take turns moving, or either may pass.

RULE 1: ‘O’ for his move may remove any vertex marked ‘!’ or marked ‘.’.

RULE 2: ‘X’ for his move may replace a ‘.’ by an ‘X’.

RULE 3: ‘X’ may remove a ‘!’. In this case, each ‘.’ adjacent to the ‘!’ which is removed becomes a ‘!’. If an ‘X’ adjoins the ‘!’ which is removed, then that ‘X’ and any which are connected to it are also removed. Any ‘.’ which are adjacent to the removed ‘X’s then become ‘.’.

Thus if ‘O’ moves first he can transform the eyeshape in the above example to:

```

...           or           !...
.XXX.!       .XXX.

```

However if ‘X’ moves he may remove the ‘!’ and the ‘.’s adjacent to the ‘!’ become ‘!’ themselves. Thus if ‘X’ moves first he may transform the eyeshape to:

```

!..           or           !..
.XXX.!       .XXX!

```

NOTE: A nuance which is that after the ‘X:1’, ‘O:2’ exchange below, ‘O’ is threatening to capture three X stones, hence has a half eye to the left of 2. This is subtle, and there are other such subtleties which our abstraction will not capture. Some of these at least can be dealt with by a refinements of the scheme, but we will content ourselves for the time being with a simplified model.

```

|- X - X X - - X O X O
|X - - - - - X X O O O
|O X X X X - - X O O O
|O O O O X - O X O O O
|1 2 . . 0 O O O X X O
|X O . X X X . 3 X O O
|X O O O O O O O X X O
|- X X O - O X O - - X
|X - - X - X X X X X X
|O X X O X - X O O X O

```

We will not attempt to characterize the terminal states of the local game (some of which could be *seki*) or the scoring.

8.4 An example

Here is a local game which yields exactly one eye, no matter who moves first:

```

!
...
...!

```

Here are some variations, assuming 'O' moves first.

```

!          (start position)
...
...!

```

```

...       (after 'O''s move)
...!

```

```

...
..!

```

```

...
..

```

```

.X.       (nakade)
..

```

Here is another variation:

```

!           (start)
...
...!

!           (after 'O''s move)
. .
...!

!           (after 'X''s move)
. .
..X!

. .
..X!

. !
.!
```

8.5 Graphs

It is a useful observation that the local game associated with an eyespace depends only on the underlying graph, which as a set consists of the set of vertices, in which two elements are connected by an edge if and only if they are adjacent on the Go board. For example the two eye shapes:

```

..
..

and

....
```

though distinct in shape have isomorphic graphs, and consequently they are isomorphic as local games. This reduces the number of eyespaces in the database `'patterns/eyes.db'`.

A further simplification is obtained through our treatment of half eyes and false eyes. Such patterns are identified by the topological analysis (see [Section 8.8 \[Eye Topology\]](#), [page 67](#)).

A half eye is isomorphic to the pattern `(!.).`. To see this, consider the following two eye shapes:

```

X000000
X.....0
X000000
```

and:

```
XX00000
X0a...0
Xb00000
XXXXXXX
```

These are equivalent eyeshapes, with isomorphic local games $\{2|1\}$. The first has shape:

```
!....
```

The second eyeshape has a half eye at ‘a’ which is taken when ‘0’ or ‘X’ plays at ‘b’. This is found by the topological criterion (see [Section 8.8 \[Eye Topology\], page 67](#)).

The graph of the eye_shape, ostensibly ‘. . . .’ is modified by replacing the left ‘.’ by ‘!.’ during graph matching.

A false eye is isomorphic to the pattern (!) . To see this, consider the following eye shape:

```
XXX000000
X.0a....0
XXX000000
```

This is equivalent to the two previous eyeshapes, with an isomorphic local game $\{2|1\}$.

This eyeshape has a false eye at ‘a’. This is also found by the topological criterion.

The graph of the eye_shape, ostensibly ‘.’ is modified by replacing the left ‘.’ by ‘!’ . This is made directly in the eye data, not only during graph matching.

8.6 Eye shape analysis

The patterns in ‘patterns/eyes.db’ are compiled into graphs represented essentially by arrays in ‘patterns/eyes.c’.

Each actual eye space as it occurs on the board is also compiled into a graph. Half eyes are handled as follows. Referring to the example

```
XX00000
X0a...0
Xb00000
XXXXXX
```

repeated from the preceding discussion, the vertex at ‘b’ is added to the eyespace as a marginal vertex. The adjacency condition in the graph is a macro (in ‘optics.c’): two vertices are adjacent if they are physically adjacent, or if one is a half eye and the other is its key point.

In `recognize_eyes()`, each such graph arising from an actual eyespace is matched against the graphs in `'eyes.c'`. If a match is found, the result of the local game is known. If a graph cannot be matched, its local game is assumed to be $\{2|2\}$.

8.7 Eye Local Game Values

The game values in `'eyes.db'` are given in a simplified scheme which is flexible enough to represent most possibilities in a useful way.

The colon line below the pattern gives the eye value of the matched eye shape. This consists of four digits, each of which is the number of eyes obtained during the following conditions:

1. The attacker moves first and is allowed yet another move because the defender plays tenuki.
2. The attacker moves first and the defender responds locally.
3. The defender moves first and the attacker responds locally.
4. The defender moves first and is allowed yet another move because the attacker plays tenuki.

The first case does **not** necessarily mean that the attacker is allowed two consecutive moves. This is explained with an example later.

Also, since two eyes suffice to live, all higher numbers also count as two.

The following 15 cases are of interest:

- 0000 0 eyes.
- 0001 0 eyes, but the defender can threaten to make one eye.
- 0002 0 eyes, but the defender can threaten to make two eyes.
- 0011 $1/2$ eye, 1 eye if defender moves first, 0 eyes if attacker does.
- 0012 $3/4$ eyes, $3/2$ eyes if defender moves first, 0 eyes if attacker does.
- 0022 1^* eye, 2 eyes if defender moves first, 0 eyes if attacker does.
- 0111 1 eye, attacker can threaten to destroy the eye.
- 0112 1 eye, attacker can threaten to destroy the eye, defender can threaten to make another eye.
- 0122 $5/4$ eyes, 2 eyes if defender moves first, $1/2$ eye if attacker does.
- 0222 2 eyes, attacker can threaten to destroy both.
- 1111 1 eye.
- 1112 1 eye, defender can threaten to make another eye.
- 1122 $3/2$ eyes, 2 eyes if defender moves first, 1 eye if attacker does.
- 1222 2 eyes, attacker can threaten to destroy one eye.
- 2222 2 eyes.

The $3/4$, $5/4$, and 1^* eye values are the same as in Howard Landman's paper *Eyespace Values in Go*. Attack and defense points are only marked in the patterns when they have definite effects on the eye value, i.e. pure threats are not marked.

Examples of all different cases can be found among the patterns in this file. Some of them might be slightly counterintuitive, so we explain one important case here. Consider

Pattern 6141

```
X
XX.@x
```

```
:1122
```

which e.g. matches in this position:

```
.000XXX
00X0X00
0XXba.0
0000000
```

Now it may look like 'X' could take away both eyes by playing 'a' followed by 'b', giving 0122 as eye value. This is where the subtlety of the definition of the first digit in the eye value comes into play. It does not say that the attacker is allowed two consecutive moves but only that he is allowed to play "another move". The crucial property of this shape is that when 'X' plays at a to destroy (at least) one eye, 'O' can answer at 'b', giving:

```
.000XXX
00.0X00
0.c0X.0
0000000
```

Now 'X' has to continue at 'c' in order to keep 'O' at one eye. After this 'O' plays tenuki and 'X' cannot destroy the remaining eye by another move. Thus the eye value is indeed 1122.

As a final note, some of the eye values indicating a threat depend on suicide to be allowed, e.g.

Pattern 301

```
X.X
```

```
:1222
```

We always assume suicide to be allowed in this database. It is easy enough to sort out such moves at a higher level when suicide is disallowed.

8.8 Topology of Half Eyes and False Eyes

A HALF EYE is a pattern where an eye may or may not materialize, depending on who moves first. Here is a half eye for O:

```
00XX
0.0.
00.X
```

A FALSE EYE is an eye vertex which cannot become a proper eye. Here are two examples of false eyes for O:

```

OOX      OOX
O.O      O.OO
XOO      OOX

```

We describe now the topological algorithm used to find half eyes and false eyes. In this section we ignore the possibility of ko.

False eyes and half eyes can locally be characterized by the status of the diagonal intersections from an eye space. For each diagonal intersection, which is not within the eye space, there are three distinct possibilities:

- occupied by an enemy (X) stone, which cannot be captured.
- either empty and X can safely play there, or occupied by an X stone that can both be attacked and defended.
- occupied by an O stone, an X stone that can be attacked but not defended, or it's empty and X cannot safely play there.

We give the first possibility a value of two, the second a value of one, and the last a value of zero. Summing the values for the diagonal intersections, we have the following criteria:

- sum \geq 4: false eye
- sum == 3: half eye
- sum \leq 2: proper eye

If the eye space is on the edge, the numbers above should be decreased by 2. An alternative approach is to award diagonal points which are outside the board a value of 1. To obtain an exact equivalence we must however give value 0 to the points diagonally off the corners, i.e. the points with both coordinates out of bounds.

The algorithm to find all topologically false eyes and half eyes is:

For all eye space points with at most one neighbor in the eye space, evaluate the status of the diagonal intersections according to the criteria above and classify the point from the sum of the values.

8.9 Eye Topology with Ko

This section extends the topological eye analysis to handle ko. We distinguish between a ko in favor of 'O' and one in favor of 'X':

```

.?O?    good for O
OO.O
O.O?
XOX.
.X..

```

```

.?0?   good for X
00.0
0X0?
X.X.
.X..

```

Preliminarily we give the former the symbolic diagonal value a and the latter the diagonal value b . We should clearly have $0 < a < 1 < b < 2$. Letting e be the topological eye value (still the sum of the four diagonal values), we want to have the following properties:

```

e <= 2    - proper eye
2 < e < 3 - worse than proper eye, better than half eye
e = 3     - half eye
3 < e < 4 - worse than half eye, better than false eye
e >= 4    - false eye

```

In order to determine the appropriate values of a and b we analyze the typical cases of ko contingent topological eyes:

```

(a)  .X..      (slightly) better than proper eye
     ..00      e < 2
     00.0
     0.00      e = 1 + a
     XOX.
     .X..

(a') .X..      better than half eye, worse than proper eye
     ..00      2 < e < 3
     00.0
     0X00      e = 1 + b
     X.X.
     .X..

(b)  .X..      better than half eye, worse than proper eye
     .X00      2 < e < 3
     00.0
     0.00      e = 2 + a
     XOX.
     .X..

(b') .X..      better than false eye, worse than half eye
     .X00      3 < e < 4
     00.0
     0X00      e = 2 + b
     X.X.
     .X..

```

	.X..	
	XOX.	(slightly) better than proper eye
(c)	0.00	$e < 2$
	00.0	
	0.00	$e = 2a$
	XOX.	
	.X..	
	.X..	
	XOX.	proper eye, some aji
(c')	0.00	$e \sim 2$
	00.0	
	0X00	$e = a + b$
	X.X.	
	.X..	
	.X..	
	X.X.	better than half eye, worse than proper eye
(c'')	0X00	$2 < e < 3$
	00.0	
	0X00	$e = 2b$
	X.X.	
	.X..	
	.X...	
	XOX..	better than half eye, worse than proper eye
(d)	0.0.X	$2 < e < 3$
	00.0.	
	0.00.	$e = 1 + 2a$
	XOX..	
	.X...	
	.X...	
	XOX..	half eye, some aji
(d')	0.0.X	$e \sim 3$
	00.0.	
	0X00.	$e = 1 + a + b$
	X.X..	
	.X...	

```

.X...
X.X..    better than false eye, worse than half eye
(d'') OX0.X    3 < e < 4
      00.0.
      OX00.    e = 1 + 2b
      X.X..
      .X...

```

```

.X...
XOX..    better than false eye, worse than half eye
(e)   0.0XX    3 < e < 4
      00.0.
      0.00.    e = 2 + 2a
      XOX..
      .X...

```

```

.X...
XOX..    false eye, some aji
(e')  0.0XX    e ~ 4
      00.0.
      OX00.    e = 2 + a + b
      X.X..
      .X...

```

```

.X...
X.X..    (slightly) worse than false eye
(e'') OX0XX    4 < e
      00.0.
      OX00.    e = 2 + 2b
      X.X..
      .X...

```

It may seem obvious that we should use

(i) $a=1/2$, $b=3/2$

but this turns out to have some drawbacks. These can be solved by using either of

(ii) $a=2/3$, $b=4/3$

(iii) $a=3/4$, $b=5/4$

(iv) $a=4/5$, $b=6/5$

Summarizing the analysis above we have the following table for the four different choices of a and b .

case	symbolic	$a=1/2$	$a=2/3$	$a=3/4$	$a=4/5$	desired
------	----------	---------	---------	---------	---------	---------

	value	b=3/2	b=4/3	b=5/4	b=6/5	interval
(a)	1+a	1.5	1.67	1.75	1.8	$e < 2$
(a')	1+b	2.5	2.33	2.25	2.2	$2 < e < 3$
(b)	2+a	2.5	2.67	2.75	2.8	$2 < e < 3$
(b')	2+b	3.5	3.33	3.25	3.2	$3 < e < 4$
(c)	2a	1	1.33	1.5	1.6	$e < 2$
(c')	a+b	2	2	2	2	$e \sim 2$
(c'')	2b	3	2.67	2.5	2.4	$2 < e < 3$
(d)	1+2a	2	2.33	2.5	2.6	$2 < e < 3$
(d')	1+a+b	3	3	3	3	$e \sim 3$
(d'')	1+2b	4	3.67	3.5	3.4	$3 < e < 4$
(e)	2+2a	3	3.33	3.5	3.6	$3 < e < 4$
(e')	2+a+b	4	4	4	4	$e \sim 4$
(e'')	2+2b	5	4.67	4.5	4.4	$4 < e$

We can notice that (i) fails for the cases (c''), (d), (d''), and (e). The other three choices get all values in the correct intervals. The main distinction between them is the relative ordering of (c'') and (d) (or analogously (d'') and (e)). If we do a more detailed analysis of these we can see that in both cases 'O' can secure the eye unconditionally if he moves first while 'X' can falsify it with ko if he moves first. The difference is that in (c''), 'X' has to make the first ko threat, while in (d), O has to make the first ko threat. Thus (c'') is better for O and ought to have a smaller topological eye value than (d). This gives an indication that (iv) is the better choice.

We can notice that any value of a , b satisfying $a+b=2$ and $3/4 < a < 1$ would have the same qualities as choice (iv) according to the analysis above. One interesting choice is $a=7/8$, $b=9/8$ since these allow exact computations with floating point values having a binary mantissa. The latter property is shared by $a=3/4$ and $a=1/2$.

When there are three kos around the same eyespace, things become more complex. This case is, however, rare enough that we ignore it.

8.10 False Margins

The following situation is rare but special enough to warrant separate attention:

```

0000XX
0XaX..
-----

```

Here 'a' may be characterized by the fact that it is adjacent to O's eyespace, and it is also adjacent to an X group which cannot be attacked, but that an X move at 'a' results in a string with only one liberty. We call this a *false margin*.

For the purpose of the eye code, O's eyespace should be parsed as (X), not (X!).

8.11 Functions in 'optics.c'

The public function `make_domains()` calls the function `make_primary_domains()` which is static in 'optics.c'. Its purpose is to compute the domains of influence of each color, used in determining eye shapes. **Note:** the term influence as used here is distinct from the influence in `influence.c`.

For this algorithm the strings which are not lively are invisible. Ignoring these, the algorithm assigns friendly influence to

1. every vertex which is occupied by a (lively) friendly stone,
2. every empty vertex adjoining a (lively) friendly stone,
3. every empty vertex for which two adjoining vertices (not on the first line) in the (usually 8) surrounding ones have friendly influence, with two CAVEATS explained below.

Thus in the following diagram, ‘e’ would be assigned friendly influence if ‘a’ and ‘b’ have friendly influence, or ‘a’ and ‘d’. It is not sufficient for ‘b’ and ‘d’ to have friendly influence, because they are not adjoining.

```

uabc
 def
  ghi

```

The constraint that the two adjoining vertices not lie on the first line prevents influence from leaking under a stone on the third line.

The first CAVEAT alluded to above is that even if ‘a’ and ‘b’ have friendly influence, this does not cause ‘e’ to have friendly influence if there is a lively opponent stone at ‘d’. This constraint prevents influence from leaking past knight’s move extensions.

The second CAVEAT is that even if ‘a’ and ‘b’ have friendly influence this does not cause ‘e’ to have influence if there are lively opponent stones at ‘u’ and at ‘c’. This prevents influence from leaking past nikken tobis (two space jumps).

The corner vertices are handled slightly different.

```

+---
|ab
|cd

```

We get friendly influence at ‘a’ if we have friendly influence at ‘b’ or ‘c’ and no lively unfriendly stone at ‘b’, ‘c’ or ‘d’.

Here are the public functions in ‘optics.c’, except some simple access functions used by autohelpers. The statically declared functions are documented in the source code.

- `void make_domains(struct eye_data b_eye[BOARDMAX], struct eye_data w_eye[BOARDMAX], int owl_call)`
This function is called from `make_dragons()` and from `owl_determine_life()`. It marks the black and white domains (eyeshape regions) and collects some statistics about each one.
- `void partition_eyespace(struct eye_data eye[BOARDMAX], int color)`
Find connected eyespace components and compute relevant statistics.
- `void propagate_eye(int origin, struct eye_data eye[BOARDMAX])`
`propagate_eye(origin)` copies the data at the (origin) to the rest of the eye (invariant fields only).
- `int find_eye_dragons(int origin, struct eye_data eye[BOARDMAX], int eye_color, int dragons[], int max_dragons)`
Find the dragon or dragons surrounding an eye space. Up to `max_dragons` dragons adjacent to the eye space are added to the dragon array, and the number of dragons found is returned.

- `void compute_eyes(int pos, struct eyevalue *value, int *attack_point, int *defense_point, struct eye_data eye[BOARDMAX], struct half_eye_data heye[BOARDMAX], int add_moves)`

Given an eyespace with origin `pos`, this function computes the minimum and maximum numbers of eyes the space can yield. If `max` and `min` are different, then vital points of attack and defense are also generated. If `add_moves == 1`, this function may add a `move_reason` for `color` at a vital point which is found by the function. If `add_moves == 0`, set `color = EMPTY`.

- `void compute_eyes_pessimistic(int pos, struct eyevalue *value, int *pessimistic_min, int *attack_point, int *defense_point, struct eye_data eye[BOARDMAX], struct half_eye_data heye[BOARDMAX])`

This function works like `compute_eyes()`, except that it also gives a pessimistic view of the chances to make eyes. Since it is intended to be used from the owl code, the option to add move reasons has been removed.

- `void add_false_eye(int pos, struct eye_data eye[BOARDMAX], struct half_eye_data heye[BOARDMAX])`

turns a proper eyespace into a margin.

- `int is_eye_space(int pos)`
- `int is_proper_eye_space(int pos)`

These functions are used from constraints to identify eye spaces, primarily for late endgame moves.

- `int max_eye_value(int pos)`

Return the maximum number of eyes that can be obtained from the eyespace at `(i, j)`. This is most useful in order to determine whether the eyespace can be assumed to produce any territory at all.

- `int is_marginal_eye_space(int pos)`
- `int is_halfeye(struct half_eye_data heye[BOARDMAX], int pos)`
- `int is_false_eye(struct half_eye_data heye[BOARDMAX], int pos)`

These functions simply return information about an eyeshape that has already been analyzed. (They do no real work.)

- `void find_half_and_false_eyes(int color, struct eye_data eye[BOARDMAX], struct half_eye_data heye[BOARDMAX], int find_mask[BOARDMAX])`

Find topological half eyes and false eyes by analyzing the diagonal intersections, as described in the Texinfo documentation (Eyes/Eye Topology).

- `float topological_eye(int pos, int color, struct eye_data my_eye[BOARDMAX], struct half_eye_data heye[BOARDMAX])`

See Texinfo documentation (Eyes:Eye Topology). Returns:

- 2 or less if `pos` is a proper eye for `color`;
- between 2 and 3 if the eye can be made false only by `ko`
- 3 if `pos` is a half eye;
- between 3 and 4 if the eye can be made real only by `ko`
- 4 or more if `pos` is a false eye.

Attack and defense points for control of the diagonals are stored in the `heye[]` array. `my_eye` is the eye space information with respect to color.

- `int obvious_false_eye(int pos, int color)`
 Conservative relative of `topological_eye()`. Essentially the same algorithm is used, but only tactically safe opponent strings on diagonals are considered. This may underestimate the false/half eye status, but it should never be overestimated.
- `void set_eyevalue(struct eyevalue *e, int a, int b, int c, int d)`
set parameters into the struct eyevalue as follows: (see [Section 8.7 \[Eye Local Game Values\]](#), page 66):

```

        struct eyevalue { /* number of eyes if: */
            unsigned char a; /* attacker plays first twice */
            unsigned char b; /* attacker plays first */
            unsigned char c; /* defender plays first */
            unsigned char d; /* defender plays first twice */
        };
    
```
- `int min_eye_threat(struct eyevalue *e)`
 Number of eyes if attacker plays first twice (the threat of the first move by attacker).
- `int min_eyes(struct eyevalue *e)`
 Number of eyes if attacker plays first followed by alternating play.
- `int max_eyes(struct eyevalue *e)`
 Number of eyes if defender plays first followed by alternating play.
- `int max_eye_threat(struct eyevalue *e)`
 Number of eyes if defender plays first twice (the threat of the first move by defender).
- `void add_eyevales(struct eyevalue *e1, struct eyevalue *e2, struct eyevalue *sum)`
 Add the eyevalues `*e1` and `*e2`, leaving the result in `*sum`. It is safe to let `sum` be the same as `e1` or `e2`.
- `char * eyevalue_to_string(struct eyevalue *e)`
 Produces a string containing the eyevalue. **Note:** the result string is stored in a statically allocated buffer which will be overwritten the next time this function is called.
- `void test_eyeshape(int eyesize, int *eye_vertices) /* Test whether the optics code evaluates an eyeshape consistently. */`
- `int analyze_eyegraph(const char *coded_eyegraph, struct eyevalue *value, char *analyzed_eyegraph)`
 Analyze an eye graph to determine the eye value and vital moves. The eye graph is given by a string which is encoded with ‘%’ for newlines and ‘0’ for spaces. E.g., the eye graph

```

        !
    
```

```
.X  
!...
```

is encoded as `00!%0.X%!...` (The encoding is needed for the GTP interface to this function.) The result is an eye value and a (nonencoded) pattern showing the vital moves, using the same notation as `eyes.db`. In the example above we would get the eye value 0112 and the graph (showing ko threat moves)

```
.X  
!.*.
```

If the eye graph cannot be realized, 0 is returned, 1 otherwise.

9 The Pattern Code

9.1 Overview

Several pattern databases are in the patterns directory. This chapter primarily discusses the patterns in ‘patterns.db’, ‘patterns2.db’, and the pattern files ‘hoshi.db’ etc. which are compiled from the SGF files ‘hoshi.sgf’ (see [Section 9.16 \[Joseki Compiler\]](#), page 98). There is no essential difference between these files, except that the ones in ‘patterns.db’ and ‘patterns2.db’ are hand written. They are concatenated before being compiled by `mkpat` into ‘patterns.c’. The purpose of the separate file ‘patterns2.db’ is that it is handy to move patterns into a new directory in the course of organizing them. The patterns in ‘patterns.db’ are more disorganized, and are slowly being moved to ‘patterns2.db’.

During the execution of `genmove()`, the patterns are matched in ‘shapes.c’ in order to find move reasons.

The same basic pattern format is used by ‘attack.db’, ‘defense.db’, ‘conn.db’, ‘apats.db’ and ‘dpats.db’. However these patterns are used for different purposes. These databases are discussed in other parts of this documentation. The patterns in ‘eyes.db’ are entirely different and are documented elsewhere (see [Chapter 8 \[Eyes\]](#), page 60).

The patterns described in the databases are ascii representations, of the form:

Pattern EB112

```
?X?.?      jump under
O.*oo
O....
o....
-----
```

```
:8,ed,NULL
```

Here ‘O’ marks a friendly stone, ‘X’ marks an enemy stone, ‘.’ marks an empty vertex, ‘*’ marks O’s next move, ‘o’ marks a square either containing ‘O’ or empty but not ‘X’. (The symbol ‘x’, which does not appear in this pattern, means ‘X’ or ‘.’.) Finally ‘?’ Indicates a location where we don’t care what is there, except that it cannot be off the edge of the board.

The line of ‘-’s along the bottom in this example is the edge of the board itself—this is an edge pattern. Corners can also be indicated. Elements are not generated for ‘?’ markers, but they are not completely ignored - see below.

The line beginning ‘:’ describes various attributes of the pattern, such as its symmetry and its class. Optionally, a function called a “helper” can be provided to assist the matcher in deciding whether to accept move. Most patterns do not require a helper, and this field is filled with NULL.

The matcher in ‘matchpat.c’ searches the board for places where this layout appears on the board, and the callback function `shapes_callback()` in ‘shapes.c’ registers the appropriate move reasons.

After the pattern, there is some supplementary information in the format:

```
:trfno, classification, [values], helper_function
```

Here `trfno` represents the number of transformations of the pattern to consider, usually ‘8’ (no symmetry, for historical reasons), or one of ‘|’, ‘\’, ‘/’, ‘-’, ‘+’, ‘X’, where the line represents the axis of symmetry. (E.g. ‘|’ means symmetrical about a vertical axis.)

The above pattern could equally well be written on the left edge:

```
|o00?
|...X
|..*?
|..o.
|..o?
```

```
:8,ed,NULL
```

The program `mkpat` is capable of parsing patterns written this way, or for that matter, on the top or right edges, or in any of the four corners. As a matter of convention all the edge patterns in ‘`patterns.db`’ are written on the bottom edge or in the lower left corners. In the ‘`patterns/`’ directory there is a program called `transpat` which can rotate or otherwise transpose patterns. This program is not built by default—if you think you need it, make `transpat` in the ‘`patterns/`’ directory and consult the usage remarks at the beginning of ‘`patterns/transpat.c`’.

9.2 Pattern Attributes

The attribute field in the ‘:’ line of a pattern consists of a sequence of zero or more of the following characters, each with a different meaning. The attributes may be roughly classified as *constraints*, which determine whether or not the pattern is matched, and *actions*, which describe what is to be done when the pattern is matched, typically to add a move reason.

9.2.1 Constraint Pattern Attributes

- ‘s’

Safety of the move is not checked. This is appropriate for sacrifice patterns. If this classification is omitted, the matcher requires that the stone played cannot be trivially captured. Even with s classification, a check for legality is made, though.

- ‘n’

In addition to usual check that the stone played cannot be trivially captured, it is also confirmed that an opponent move here could not be captured.

- ‘0’

It is checked that every friendly (‘0’) stone of the pattern belongs to a dragon which has status (see [Section 7.5 \[Dragons\], page 54](#)) `ALIVE` or `UNKNOWN`. The `CRITICAL` matcher status is excluded. It is possible for a string to have `ALIVE` status and still be tactically critical, since it might be

amalgamated into an ALIVE dragon, and the matcher status is constant on the dragon. Therefore, an additional test is performed: if the pattern contains a string which is tactically critical, and if '*' does not rescue it, the pattern is rejected.

- 'o'

It is checked that every friendly ('O') stone of the pattern belongs to a dragon which is classified as DEAD or UNKNOWN.

- 'X'

It is checked that every opponent ('X') stone of the pattern belongs to a dragon with status ALIVE, UNKNOWN or CRITICAL. Note that there is an asymmetry with 'O' patterns, where CRITICAL dragons are rejected.

- 'x'

It is checked that every opponent ('X') stone of the pattern belongs to a dragon which is classified as DEAD or UNKNOWN

9.2.2 Action Attributes

- 'C'

If two or more distinct O dragons occur in the pattern, the move is given the move reasons that it connects each pair of dragons. An exception is made for dragons where the underlying worm can be tactically captured and is not defended by the considered move.

- 'c'

Add strategical defense move reason for all our dragons and a small shape bonus. This classification is appropriate for weak connection patterns.

- 'B'

If two or more distinct 'X' dragons occur in the pattern, the move is given the move reasons that it cuts each pair of dragons.

- 'e'

The move makes or secures territory.

- 'E'

The move attempts increase influence and create/expand a moyo.

- 'd'

The move strategically defends all O dragons in the pattern, except those that can be tactically captured and are not tactically defended by this move. If any O dragon should happen to be perfectly safe already, this only reflects in the move reason being valued to zero.

- 'a'

The move strategically attacks all 'X' dragons in the pattern.

- 'J'

Standard joseki move. Unless there is an urgent move on the board these moves are made as soon as they can be. This is equivalent to adding the 'd' and 'a' classifications together with a minimum accepted value of 27.

- ‘F’
This indicates a fuseki pattern. This is only effective together with either the ‘j’ or ‘t’ classification, and is used to ensure indeterministic play during fuseki.
- ‘j’
Slightly less urgent joseki move. These moves will be made after those with the ‘J’ classification. This adds the ‘e’ and ‘E’ classifications. If the move has the ‘F’ classification, it also gets a fixed value of 20.1, otherwise it gets a minimum accepted value of 20. (This makes sure that GNU Go chooses randomly between different moves that have ‘jF’ as classification.)
- ‘t’
Minor joseki move (tenuki OK). This is equivalent to adding the ‘e’ and ‘E’ classifications together with either a fixed value of 15.07 (if the move has ‘F’ classification) or a minimum value of 15 (otherwise).
- ‘U’
Urgent joseki move (never tenuki). This is equivalent to the ‘d’ and ‘a’ classifications together with a shape bonus of 15 and a minimum accepted value of 40.

A commonly used class is `OX` (which rejects pattern if either side has dead stones). The string ‘-’ may be used as a placeholder. (In fact any characters other than the above and ‘,’ are ignored.)

The types ‘o’ and ‘O’ could conceivably appear in a class, meaning it applies only to UNKNOWN. ‘X’ and ‘x’ could similarly be used together. All classes can be combined arbitrarily.

9.3 Pattern Attributes

The second and following fields in the ‘:’ line of a pattern are optional and of the form `value1(x), value2(y), ...`. The available set of values are as follows.

- `terri(x)`
Forces the territorial value of the move to be at least x.
- `minterri(x)`
Forces the territorial value of the move to be at least x.
- `maxterri(x)`
Forces the territorial value of the move to be at most x.
- `value(x)`
Forces the final value of the move to be at least x.
- `minvalue(x), maxvalue(x)`
Forces the final value of the move to be at least/most x.
- `shape(x)`
Adds x to the move’s shape value.
- `followup(x)`
Adds x to the move’s followup value.

The meaning of these values is documented in See [Chapter 6 \[Move Generation\]](#), page 40.

9.4 Helper Functions

Helper functions can be provided to assist the matcher in deciding whether to accept a pattern, register move reasons, and setting various move values. The helper is supplied with the compiled pattern entry in the table, and the (absolute) position on the board of the '*' point.

One difficulty is that the helper must be able to cope with all the possible transformations of the pattern. To help with this, the `OFFSET` macro is used to transform relative pattern coordinates to absolute board locations.

The actual helper functions are in `'helpers.c'`. They are declared in `'patterns.h'`.

As an example to show how to write a helper function, we consider a hypothetical helper called `wedge_helper`. Such a helper used to exist, but has been replaced by a constraint. Due to its simplicity it's still a good example. The helper begins with a comment:

```
/*
?0.          ?0b
.X*          aX*
?0.          ?0c

:8,C,wedge_helper
*/
```

The image on the left is the actual pattern. On the right we've taken this image and added letters to label `apos`, `bpos`, and `cpos`. The position of *, the point where GNU Go will move if the pattern is adopted, is passed through the parameter `move`.

```
int
wedge_helper(ARGS)
{
    int apos, bpos, cpos;
    int other = OTHER_COLOR(color);
    int success = 0;

    apos = OFFSET(0, -2);
    bpos = OFFSET(-1, 0);
    cpos = OFFSET(1, 0);

    if (TRYMOVE(move, color)) {
        if (TRYMOVE(apos, other)) {
            if (board[apos] == EMPTY || attack(apos, NULL))
                success = 1;
            else if (TRYMOVE(bpos, color)) {
                if (!safe_move(cpos, other))
                    success = 1;
            }
            popgo();
        }
    }
}
```

```

        }
        popgo();
    }
    popgo();
}

return success;
}

```

The `OFFSET` lines tell GNU Go the positions of the three stones at ‘a’, ‘b’, and ‘c’. To decide whether the pattern guarantees a connection, we do some reading. First we use the `TRYMOVE` macro to place an ‘O’ at ‘move’ and let ‘X’ draw back to ‘a’. Then we ask whether ‘O’ can capture these stones by calling `attack()`. The test if there is a stone at ‘a’ before calling `attack()` is in this position not really necessary but it’s good practice to do so, because if the attacked stone should happen to already have been captured while placing stones, GNU Go would crash with an assertion failure.

If this attack fails we let ‘O’ connect at ‘b’ and use the `safe_move()` function to examine whether a cut by ‘X’ at ‘c’ could be immediately captured. Before we return the result we need to remove the stones we placed from the reading stack. This is done with the function `popgo()`.

9.5 Autohelpers and Constraints

In addition to the hand-written helper functions in ‘`helpers.c`’, GNU Go can automatically generate helper functions from a diagram with labels and an expression describing a constraint. The constraint diagram, specifying the labels, is placed below the ‘:’ line and the constraint expression is placed below the diagram on line starting with a ‘;’. Constraints can only be used to accept or reject a pattern. If the constraint evaluates to zero (false) the pattern is rejected, otherwise it’s accepted (still conditioned on passing all other tests of course). To give a simple example we consider a connection pattern.

```

Pattern Conn311

O*.
?XO

:8,C,NULL

O*a
?BO

;oplay_attack_either(*,a,a,B)

```

Here we have given the label ‘a’ to the empty spot to the right of the considered move and the label ‘B’ to the ‘X’ stone in the pattern. In addition to these, ‘*’ can also be used as a label. A label may be any lowercase or uppercase ascii letter except `OoXxt`. By

convention we use uppercase letters for ‘X’ stones and lowercase for ‘O’ stones and empty intersections. When labeling a stone that’s part of a larger string in the pattern, all stones of the string should be marked with the label. (These conventions are not enforced by the pattern compiler, but to make the database consistent and easy to read they should be followed.)

The labels can now be used in the constraint expression. In this example we have a reading constraint which should be interpreted as "Play an ‘O’ stone at ‘*’ followed by an ‘X’ stone at ‘a’. Accept the pattern if ‘O’ now can capture either at ‘a’ or at ‘B’ (or both strings)."

The functions that are available for use in the constraints are listed in the section ‘Autohelpers Functions’ below. Technically the constraint expression is transformed by `mkpat` into an automatically generated helper function in ‘`patterns.c`’. The functions in the constraint are replaced by C expressions, often functions calls. In principle any valid C code can be used in the constraints, but there is in practice no reason to use anything more than boolean and arithmetic operators in addition to the autohelper functions. Constraints can span multiple lines, which are then concatenated.

9.6 Autohelper Actions

As a complement to the constraints, which only can accept or reject a pattern, one can also specify an action to perform when the pattern has passed all tests and finally has been accepted.

Example:

```

Pattern EJ4

...*.      continuation
.OOX.
..XOX
.....
-----

:8,Ed,NULL

...*.      never play a here
.OOX.
.aXOX
.....
-----

>antisuji(a)

```

The line starting with ‘>’ is the action line. In this case it tells the move generation that the move at a should not be considered, whatever move reasons are found by other patterns. The action line uses the labels from the constraint diagram. Both constraint and

action can be used in the same pattern. If the action only needs to refer to ‘*’, no constraint diagram is required. Like constraints, actions can span multiple lines.

Here is a partial list of the autohelper macros which are typically called from action lines. This list is not complete. If you cannot find an autohelper macro in an action line in this list, consult ‘mkpat.c’ to find out what function in the engine is actually called. If no macro exists which does what you want, you can add macros by editing the list in ‘mkpat.c’.

- `antisuji(a);`
Mark ‘a’ as an antisuji, that is, a move that must never be played.
- `replace(a,*)`
This is appropriate if the move at ‘*’ is definitely better than the move at ‘a’. The macro adds a point redistribution rule. Any points which are assigned to ‘a’ during the move generation by any move reason are redistributed to ‘*’.
- `prevent_attack_threat(a)`
Add a reverse followup value because the opponent’s move here would threaten to capture ‘a’.
- `threaten_to_save(a)`
Add a followup value because the move at ‘*’ threatens to rescue the dead string at ‘a’.
- `defend_against_atari(a)`
Estimate the value of defending the string ‘a’ which can be put into atari and add this as a reverse followup value.
- `add_defend_both_move(a,b);`
- `add_cut_move(c,d);`
Add to the move reasons that the move at ‘*’ threatens to cut ‘c’ and ‘d’.

9.7 Autohelper Functions

The autohelper functions are translated into C code by the program in ‘mkpat.c’. To see exactly how the functions are implemented, consult the autohelper function definitions in that file. Autohelper functions can be used in both constraint and action lines.

```
lib(x)
lib2(x)
lib3(x)
lib4(x)
```

Number of first, second, third, and fourth order liberties of a worm respectively. See [Chapter 7 \[Worms and Dragons\], page 47](#), the documentation on worms for definitions.

```
xlib(x)
olib(x)
```

The number of liberties that an enemy or own stone, respectively, would obtain if played at the empty intersection ‘x’.

```
xcut(x)
ocut(x)
```

Calls `cut_possible` (see [Section 18.1 \[General Utilities\], page 167](#)) to determine whether ‘X’ or ‘O’ can cut at the empty intersection ‘x’.

```
ko(x)
```

True if ‘x’ is either a stone or an empty point involved in a ko position.

```
status(x)
```

The matcher status of a dragon. `status(x)` returns an integer that can have the values ALIVE, UNKNOWN, CRITICAL, or DEAD (see [Chapter 7 \[Worms and Dragons\], page 47](#)).

```
alive(x)
unknown(x)
critical(x)
dead(x)
```

Each function true if the dragon has the corresponding matcher status and false otherwise (see [Chapter 7 \[Worms and Dragons\], page 47](#)).

```
status(x)
```

Returns the status of the dragon at ‘x’ (see [Chapter 7 \[Worms and Dragons\], page 47](#)).

```
genus(x)
```

The number of eyes of a dragon. It is only meaningful to compare this value against 0, 1, or 2.

```
xarea(x)
oarea(x)
xmoyo(x)
omoyo(x)
xterri(x)
oterri(x)
```

These functions call `whose_territory()`, `whose_moyo()` and `whose_area()` (see [Section 13.2 \[Territory and Moyo\], page 129](#)). For example `xarea(x)` evaluates to true if ‘x’ is either a living enemy stone or an empty point within the opponent’s “area”. The function `oarea(x)` is analogous but with respect to our stones and area. The main difference between area, moyo, and terri is that area is a very far reaching kind of influence, moyo gives a more realistic estimate of what may turn in to territory, and terri gives the points that already are believed to be secure territory.

```
weak(x)
```

True for a dragon that is perceived as weak.

```
attack(x)
defend(x)
```

Results of tactical reading. `attack(x)` is true if the worm can be captured, `defend(x)` is true if there also is a defending move. Please notice that `defend(x)` will return false if there is no attack on the worm.

```
safe_xmove(x)
safe_omove(x)
```

True if an enemy or friendly stone, respectively, can safely be played at 'x'. By safe it is understood that the move is legal and that it cannot be captured right away.

```
legal_xmove(x)
legal_omove(x)
```

True if an enemy or friendly stone, respectively, can legally be played at x.

```
o_somewhere(x,y,z, ...)
x_somewhere(x,y,z, ...)
```

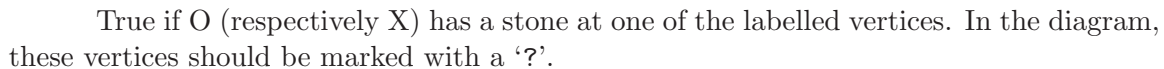
True if O (respectively X) has a stone at one of the labelled vertices. In the diagram, these vertices should be marked with a '?'.

```
odefend_against(x,y)
xdefend_against(x,y)
```

True if an own stone at 'x' would stop the enemy from safely playing at 'y', and conversely for the second function.

```
does_defend(x,y)
does_attack(x,y)
```

True if a move at 'x' defends/attacks the worm at 'y'. For defense a move of the same color as 'y' is tried and for attack a move of the opposite color.

```
xplay_defend(a,b,c,...,z)
oplay_defend(a,b,c,...,z)
xplay_attack(a,b,c,...,z)
oplay_attack(a,b,c,...,z)
```

These functions make it possible to do more complex reading experiments in the constraints. All of them work so that first the sequence of moves 'a','b','c',... is played through with alternating colors, starting with 'X' or 'O' as indicated by the name. Then it is tested whether the worm at 'z' can be attacked or defended, respectively. It doesn't matter who would be in turn to move, a worm of either color may be attacked or defended. For attacks the opposite color of the string being attacked starts moving and for defense

the same color starts. The defend functions return true if the worm cannot be attacked in the position or if it can be attacked but also defended. The attack functions return true if there is a way to capture the worm, whether or not it can also be defended. If there is no stone present at ‘z’ after the moves have been played, it is assumed that an attack has already been successful or a defense has already failed. If some of the moves should happen to be illegal, typically because it would have been suicide, the following moves are played as if nothing has happened and the attack or defense is tested as usual. It is assumed that this convention will give the relevant result without requiring a lot of special cases.

The special label ‘?’ can be used to represent a tenuki. Thus `oplay_defend(a,?,b,c)` tries moves by ‘O’ at ‘a’ and ‘b’, as if ‘X’ plays the second move in another part of the board, then asks if ‘c’ can be defended. The tenuki cannot be the first move of the sequence, nor does it need to be: instead of `oplay_defend(?,a,b,c)` you can use `xplay_defend(a,b,c)`.

```
xplay_defend_both(a,b,c,...,y,z)
oplay_defend_both(a,b,c,...,y,z)
xplay_attack_either(a,b,c,...,y,z)
oplay_attack_either(a,b,c,...,y,z)
```

These functions are similar to the previous ones. The difference is that the last *two* arguments denote worms to be attacked or defended simultaneously. Obviously ‘y’ and ‘z’ must have the same color. If either location is empty, it is assumed that an attack has been successful or a defense has failed. The typical use for these functions is in cutting patterns, where it usually suffices to capture either cutstone.

The function `xplay_defend_both` plays alternate moves beginning with an ‘X’ at ‘a’. Then it passes the last two arguments to `defend_both` in ‘engine/utils.c’. This function checks to determine whether the two strings can be simultaneously defended.

The function `xplay_attack_either` plays alternate moves beginning with an ‘X’ move at ‘a’. Then it passes the last two arguments to `attack_either` in ‘engine/utils.c’. This function looks for a move which captures at least one of the two strings. In its current implementation `attack_either` only looks for uncoordinated attacks and would thus miss a double atari.

```
xplay_connect(a,b,c,...,y,z)
oplay_connect(a,b,c,...,y,z)
xplay_disconnect(a,b,c,...,y,z)
oplay_disconnect(a,b,c,...,y,z)
```

The function `xplay_connect(a,b,c,...,y,z)` begins with an ‘X’ move at ‘a’, then an ‘O’ move at ‘b’, and so forth, then finally calls `string_connect()` to determine whether ‘x’ and ‘y’ can be connected. The other functions are similar (see [Section 11.10 \[Connection Reading\], page 125](#)).

```
xplay_break_through(a,b,c,...,x,y,z)
oplay_break_through(a,b,c,...,x,y,z)
```

These functions are used to set up a position like

```
.O.   .y.
OXO   xXz
```

and 'X' aims at capturing at least one of 'x', 'y', and 'z'. If this succeeds '1' is returned. If it doesn't, 'X' tries instead to cut through on either side and if this succeeds, '2' is returned. Of course the same shape with opposite colors can also be used.

Important notice: 'x', 'y', and 'z' must be given in the order they have in the diagram above, or any reflection and/or rotation of it.

`seki_helper(x)`

Checks whether the string at 'x' can attack any surrounding string. If so, return false as the move to create a seki (probably) wouldn't work.

`threaten_to_save(x)`

Calls `add_followup_value` to add as a move reason a conservative estimate of the value of saving the string 'x' by capturing one opponent stone.

`area_stone(x)`

Returns the number of stones in the area around 'x'.

`area_space(x)`

Returns the amount of space in the area around 'x'.

`eye(x)`

`proper_eye(x)`

`marginal_eye(x)`

True if 'x' is an eye space for either color, a non-marginal eye space for either color, or a marginal eye space for either color, respectively.

`antisuji(x)`

Tell the move generation that 'x' is a substandard move that never should be played.

`same_dragon(x,y)`

`same_worm(x,y)`

Return true if 'x' and 'y' are the same dragon or worm respectively.

`dragonsize(x)`

`wormsize(x)`

Number of stones in the indicated dragon or worm.

`add_connect_move(x,y)`

`add_cut_move(x,y)`

`add_attack_either_move(x,y)`

`add_defend_both_move(x,y)`

Explicitly notify the move generation about move reasons for the move in the pattern.

`halfeye(x)`

Returns true if the empty intersection at 'x' is a half eye.

`remove_attack(x)`

Inform the tactical reading that a supposed attack does in fact not work.

`potential_cutstone(x)`

True if `cutstone2` field from worm data is larger than one. This indicates that saving the worm would introduce at least two new cutting points.

`not_lunch(x,y)`

Prevents the misreporting of 'x' as lunch for 'y'. For example, the following pattern tells GNU Go that even though the stone at 'a' can be captured, it should not be considered "lunch" for the dragon at 'b', because capturing it does not produce an eye:

```
XO|      ba|
O*|      O*|
oo|      oo|
?o|      ?o|
```

`> not_lunch(a,b)`

`vital_chain(x)`

Calls `vital_chain` to determine whether capturing the stone at 'x' will result in one eye for an adjacent dragon. The current implementation just checks that the stone is not a singleton on the first line.

`amalgamate(x,y)`

Amalgamate (join) the dragons at 'x' and 'y' (see [Chapter 7 \[Worms and Dragons\]](#), [page 47](#)).

`amalgamate_most_valuable(x,y,z)`

Called when 'x', 'y', 'z' point to three (preferably distinct) dragons, in situations such as this:

```
.O.X
X*OX
.O.X
```

In this situation, the opponent can play at '*', preventing the three dragons from becoming connected. However 'O' can decide which cut to allow. The helper amalgamates the dragon at 'y' with either 'x' or 'z', whichever is largest.

`make_proper_eye(x)`

This autohelper should be called when 'x' is an eyespace which is misidentified as marginal. It is reclassified as a proper eyespace (see [Section 8.2 \[Eye Space\]](#), [page 60](#)).

`remove_halfeye(x)`

Remove a half eye from the eyespace. This helper should not be run after `make_dragons` is finished, since by that time the eyespaces have already been analyzed.

`remove_eyepoint(x)`

Remove an eye point. This function can only be used before the segmentation into eyespaces.

`owl_topological_eye(x,y)`

Here 'x' is an empty intersection which may be an eye or half eye for some dragon, and 'y' is a stone of the dragon, used only to determine the color of the eyespace in question.

Returns the sum of the values of the diagonal intersections, relative to ‘x’, as explained in See [Section 8.8 \[Eye Topology\], page 67](#), equal to 4 or more if the eye at ‘x’ is false, 3 if it is a half eye, and 2 if it is a true eye.

```
owl_escape_value(x)
```

Returns the escape value at ‘x’. This is only useful in owl attack and defense patterns.

9.8 Attack and Defense Database

The patterns in ‘`attack.db`’ and ‘`defense.db`’ are used to assist the tactical reading in finding moves that attacks or defends worms. The matching is performed during `make_worms()`, at the time when the tactical status of all worms is decided. None of the classes described above are useful in these databases, instead we have two other classes.

‘D’ For each ‘O’ worm in the pattern that can be tactically captured (`worm[m][n].attack_code != 0`), the move at ‘*’ is tried. If it is found to defend the stone, this is registered as a reason for the move ‘*’ and the defense point of the worm is set to ‘*’.

‘A’ For each ‘X’ worm in the pattern, it’s tested whether the move at ‘*’ captures the worm. If that is the case, this is registered as a reason for the move at ‘*’. The attack point of the worm is set to ‘*’ and if it wasn’t attacked before, a defense is searched for.

Furthermore, ‘A’ patterns can only be used in ‘`attack.db`’ and ‘D’ patterns only in ‘`defense.db`’. Unclassified patterns may appear in these databases, but then they must work through actions to be effective.

9.9 The Connections Database

The patterns in ‘`conn.db`’ are used for helping `make_dragons()` amalgamate worms into dragons and to some extent for modifying eye spaces. The patterns in this database use the classifications ‘B’, ‘C’, and ‘e’. ‘B’ patterns are used for finding cutting points, where amalgamation should not be performed, ‘C’ patterns are used for finding existing connections, over which amalgamation is to be done, and ‘e’ patterns are used for modifying eye spaces and reevaluating lunches. There are also some patterns without classification, which use action lines to have an impact. These are matched together with the ‘C’ patterns. Further details and examples can be found in See [Chapter 7 \[Worms and Dragons\], page 47](#).

We will illustrate these databases by example. In this situation:

```
X00
0.0
...
```

‘X’ cannot play safely at the cutting point, so the ‘O’ dragons are to be amalgamated. Two patterns are matched here:

```
Pattern CC204
```

```
0
.
0
```

```

:+,C
0
A
0

;!safe_xmove(A) && !ko(A) && !xcut(A)

```

Pattern CC205

```

X0
0.

:\,C

A0
0B

;attack(A) || (!safe_xmove(B) && !ko(B) && !xcut(B))

```

The constraints are mostly clear. For example the second pattern should not be matched if the ‘X’ stone cannot be attacked and ‘X’ can play safely at ‘B’, or if ‘B’ is a ko. The constraint `!xcut(B)` means that connection has not previously been inhibited by `find_cuts`. For example consider this situation:

```

00XX
0.OX
X..0
X.O0

```

The previous pattern is matched here twice, yet ‘X’ can push in and break one of the connections. To fix this, we include a pattern:

Pattern CB11

```

?0X?
0!0X
?*!0
??0?

:8,B

?0A?
0a0B
?*b0
??0?

; !attack(A) && !attack(B) && !xplay_attack(*,a,b,*) && !xplay_attack(*,b,a,*)

```

After this pattern is found, the `xcut` autohelper macro will return true at any of the points ‘*’, ‘a’ and ‘b’. Thus the patterns CB204 and CB205 will not be matched, and the dragons will not be amalgamated.

9.10 Connections Functions

Here are the public functions in ‘`connections.c`’.

- `static void cut_connect_callback(int m, int n, int color, struct pattern *pattern, int ll, void *data)`

Try to match all (permutations of) connection patterns at (m,n). For each match, if it is a B pattern, set cutting point in worm data structure and make eye space marginal for the connection inhibiting entries of the pattern. If it is a ‘C’ pattern, amalgamate the dragons in the pattern.

- `void find_cuts(void)`

Find cutting points which should inhibit amalgamations and sever the adjacent eye space. This goes through the connection database consulting only patterns of type B. When such a function is found, the function `cut_connect_callback` is invoked.

- `void find_connections(void)`

Find explicit connection patterns and amalgamate the involved dragons. This goes through the connection database consulting patterns except those of type B, E or e. When such a function is found, the function `cut_connect_callback` is invoked.

- `void modify_eye_spaces1(void)`

Find explicit connection patterns and amalgamate the involved dragons. This goes through the connection database consulting only patterns of type E (see [Section 9.9 \[Connections Database\], page 90](#)). When such a function is found, the function `cut_connect_callback` is invoked.

- `void modify_eye_spaces1(void)`

Find explicit connection patterns and amalgamate the involved dragons. This goes through the connection database consulting only patterns of type e (see [Section 9.9 \[Connections Database\], page 90](#)). When such a function is found, the function `cut_connect_callback` is invoked.

9.11 Tuning the Pattern databases

Since the pattern databases, together with the valuation of move reasons, decide GNU Go’s personality, much time can be devoted to “tuning” them. Here are some suggestions.

If you want to experiment with modifying the pattern database, invoke with the ‘-a’ option. This will cause every pattern to be evaluated, even when some of them may be skipped due to various optimizations.

You can obtain a Smart Game Format (SGF) record of your game in at least two different ways. One is to use CGoban to record the game. You can also have GNU Go record the game in Smart Game Format, using the ‘-o’ option. It is best to combine this with ‘-a’. Do not try to read the SGF file until the game is finished and you have closed the

game window. This does not mean that you have to play the game out to its conclusion. You may close the CGoban window on the game and GNU Go will close the SGF file so that you can read it.

If you record a game in SGF form using the ‘-o’ option, GNU Go will add labels to the board to show all the moves it considered, with their values. This is an extremely useful feature, since one can see at a glance whether the right moves with appropriate weights are being proposed by the move generation.

First, due to a bug of unknown nature, it occasionally happens that GNU Go will not receive the SIGTERM signal from CGoban that it needs to know that the game is over. When this happens, the SGF file ends without a closing parenthesis, and CGoban will not open the file. You can fix the file by typing:

```
echo ")" >>[filename]
```

at the command line to add this closing parenthesis. Or you could add the) using an editor.

Move values exceeding 99 (these should be rare) can be displayed by CGoban but you may have to resize the window in order to see all three digits. Grab the lower right margin of the CGoban window and pull it until the window is large. All three digits should be visible.

If you are playing a game without the ‘-o’ option and you wish to analyze a move, you may still use CGoban’s “Save Game” button to get an SGF file. It will not have the values of the moves labelled, of course.

Once you have a game saved in SGF format, you can analyze any particular move by running:

```
gnugo -l [filename] -L [move number] -t -a -w
```

to see why GNU Go made that move, and if you make changes to the pattern database and recompile the program, you may ask GNU Go to repeat the move to see how the behavior changes. If you’re using emacs, it’s a good idea to run GNU Go in a shell in a buffer (M-x shell) since this gives good navigation and search facilities.

Instead of a move number, you can also give a board coordinate to ‘-L’ in order to stop at the first move played at this location. If you omit the ‘-L’ option, the move after those in the file will be considered.

If a bad move is proposed, this can have several reasons. To begin with, each move should be valued in terms of actual points on the board, as accurately as can be expected by the program. If it’s not, something is wrong. This may have two reasons. One possibility is that there are reasons missing for the move or that bogus reasons have been found. The other possibility is that the move reasons have been miscalculated by the move valuation functions. Tuning of patterns is with a few exceptions a question of fixing the first kind of problems.

If there are bogus move reasons found, search through the trace output for the pattern that is responsible. (Some move reasons, e.g. most tactical attack and defense, do not originate from patterns. If no pattern produced the bogus move reason, it is not a

tuning problem.) Probably this pattern was too general or had a faulty constraint. Try to make it more specific or correct bugs if there were any. If the pattern and the constraint looks right, verify that the tactical reading evaluates the constraint correctly. If not, this is either a reading bug or a case where the reading is too complicated for GNU Go.

If a connecting move reason is found, but the strings are already effectively connected, there may be missing patterns in `'conn.db'`. Similarly, worms may be incorrectly amalgamated due to some too general or faulty pattern in `'conn.db'`. To get trace output from the matching of patterns in `'conn.db'` you need to add a second `'-t'` option.

If a move reason is missing, there may be a hole in the database. It could also be caused by some existing pattern being needlessly specific, having a faulty constraint, or being rejected due to a reading mistake. Unless you are familiar with the pattern databases, it may be hard to verify that there really is a pattern missing. Look around the databases to try to get a feeling for how they are organized. (This is admittedly a weak point of the pattern databases, but the goal is to make them more organized with time.) If you decide that a new pattern is needed, try to make it as general as possible, without allowing incorrect matches, by using proper classification from among `snOoXx` and constraints. The reading functions can be put to good use. The reason for making the patterns as general as they can be is that we need a smaller number of them then, which makes the database much easier to maintain. Of course, if you need too complicated constraints, it's usually better to split the pattern.

If a move has the correct set of reasons but still is misevaluated, this is usually not a tuning problem. There are, however, some possibilities to work around these mistakes with the use of patterns. In particular, if the territorial value is off because `delta_terri()` give strange results, the `(min)terri` and `maxterri` values can be set by patterns as a workaround. This is typically done by the endgame patterns, where we can know the (minimum) value fairly well from the pattern. If it should be needed, `(min)value` and `maxvalue` can be used similarly. These possibilities should be used conservatively though, since such patterns are likely to become obsolete when better (or at least different) functions for e.g. territory estimation are being developed.

In order to choose between moves with the same move reasons, e.g. moves that connect two dragons in different ways, patterns with a nonzero shape value should be used. These should give positive shape values for moves that give good shape or good aji and negative values for bad shape and bad aji. Notice that these values are additive, so it's important that the matches are unique.

Sente moves are indicated by the use of the pattern followup value. This can usually not be estimated very accurately, but a good rule is to be rather conservative. As usual it should be measured in terms of actual points on the board. These values are also additive so the same care must be taken to avoid unintended multiple matches.

You can also get a visual display of the dragons using the `'-T'` option. The default GNU Go configuration tries to build a version with color support using either curses or the ansi escape sequences. You are more likely to find color support in `rxvt` than `xterm`, at least on many systems, so we recommend running:

```
gnugo -l [filename] -L [move number] -T
```

in an `rxvt` window. If you do not see a color display, and if your host is a GNU/Linux machine, try this again in the Linux console.

Worms belonging to the same dragon are labelled with the same letters. The colors indicate the value of the field `dragon.safety`, which is set in `'moyo.c'`.

Green: GNU Go thinks the dragon is alive

Yellow: Status unknown

Blue: GNU Go thinks the dragon is dead

Red: Status critical (1.5 eyes) or weak by the algorithm
in `'moyo.c'`

If you want to get the same game over and over again, you can eliminate the randomness in GNU Go's play by providing a fixed random seed with the `'-r'` option.

9.12 Implementation

The pattern code in GNU Go is fairly straightforward conceptually, but because the matcher consumes a significant part of the time in choosing a move, the code is optimized for speed. Because of this there are implementation details which obscure things slightly.

In GNU Go, the ascii `' .db'` files are precompiled into tables (see `'patterns.h'`) by a standalone program `'mkpat.c'`, and the resulting `' .c'` files are compiled and linked into the main GNU Go executable.

Each pattern is compiled to a header, and a sequence of elements, which are (notionally) checked sequentially at every position and orientation of the board. These elements are relative to the pattern 'anchor' (or origin). One 'X' or 'O' stone is (arbitrarily) chosen to represent the origin of the pattern. (We cannot dictate one or the other since some patterns contain only one colour or the other.) All the elements are in co-ordinates relative to this position. So a pattern matches "at" board position (m, n, o) if the the pattern anchor stone is on (m, n) , and the other elements match the board when the pattern is transformed by transformation number 'o'. (See below for the details of the transformations, though these should not be necessary)

9.13 Symmetry and transformations

In general, each pattern must be tried in each of 8 different permutations, to reflect the symmetry of the board. But some patterns have symmetries which mean that it is unnecessary (and therefore inefficient) to try all eight. The first character after the `' : '` can be one of `'8', '|', '\', '/', 'X', '-', '+'`, representing the axes of symmetry. It can also be `'0'`, representing symmetry under 180 degrees rotation.

```
transformation  I  -  |  .  \  l  r  /
                ABC GHI CBA  IHG  ADG CFI GDA  IFC
                DEF DEF FED  FED  BEH BEH HEB  HEB
                GHI ABC  IHG  CBA  CFI ADG IFC  GDA
```

```
      a  b  c  d  e  f  g  h
```

Then if the pattern has the following symmetries, the following are true:

```
|  c=a, d=b, g=e, h=f
-  b=a, c=d, e=f, g=h
\  e=a, g=b, f=c, h=d
```

```

/  h=a, f=b, g=c, e=d
0  a=d, b=c, e=h, f=g
X  a=d=e=h, b=c=f=g
+  a=b=c=d, e=f=g=h

```

We can choose to use transformations a,d,f,g as the unique transformations for patterns with either ‘|’, ‘-’, ‘\’, or ‘/’ symmetry.

Thus we choose to order the transformations a,g,d,f,h,b,e,c and choose first 2 for ‘X’ and ‘+’, the first 4 for ‘|’, ‘-’, ‘/’, and ‘\’, the middle 4 for ‘0’, and all 8 for non-symmetrical patterns.

Each of the reflection operations (e-h) is equivalent to reflection about one arbitrary axis followed by one of the rotations (a-d). We can choose to reflect about the axis of symmetry (which causes no net change) and can therefore conclude that each of e-h is equivalent to the reflection (no-op) followed by a-d. This argument therefore extends to include ‘-’ and ‘/’ as well as ‘|’ and ‘\’.

9.14 Implementation Details

1. An entry in the pattern header states whether the anchor is an ‘X’ or an ‘0’. This helps performance, since all transformations can be rejected at once if the anchor stone does not match. (Ideally, we could just define that the anchor is always ‘0’ or always ‘X’, but some patterns contain no ‘0’ and some contain no ‘X’.)
2. The pattern header contains the size of the pattern (ie the co-ordinates of the top left and bottom right elements) relative to the anchor. This allows the pattern can be rejected quickly if there is not room for the pattern to fit around the anchor stone in a given orientation (ie it is too near the edge of the board). The bounding box information must first be transformed like the elements before it can be tested, and after transforming, we need to work out where the top-left and bottom-right corners are.
3. The edge constraints are implemented by notionally padding the pattern with rows or columns of ‘?’ until it is exactly 19 (or whatever the current board size is) elements wide or high. Then the pattern is quickly rejected by (ii) above if it is not at the edge. So the example pattern above is compiled as if it was written

```

"example"
.00????????????????
*XX????????????????
o????????????????
:8,80

```

4. The elements in a pattern are sorted so that non-space elements are checked before space elements. It is hoped that, for most of the game, more squares are empty, and so the pattern can be more quickly rejected doing it this way.
5. The actual tests are performed using an ‘and-compare’ sequence. Each board position is a 2-bit quantity. %00 for empty, %01 for ‘0’, %10 for ‘X’. We can test for an exact match by and-ing with %11 (no-op), then comparing with 0, 1 or 2. The test for ‘o’ is

the same as a test for 'not-X', ie not %10. So and with %01 should give 0 if it matches. Similarly 'x' is a test that bit 0 is not set.

9.15 The “Grid” Optimization

The comparisons between pattern and board are performed as 2-bit bitwise operations. Therefore they can be performed in parallel, 16-at-a-time on a 32-bit machine.

Suppose the board is layed out as follows :

```
.X.0....00
XXXX0.....
.X..000000
X.X.....
....X...0.
```

which is internally stored internally in a 2d array (binary)

```
00 10 00 01 00 00 00 00 01 01
10 10 10 10 01 00 00 00 00 00
00 10 00 00 01 01 01 01 01 01
10 00 10 00 00 00 00 00 00 00
00 00 00 00 10 00 00 00 01 00
```

we can compile this to a composite array in which each element stores the state of a 4x4 grid of squares :

```
???????? ???? ?????? ...
??001000 00100001 10000100
??101010 10101010 10101001
??001000 00100000 10000001

??001000 00100001 ...
??101010 10101010
??001000 00100000
??001000 10001000

...

??100010 ...
??000000
????????
????????
```

Where '??' is off the board.

We can store these 32-bit composites in a 2d merged-board array, substituting the illegal value %11 for '??'.

Similarly, for each pattern, `mkpat` produces appropriate 32-bit and-value masks for the pattern elements near the anchor. It is a simple matter to test the pattern with a similar test to (5) above, but for 32-bits at a time.

9.16 The Joseki Compiler

GNU Go includes a joseki compiler in `'patterns/joseki.c'`. This processes an SGF file (with variations) and produces a sequence of patterns which can then be fed back into `mkpat`. The joseki database is currently in files in `'patterns/'` called `'hoshi.sgf'`, `'komoku.sgf'`, `'sansan.sgf'`, `'mokuhazushi.sgf'` and `'takamoku.sgf'`. This division can be revised whenever need arises.

The SGF files are transformed into the pattern database `'db'` format by the program in `'joseki.c'`. These files are in turn transformed into C code by the program in `'mkpat.c'` and the C files are compiled and linked into the GNU Go binary.

Not every node in the SGF file contributes a pattern. The nodes which contribute patterns have the joseki in the upper right corner, with the boundary marked with a square mark and other information to determine the resulting pattern marked in the comments.

The intention is that the move valuation should be able to choose between the available variations by normal valuation. When this fails the primary workaround is to use shape values to increase or decrease the value. It is also possible to add antisuji variations to forbid popular suboptimal moves. As usual constraints can be used, e.g. to condition a variation on a working ladder.

The joseki format has the following components for each SGF node:

- A square mark (SQ or MA property) to decide how large part of the board should be included in the pattern.
- A move ('W' or 'B' property) with the natural interpretation. If the square mark is missing or the move is a pass, no pattern is produced for the node.
- Optional labels (LB property), which must be a single letter each. If there is at least one label, a constraint diagram will be produced with these labels.
- A comment ('C' property). As the first character it should have one of the following characters to decide its classification:
 - 'U' - urgent move
 - 'S' or 'J' - standard move
 - 's' or 'j' - lesser joseki
 - 'T' - trick move
 - 't' - minor joseki move (tenuki OK)
 - 'O' - antisuji ('A' can also be used)

The rest of the line is ignored, as is the case of the letter. If neither of these is found, it's assumed to be a standard joseki move.

In addition to this, rows starting with the following characters are recognized:

- '#' - Comments. These are copied into the patterns file, above the diagram.
- ';' - Constraints. These are copied into the patterns file, below the constraint diagram.

- ‘>’ - Actions. These are copied into the patterns file, below the constraint diagram.
- ‘:’ - Colon line. This is a little more complicated, but the colon line of the produced patterns always start out with ":8,s" for transformation number and sacrifice pattern class (it usually isn't a sacrifice, but it's pointless spending time checking for tactical safety). Then a joseki pattern class character is appended and finally what is included on the colon line in the comment for the SGF node.

Example: If the comment in the SGF file looks like

```
F
:C,shape(3)
;xplay_attack(A,B,C,D,*)
```

the generated pattern will have a colon line

```
:8,sjC,shape(3)
```

and a constraint

```
;xplay_attack(A,B,C,D,*)
```

9.17 Ladders in Joseki

As an example of how to use autohelpers with the Joseki compiler, we consider an example where a Joseki is bad if a ladder fails. Assume we have the taisha and are considering connecting on the outside with the pattern

```
-----+
.....|
.....|
...XX...|
...OXO...|
...*O...|
...X...|
.....|
.....|
```

But this is bad unless we have a ladder in our favor. To check this we add a constraint which may look like

```
-----+
.....|
.....|
...XX...|
...OXO...|
...*OAC...|
...DB...|
.....|
.....|
```

```
;oplay_attack(*,A,B,C,D)
```

In order to accept the pattern we require that the constraint on the semicolon line evaluates to true. This particular constraint has the interpretation "Play with alternating

colors, starting with ‘O’, on the intersections ‘*’, ‘A’, ‘B’, and ‘C’. Then check whether the stone at ‘D’ can be captured." I.e. play to this position

```

-----+
.....|
.....|
...XX..|
...OXO..|
...OOXX..|
....XO..|
.....|
.....|

```

and call `attack()` to see whether the lower ‘X’ stone can be captured. This is not limited to ladders, but in this particular case the reading will of course involve a ladder.

The constraint diagram above with letters is how it looks in the ‘.db’ file. The joseki compiler knows how to create these from labels in the SGF node. ‘Cgoban’ has an option to create one letter labels, but this ought to be a common feature for SGF editors.

Thus in order to implement this example in SGF, one would add labels to the four intersections and a comment:

```
;oplay_attack(*,A,B,C,D)
```

The appropriate constraint (autohelper macro) will then be added to the Joseki ‘.db’ file.

9.18 Corner Matcher

GNU Go uses a special matcher for joseki patterns. It has certain constraints on the patterns it can match, but is much faster and takes far less space to store patterns than the standard matcher.

Patterns used with corner matcher have to qualify the following conditions:

- They must be matchable only at a corner of the board (hence the name of the matcher).
- They can consist only of ‘O’, ‘X’ and ‘.’ elements.
- Of all pattern values (see [Section 9.3 \[Pattern Values\], page 80](#)), corner matcher only support `shape(x)`. This is not because the matcher cannot handle other values in principle, just they are currently not used in joseki databases.

Corner matcher was specifically designed for joseki patterns and they of course satisfy all the conditions above. With some modifications corner matcher could be used for fuseki patterns as well, but fullboard matcher does its work just fine.

The main idea of the matcher is very same to the one of DFA matcher (see [Section 10.3 \[Pattern matching with DFA\], page 106](#)): check all available patterns at once, not a single pattern at a time. A modified version of DFA matcher could be used for joseki pattern matching, but its database would be very large. Corner matcher capitalizes on the fact that there are relatively few stones in each such pattern.

Corner pattern database is organized into a tree. Nodes of the tree are called “variations”. Variations represent certain sets of stones in a corner of the board. Root variation corresponds to an empty corner and a step down the tree is equivalent to adding a stone to the corner. Each variation has several properties:

- stone position relative to the corner,
- a flag determining whether the stone color must be equal to the first matched stone color,
- number of stones in the corner area (see below) of the variation stone.

By corner area we define a rectangle which corners are the current corner of the board and the position of the stone (inclusive). For instance, if the current board corner is A19 then corner area of a stone at C18 consists of A18, A19, B18, B19, C18 and C19.

Variation which is a direct child of the root variation matches if there is any stone at the variation position and the stone is alone in its corner area.

Variation at a deeper level of the tree matches if there is a stone of specified color in variation position and the number of stones in its corner area is equal to the number specified in variation structure.

When a certain variation matches, all its children has to be checked recursively for a match.

All leaf variations and some inner ones have patterns attached to them. For a pattern to match, it is required that its *parent* variation matches. In addition, it is checked that pattern is being matched for the appropriate color (using its variation “stone color” field) and that the number of stones in the area where the pattern is being matched is indeed equal to the number of stones in the pattern. The “stone position” property of the pattern variation determines the move suggested by the pattern.

Consider this joseki pattern which has four stones:

```

-----+
.....|
.....|
.O*...|
.XXO..|
.....|
.....|

```

To encode it for the corner matcher, we have to use five variations, each next being a child of previous:

Tree level	Position	Color	Number of stones
1	R16	“same”	1
2	P17	“same”	1
3	Q16	“other”	2
4	P16	“other”	4
5	Q17	“same”	1

The fifth variation should have an attached pattern. Note that the stone color for the fifth variation is “same” because the first matched stone for this pattern is ‘O’ which stands for the stones of the player to whom moves are being suggested with ‘*’.

The tree consists of all variations for all patterns combined together. Variations for each patterns are sorted to allow very quick tree branch rejection and at the same time keep the database small enough. More details can be found in comments in file ‘mkpat.c’

Corner matcher resides in ‘matchpat.c’ in two functions: `corner_matchpat()` and `do_corner_matchpat()`. The former computes `num_stones[]` array which holds number of

stones in corner areas of different intersections of the board for all possible transformations. `corner_matchpat()` also matches top-level variations. `do_corner_matchpat()` is responsible for recursive matching on the variation tree and calling callback function upon pattern match.

Tree-like database for corner matcher is generated by `mkpat` program. Database generator consists of several functions, most important are: `corner_best_element()`, `corner_variation_new()`, `corner_follow_variation()` and `corner_add_pattern()`.

9.19 Emacs Mode for Editing Patterns

If you use GNU Emacs (XEmacs might work too), you can try a special mode for editing GNU Go pattern databases. The mode resides in `'patterns/gnugo-db.el'`.

Copy the file to `'emacs/site-lisp'` directory. You can then load the mode with `(require 'gnugo-db)`. It makes sense to put this line into your configuration file (`'~/.emacs'`). You can either use `gnugo-db-mode` command to switch to pattern editing mode, or use the following code snippet to make Emacs do this automatically upon opening a file with `'.db'` suffix:

```
(setq auto-mode-alist
      (append
        auto-mode-alist
        '(("\\.db\\'" . gnugo-db-mode))))
```

Pattern editing mode provides the following features:

- highlighting of keywords (`Pattern`, `goal_elements` and `callback_data`) and comments,
- making paragraphs equal to patterns (`M-h`, `M-{'`, `M-}'` and others operate on patterns),
- commands for pattern creation with automatic name selection (`C-c C-p`) and copying main diagram to constraint diagram (`C-c C-c`),
- automated indentation of constraints and side comments (pattern descriptions).

B
C4A
5139
628
7

gives the string "OO?X.*O*?*" where "?" means 'don't care' and "*" means 'don't care, can even be out of board'.

So we can forget that we are dealing with two dimensional patterns and consider linear patterns.

10.2 What is a DFA

The acronym DFA means Deterministic Finite state Automaton (See <http://www.eti.pg.gda.pl/~jandac/th> or *Hopcroft & Ullman "Introduction to Language Theory"* for more details). DFA are common tools in compilers design (Read *Aho, Ravi Sethi, Ullman "COMPILERS: Principles, Techniques and Tools"* for a complete introduction), a lot of powerfull text searching algorithm like *Knuth-Morris-Pratt* or *Boyer-Moore* algorithms are based on DFA's (See <http://www-igm.univ-mlv.fr/~lecroq/string/> for a bibliography of pattern matching algorithms).

Basically, a DFA is a set of *states* connected by labeled *transitions*. The labels are the values read on the board, in GNU Go these values are EMPTY, WHITE, BLACK or OUT_BOARD, denoted respectively by '.', 'O', 'X' and '#'.

The best way to represent a DFA is to draw its transition graph: the pattern "????..X" is recognized by the following DFA:

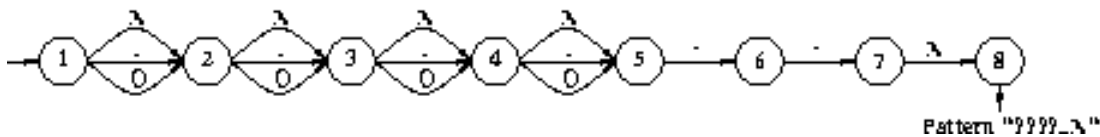

This means that starting from state [1], if you read '.', 'X' or 'O' on the board, go to state [2] and so on until you reach state [5]. From state [5], if you read '.', go to state [6] otherwise go to error state [0]. And so on until you reach state [8]. As soon as you reach state [8], you recognize Pattern "????..X"

Adding a pattern like "XXo" ('o' is a wildcard for not 'X') will transform directly the automaton by synchronization product ([Section 10.4 \[Building the DFA\], page 107](#)). Consider the following DFA:

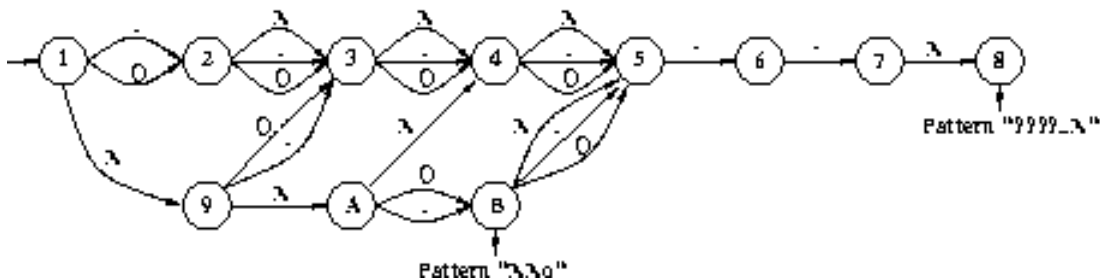

By adding a special *error* state and completing each state by a transition to error state when there is none, we transform easily a DFA in a *Complete Deterministic Finite state Automaton* (C DFA). The synchronization product (Section 10.4 [Building the DFA], page 107) is only possible on C DFA's.

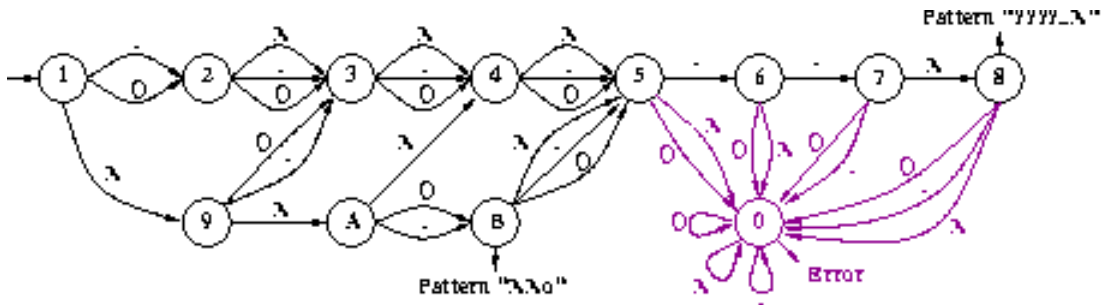

The graph of a C DFA is coded by an array of states: The 0 state is the "error" state and the start state is 1.

state	.	0	X	#	att
1	2	2	9	0	
2	3	3	3	0	
3	4	4	4	0	
5	6	0	0	0	
6	7	0	0	0	
7	0	0	8	0	
8	0	0	0	0	Found pattern "????..X"
9	3	3	A	0	
A	B	B	4	0	
B	5	5	5	0	Found pattern "XXo"

To each state we associate an often empty list of attributes which is the list of pattern indexes recognized when this state is reached. In "dfa.h" this is basically represented by two stuctures:

```

/* dfa state */
typedef struct state
{
    int next[4]; /* transitions for EMPTY, BLACK, WHITE and OUT_BOARD */
    attrib_t *att;
}
state_t;

/* dfa */
typedef struct dfa
{
    attrib_t *indexes; /* Array of pattern indexes */
    int maxIndexes;

    state_t *states; /* Array of states */
    int maxStates;
}
dfa_t;

```

10.3 Pattern matching with DFA

Recognizing with a DFA is very simple and thus very fast (See 'scan_for_pattern()' in the 'engine/matchpat.c' file).

Starting from the start state, we only need to read the board following the spiral path, jump from states to states following the transitions labelled by the values read on the board and collect the patterns indexes on the way. If we reach the error state (zero), it means that no more patterns will be matched. The worst case complexity of this algorithm is $O(m)$ where m is the size of the biggest pattern.

Here is an example of scan:

First we build a minimal DFA recognizing these patterns: "X..X", "X???", "X.OX" and "X?oX". Note that wildcards like '?', 'o', or 'x' give multiple out-transitions.

state	.	0	X	#	att
1	0	0	2	0	
2	3	10	10	0	
3	4	7	9	0	
4	5	5	6	0	
5	0	0	0	0	2
6	0	0	0	0	4 2 1
7	5	5	8	0	
8	0	0	0	0	4 2 3
9	5	5	5	0	
10	11	11	9	0	
11	5	5	12	0	
12	0	0	0	0	4 2

We perform the scan of the string "X..XXO...." starting from state 1:

Current state: 1, substring to scan : X..XXO....

We read an 'X' value, so from state 1 we must go to state 2.

Current state: 2, substring to scan : ..XXO....

We read a '.' value, so from state 2 we must go to state 3 and so on ...

Current state: 3, substring to scan : .XXO....

Current state: 4, substring to scan : XXO....

Current state: 6, substring to scan : X0....

Found pattern 4

Found pattern 2

Found pattern 1

After reaching state 6 where we match patterns 1,2 and 4, there is no out-transitions so we stop the matching. To keep the same match order as in the standard algorithm, the patterns indexes are collected in an array and sorted by indexes.

10.4 Building the DFA

The most flavouring point is the building of the minimal DFA recognizing a given set of patterns. To perform the insertion of a new pattern into an already existing DFA one must completely rebuild the DFA: the principle is to build the minimal C DFA recognizing the new pattern to replace the original C DFA with its *synchronised product* by the new one.

We first give a formal definition: Let \mathbf{L} be the left C DFA and \mathbf{R} be the right one. Let \mathbf{B} be the *synchronised product* of \mathbf{L} by \mathbf{R} . Its states are the couples (\mathbf{l}, \mathbf{r}) where \mathbf{l} is a state of \mathbf{L} and \mathbf{r} is a state of \mathbf{R} . The state $(\mathbf{0}, \mathbf{0})$ is the error state of \mathbf{B} and the state $(\mathbf{1}, \mathbf{1})$ is its initial state. To each couple (\mathbf{l}, \mathbf{r}) we associate the union of patterns recognized in both \mathbf{l} and \mathbf{r} . The transitions set of \mathbf{B} is the set of transitions $(\mathbf{l1}, \mathbf{r1}) \xrightarrow{\mathbf{a}} (\mathbf{l2}, \mathbf{r2})$ for each symbol 'a' such that both $\mathbf{l1} \xrightarrow{\mathbf{a}} \mathbf{l2}$ in \mathbf{L} and $\mathbf{r1} \xrightarrow{\mathbf{a}} \mathbf{r2}$ in \mathbf{R} .

The maximal number of states of \mathbf{B} is the product of the number of states of \mathbf{L} and \mathbf{R} but almost all this states are non reachable from the initial state $(\mathbf{1}, \mathbf{1})$.

The algorithm used in function `'sync_product()'` builds the minimal product DFA only by keeping the reachable states. It recursively scans the product CDFA by following simultaneously the transitions of **L** and **R**. A hast table (`gtest`) is used to check if a state **(l,r)** has already been reached, the reachable states are remapped on a new DFA. The CDFA thus obtained is minimal and recognizes the union of the two patterns sets.

For example these two CDFA's:

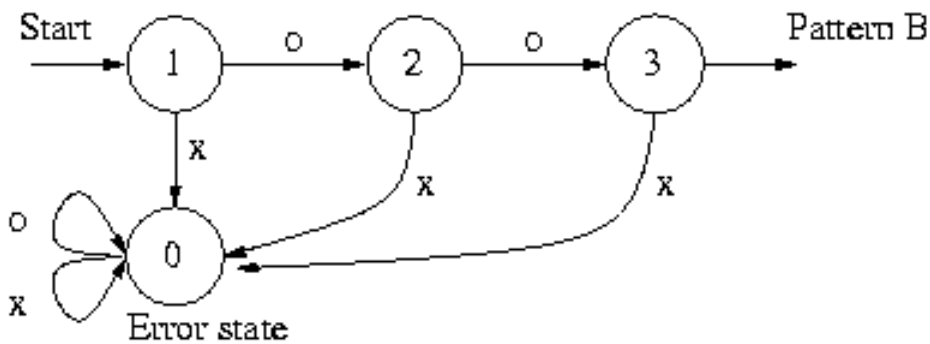
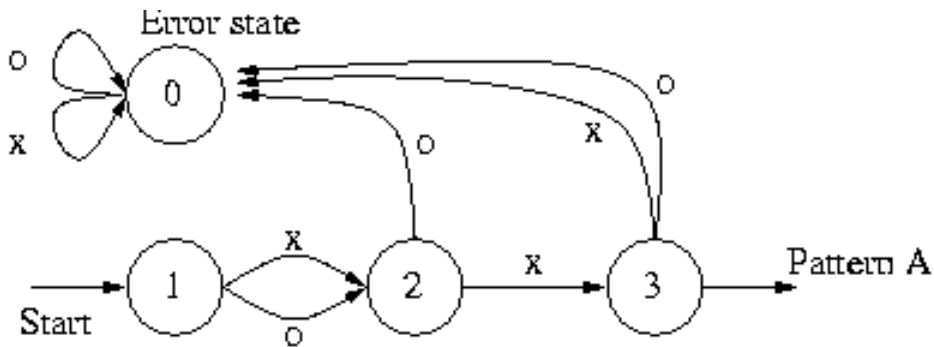

Give by synchronization product the following one:

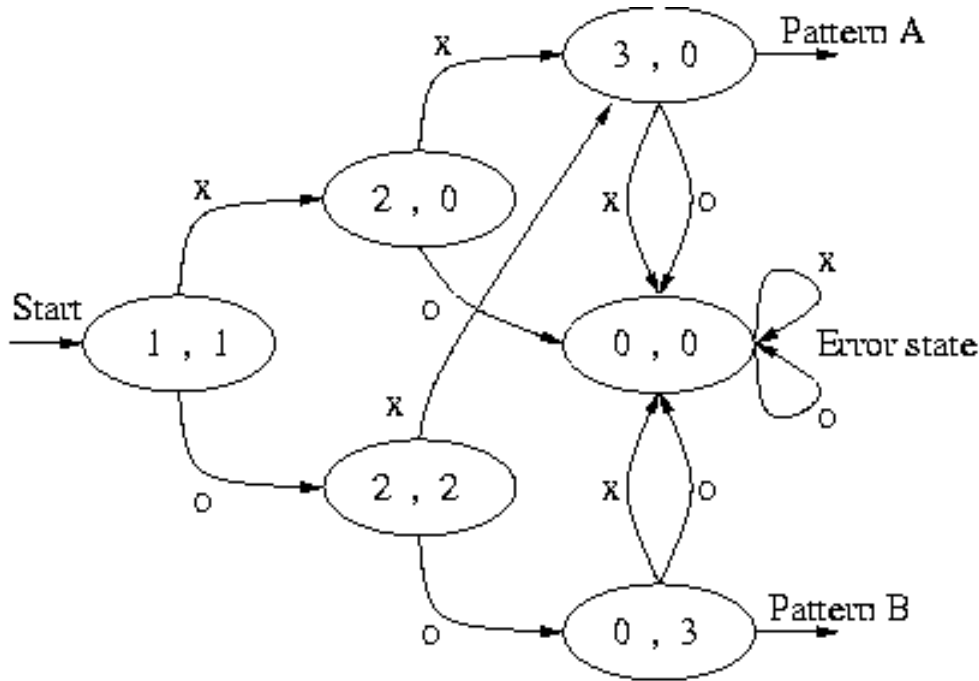

It is possible to construct a special pattern database that generates an "explosive" automaton: the size of the DFA is in the worst case exponential in the number of patterns it recognizes. But it doesn't occur in practical situations: the DFA size tends to be *stable*. By *stable* we mean that if we add a pattern which greatly increases the size of the DFA it also increases the chance that the next added pattern does not increase its size at all. Nevertheless there are many ways to reduce the size of the DFA. Good compression methods are explained in *Aho, Ravi Sethi, Ullman "COMPILERS: Principles, Techniques and Tools" chapter Optimization of DFA-based pattern matchers.*

10.5 Incremental Algorithm

The incremental version of the DFA pattern matcher is not yet implemented in GNU Go but we explain here how it will work. By definition of a deterministic automaton, scanning the same string will reach the same states every time.

Each reached state during pattern matching is stored in a stack `top_stack[i][j]` and `state_stack[i][j][stack_idx]`. We use one stack by intersection (i, j) . A pre-computed reverse path list allows to know for each couple of board intersections (x, y) its position `reverse(x, y)` in the spiral scan path starting from $(0, 0)$.

When a new stone is put on the board at (lx, ly) , the only work of the pattern matcher is:

```
for(each stone on the board at (i,j))
  if(reverse(lx-i,ly-j) < top_stack[i][j])
  {
    begin the dfa scan from the state
    state_stack[i][j][reverse(lx-i,ly-j)];
  }
```

In most situations `reverse(lx-i,ly-j)` will be inferior to `top_stack[i][j]`. This should speedup a lot pattern matching.

10.6 Some DFA Optimizations

The DFA is constructed to minimize jumps in memory making some assumptions about the frequencies of the values: the `EMPTY` value is supposed to appear often on the board, so the the `'.'` transition are almost always successors in memory. The `OUT_BOARD` are supposed to be rare, so `'#'` transitions will almost always imply a big jump.

11 Tactical reading

The process of visualizing potential moves done by you and your opponent to learn the result of different moves is called "reading". GNU Go does three distinct types of reading: *tactical reading* which typically is concerned with the life and death of individual strings, *Owl reading* which is concerned with the life and death of dragons, and *connection reading*. In this Chapter, we document the tactical reading code, which is in ‘`engine/reading.c`’.

11.1 Reading Basics

What we call *Tactical Reading* is the analysis whether there is a direct capture of a single string, or whether there is a move to prevent such a direct capture.

If the reading module finds out that the string can get captured, this answer should (usually) be trusted. However, if it says it can be defended, this does not say as much. It is often the case that such a string has no chance to make a life, but that it cannot be captured within the horizon (and the cutoff heuristics) of the tactical reading.

The tactical reading is done by the functions in ‘`engine/reading.c`’. It is a minimax search that declares win for the attacker once he can physically take the string off board, whereas the defense is considered successful when the string has sufficiently many liberties. A string with five liberties is always considered alive. At higher depth within the search tree even fewer liberties cause GNU Go to give up the attack, See [\[depthparams\]](#), page 112.

The reading code makes use of a stack onto which board positions can be pushed. The parameter `stackp` is zero if GNU Go is examining the true board position; if it is higher than zero, then GNU Go is examining a hypothetical position obtained by playing several moves.

The most important public reading functions are `attack` and `find_defense`. These are wrappers for functions `do_attack` and `do_find_defense` which are declared statically in ‘`reading.c`’. The functions `do_attack` and `do_find_defense` call each other recursively.

11.1.1 Organization of the reading code

The function `do_attack` and `do_find_defense` are wrappers themselves and call `attack1`, `attack2`, `attack3` or `attack4` resp. `defend1`, `defend1`, `defend1` or `defend1` depending on the number of liberties.

These are fine-tuned to generate and try out the moves in an efficient order. They generate a few moves themselves (mostly direct liberties of the string), and then call helper functions called `..._moves` which suggest less obvious moves. Which of these functions get called depends on the number of liberties and of the current search depth.

11.1.2 Return Codes

The return codes of the reading (and owl) functions and owl can be 0, `KO_B`, `KO_A` or `WIN`. Each reading function determines whether a particular player (assumed to have the move) can solve a specific problem, typically attacking or defending a string.

A return code of `WIN` means success, 0 failure, while `KO_A` and `KO_B` are success conditioned on ko. A function returns `KO_A` if the position results in ko and that the player to move will get the first ko capture (so the opponent has to make the first ko threat). A return code of `KO_B` means that the player to move will have to make the first ko threat.

If GNU Go is compiled with the configure option ‘`--enable-experimental-owl-ext`’ then the owl functions also have possible return codes of `GAIN` and `LOSS`. A code of `GAIN` means that the attack (or defense) does not succeed, but that in the process of trying to attack or defend, an opponent’s worm is captured. A code of `LOSS` means that the attack or defense succeeds, but that another friendly worm dies during the attack or defense.

11.1.3 Reading cutoff and depth parameters

Depth of reading is controlled by the parameters `depth` and `branch_depth`. The `depth` has a default value `DEPTH` (in ‘`liberty.h`’), which is set to 16 in the distribution, but it may also be set at the command line using the ‘`-D`’ or ‘`--depth`’ option. If `depth` is increased, GNU Go will be stronger and slower. GNU Go will read moves past `depth`, but in doing so it makes simplifying assumptions that can cause it to miss moves.

Specifically, when `stackp > depth`, GNU Go assumes that as soon as the string can get 3 liberties it is alive. This assumption is sufficient for reading ladders.

The `branch_depth` is typically set a little below `depth`. Between `branch_depth` and `depth`, attacks on strings with 3 liberties are considered, but branching is inhibited, so fewer variations are considered.

%%Currently the reading code does not try to defend a string by %attacking a boundary string with more than two liberties. Because %of this restriction, it can make oversights. A symptom of this is %two adjacent strings, each having three or four liberties, each %classified as `DEAD`. To resolve such situations, a function `small_semeai()` (in ‘`engine/semeai.c`’) looks for such %pairs of strings and corrects their classification.

The `backfill_depth` is a similar variable with a default 12. Below this depth, GNU Go will try "backfilling" to capture stones. For example in this situation:

```
.000000.   on the edge of the board, O can capture X but
00XXXXXO   in order to do so he has to first play at a in
.aObX.XO   preparation for making the atari at b. This is
-----   called backfilling.
```

Backfilling is only tried with `stackp <= backfill_depth`. The parameter `backfill_depth` may be set using the ‘`-B`’ option.

The `fourlib_depth` is a parameter with a default of only 7. Below this depth, GNU Go will try to attack strings with four liberties. The `fourlib_depth` may be set using the ‘`-F`’ option.

The parameter `ko_depth` is a similar cutoff. If `stackp < ko_depth`, the reading code will make experiments involving taking a ko even if it is not legal to do so (i.e., it is hypothesized that a remote ko threat is made and answered before continuation). This parameter may be set using the ‘`-K`’ option.

- `int attack(int str, int *move)`

Determines if the string at `str` can be attacked, and if so, `*move` returns the attacking move, unless `*movei` is a null pointer. (Use null pointers if you are interested in the result of the attack but not the attacking move itself.) Returns `WIN`, if the attack succeeds, 0 if it fails, and `KO_A` or `KO_B` if the result depends on ko [\[Return Codes\]](#), page 111.

- `find_defense(int str, int *move)`
Attempts to find a move that will save the string at `str`. It returns true if such a move is found, with `*move` the location of the saving move (unless `*move` is a null pointer). It is not checked that tenuki defends, so this may give an erroneous answer if `!attack(str)`. Returns KO_A or KO_B if the result depends on ko See [\[Return Codes\]](#), page 111.
- `safe_move(int str, int color) :`
The function `safe_move(str, color)` checks whether a move at `str` is illegal or can immediately be captured. If `stackp==0` the result is cached. If the move only can be captured by a ko, it's considered safe. This may or may not be a good convention.

11.2 Hashing of Positions

To speed up the reading process, we note that a position can be reached in several different ways. In fact, it is a very common occurrence that a previously checked position is rechecked, often within the same search but from a different branch in the recursion tree.

This wastes a lot of computing resources, so in a number of places, we store away the current position, the function we are in, and which worm is under attack or to be defended. When the search for this position is finished, we also store away the result of the search and which move made the attack or defense succeed.

All this data is stored in a hash table, sometimes also called a transposition table, where Go positions are the key and results of the reading for certain functions and groups are the data. You can increase the size of the Hash table using the `'-M'` or `'--memory'` option see [Section 3.9 \[Invoking GNU Go\]](#), page 14.

The hash table is created once and for all at the beginning of the game by the function `hashtable_new()`. Although hash memory is thus allocated only once in the game, the table is reinitialized at the beginning of each move by a call to `hashtable_clear()` from `genmove()`.

11.2.1 Calculation of the hash value

The hash algorithm is called Zobrist hashing, and is a standard technique for go and chess programming. The algorithm as used by us works as follows:

1. First we define a *go position*. This positions consists of
 - the actual board, i.e. the locations and colors of the stones
 - A *ko point*, if a ko is going on. The ko point is defined as the empty point where the last single stone was situated before it was captured.

It is not necessary to specify the color to move (white or black) as part of the position. The reason for this is that read results are stored separately for the various reading functions such as `attack3`, and it is implicit in the calling function which player is to move.

2. For each location on the board we generate random numbers:
 - A number which is used if there is a white stone on this location
 - A number which is used if there is a black stone on this location

- A number which is used if there is a ko on this location

These random numbers are generated once at initialization time and then used throughout the life time of the hash table.

3. The hash key for a position is the XOR of all the random numbers which are applicable for the position (white stones, black stones, and ko position).

11.2.2 Organization of the hash table

The hash table consists of 3 parts:

- An area which contains so called *Hash Nodes*. Each hash node contains:
 - A go position as defined above.
 - A computed hash value for the position
 - A pointer to Read Results (see below)
 - A pointer to another hash node.
- An area with so called Read Results. These are used to store which function was called in the go position, which string was under attack or to be defended, and the result of the reading.

Each Read Result contains:

- the function ID (an int between 0 and 255), the position of the string under attack and a depth value, which is used to determine how deep the search was when it was made, packed into one 32 bit integer.
- The result of the search (a numeric value) and a position to play to get the result packed into one 32 bit integer.
- A pointer to another Read Result.
- An array of pointers to hash nodes. This is the hash table proper.

When the hash table is created, these 3 areas are allocated using `malloc()`. When the hash table is populated, all contents are taken from the Hash nodes and the Read results. No further allocation is done and when all nodes or results are used, the hash table is full. Nothing is deleted from the hash table except when it is totally emptied, at which point it can be used again as if newly initialized.

When a function wants to use the hash table, it looks up the current position using `hashtable_search()`. If the position doesn't already exist there, it can be entered using

`hashtable_enter_position()`.

Once the function has a pointer to the hash node containing a function, it can search for a result of a previous search using `hashnode_search()`. If a result is found, it can be used, and if not, a new result can be entered after a search using `hashnode_new_result()`.

Hash nodes which hash to the same position in the hash table (collisions) form a simple linked list. Read results for the same position, created by different functions and different attacked or defended strings also form a linked list.

This is deemed sufficiently efficient for now, but the representation of collisions could be changed in the future. It is also not determined what the optimum sizes for the hash table, the number of positions and the number of results are.

11.2.3 Hash Structures

The basic hash structures are declared in 'engine/hash.h' and 'engine/cache.c'

```
typedef struct hashposition_t {
    Compacttype board[COMPACT_BOARD_SIZE];
    int          ko_pos;
} Hashposition;
```

Represents the board and optionally the location of a ko, which is an illegal move.

The player whose move is next is not recorded.

```
typedef struct {
    Hashvalue      hashval;
    Hashposition   hashpos;
} Hash_data;
```

Represents the return value of a function (`hashval`) and the board state (`hashpos`).

```
typedef struct read_result_t {
    unsigned int data1;
    unsigned int data2;

    struct read_result_t *next;
} Read_result;
```

The `data1` field packs into 32 bits the following fields:

```
komaster:  2 bits (EMPTY, BLACK, WHITE, or GRAY)
kom_pos  : 10 bits (allows MAX_BOARD up to 31)
routine  :  4 bits (currently 10 different choices)
str1     : 10 bits
stackp   :  5 bits
```

The `data2` field packs into 32 bits the following fields:

```
status :  2 bits (0 free, 1 open, 2 closed)
result1:  4 bits
result2:  4 bits
move   : 10 bits
str2   : 10 bits
```

The `komaster` and (`kom_pos`) field are documented in See [Section 11.4 \[Ko\]](#), [page 117](#).

When a new result node is created, 'status' is set to 1 'open'. This is then set to 2 'closed' when the result is entered. The main use for this is to identify open result nodes when the hashtable is partially cleared. Another potential use for this field is to identify repeated positions in the reading, in particular local double or triple kos.

```
typedef struct hashnode_t {
    Hash_data      key;
    Read_result   * results;
```

```

    struct hashnode_t * next;
} Hashnode;

```

The hash table consists of hash nodes. Each hash node consists of The hash value for the position it holds, the position itself and the actual information which is purpose of the table from the start.

There is also a pointer to another hash node which is used when the nodes are sorted into hash buckets (see below).

```

typedef struct hashtable {
    size_t      hashtablesize; /* Number of hash buckets */
    Hashnode   ** hashtable; /* Pointer to array of hashnode lists */

    int        num_nodes; /* Total number of hash nodes */
    Hashnode   * all_nodes; /* Pointer to all allocated hash nodes. */
    int        free_node; /* Index to next free node. */

    int        num_results; /* Total number of results */
    Read_result * all_results; /* Pointer to all allocated results. */
    int        free_result; /* Index to next free result. */
} Hashtable;

```

The hash table consists of three parts:

- The hash table proper: a number of hash buckets with collisions being handled by a linked list.
- The hash nodes. These are allocated at creation time and are never removed or reallocated in the current implementation.
- The results of the searches. Since many different searches can be done in the same position, there should be more of these than hash nodes.

11.3 Persistent Reading Cache

Some calculations can be safely saved from move to move. If the opponent's move is not close to our worm or dragon, we do not have to reconsider the life or death of that group on the next move. So the result is saved in a persistent cache. Persistent caches are used for are used in the engine for several types of read results.

- Tactical reading
- Owl reading
- Connection reading
- Breakin code

In this section we will discuss the persistent caching of tactical reading but the same principles apply to the other persistent caches.

Persistent caching is an important performance feature. However it can lead to mistakes and debugging problems—situations where GNU Go generates the right move during debugging but plays a wrong move during a game. If you suspect a persistent cache effect you may try loading the sgf file with the `--replay` option and see if the mistake is repeated (see [Section 3.9 \[Invoking GNU Go\], page 14](#)).

The function `store_persistent_cache()` is called only by `attack` and `find_defense`, never from their static recursive counterparts `do_attack` and `do_defend`. The function `store_persistent_reading_cache()` attempts to cache the most expensive reading results. The function `search_persistent_reading_cache` attempts to retrieve a result from the cache.

If all cache entries are occupied, we try to replace the least useful one. This is indicated by the score field, which is initially the number of nodes expended by this particular reading, and later multiplied by the number of times it has been retrieved from the cache.

Once a (permanent) move is made, a number of cache entries immediately become invalid. These are cleaned away by the function `purge_persistent_reading_cache()`. To have a criterion for when a result may be purged, the function `store_persistent_cache()` computes the *reading shadow* and *active area*. If a permanent move is subsequently played in the active area, the cached result is invalidated. We now explain this algorithm in detail.

The *reading shadow* is the concatenation of all moves in all variations, as well as locations where an illegal move has been tried.

Once the read is finished, the reading shadow is expanded to the *active area* which may be cached. The intention is that as long as no stones are played in the active area, the cached value may safely be used.

Here is the algorithm used to compute the active area. This algorithm is in the function `store_persistent_reading_cache()`. The most expensive readings so far are stored in the persistent cache.

- The reading shadow and the string under attack are marked with the character ‘1’. We also include the successful move, which is most often a part of the reading shadow, but sometimes not, for example with the function `attack1()`.
- Next the reading shadow is expanded by marking strings and empty vertices adjacent to the area marked ‘1’ with the character ‘2’.
- Next vertices adjacent to empty vertices marked ‘2’ are labelled with the character ‘3’.
- Next all vertices adjacent to previously marked vertices. These are marked ‘-1’ instead of the more logical ‘4’ because it is slightly faster to code this way.
- If the stack pointer is >0 we add the moves already played from the moves stack with mark 4.

11.4 Ko Handling

The principles of ko handling are the same for tactical reading and owl reading.

We have already mentioned (see [Section 11.1 \[Reading Basics\], page 111](#)) that GNU Go uses a return code of `KO_A` or `KO_B` if the result depends on ko. The return code of `KO_B` means that the position can be won provided the player whose move calls the function can come up with a sufficiently large ko threat. In order to verify this, the function must simulate making a ko threat and having it answered by taking the ko even if it is illegal. We call such an experimental taking of the ko a *conditional* ko capture.

Conditional ko captures are accomplished by the function `tryko()`. This function is like `trymove()` except that it does not require legality of the move in question.

The static reading functions, and the global functions `do_attack` and `do_find_defense` consult parameters `komaster`, `kom_pos`, which are declared static in ‘board.c’.

These mediate ko captures to prevent the occurrence of infinite loops. During reading, the komaster values are pushed and popped from a stack.

Normally `komaster` is `EMPTY` but it can also be `'BLACK'`, `'WHITE'`, `GRAY_BLACK`, `GRAY_WHITE` or `WEAK_KO`. The komaster is set to `color` when `color` makes a conditional ko capture. In this case `kom_pos` is set to the location of the captured ko stone.

If the opponent is komaster, the reading functions will not try to take the ko at `kom_pos`. Also, the komaster is normally not allowed to take another ko. The exception is a nested ko, characterized by the condition that the captured ko stone is at distance 1 both vertically and horizontally from `kom_pos`, which is the location of the last stone taken by the komaster. Thus in this situation:

```
.OX
OX*X
OmOX
OO
```

Here if `'m'` is the location of `kom_pos`, then the move at `'*'` is allowed.

The rationale behind this rule is that in the case where there are two kos on the board, the komaster cannot win both, and by becoming komaster he has already chosen which ko he wants to win. But in the case of a nested ko, taking one ko is a precondition to taking the other one, so we allow this.

If the komaster's opponent takes a ko, then both players have taken one ko. In this case `komaster` is set to `GRAY_BLACK` or `GRAY_WHITE` and after this further ko captures are even further restricted.

If the ko at `kom_pos` is filled, then the komaster reverts to `EMPTY`.

In detail, the komaster scheme is as follows. Color `'O'` is to move. This scheme is known as scheme 5 since in versions of GNU Go through 3.4, several different schemes were included.

- 1. Komaster is `EMPTY`.
 - 1a. Unconditional ko capture is allowed.
 - Komaster remains `EMPTY` if previous move was not a ko capture.
 - Komaster is set to `WEAK_KO` if previous move was a ko capture and `kom_pos` is set to the old value of `board_ko_pos`.
 - 1b) Conditional ko capture is allowed.
 - Komaster is set to `O` and `kom_pos` to the location of the ko, where a stone was just removed.
- 2. Komaster is `O`:
 - 2a) Only nested ko captures are allowed. `Kom_pos` is moved to the new removed stone.
 - 2b) If komaster fills the ko at `kom_pos` then komaster reverts to `EMPTY`.
- 3. Komaster is `X`:
 - Play at `kom_pos` is not allowed. Any other ko capture is allowed. If `O` takes another ko, komaster becomes `GRAY_X`.

- 4. Komaster is GRAY_O or GRAY_X:
 - Ko captures are not allowed. If the ko at kom_pos is filled then the komaster reverts to EMPTY.
- 5. Komaster is WEAK_KO:
 - 5a) After a non-ko move komaster reverts to EMPTY.
 - 5b) Unconditional ko capture is only allowed if it is nested ko capture.
 - Komaster is changed to WEAK_X and kom_pos to the old value of board_ko_pos.
 - 5c) Conditional ko capture is allowed according to the rules of 1b.

11.5 A Ko Example

To see the komaster scheme in action, consider this position from the file 'regressions/games/life_and_death/tripod9.sgf'. We recommend studying this example by examining the variation file produced by the command:

```
gnugo -l tripod9.sgf --decide-dragon C3 -o vars.sgf
```

In the lower left hand corner, there are kos at A2 and B4. Black is unconditionally dead because if W wins either ko there is nothing B can do.

```

8 . . . . . . . .
7 . . 0 . . . . .
6 . . 0 . . . . .
5 0 0 0 . . . . .
4 0 . 0 0 . . . .
3 X 0 X 0 0 0 0 .
2 . X X X 0 . . .
1 X 0 . . . . .
  A B C D E F G H

```

This is how the komaster scheme sees this. B (i.e. X) starts by taking the ko at B4. W replies by taking the ko at A1. The board looks like this:

```

8 . . . . . . . .
7 . . 0 . . . . .
6 . . 0 . . . . .
5 0 0 0 . . . . .
4 0 X 0 0 . . . .
3 X . X 0 0 0 0 .
2 0 X X X 0 . . .
1 . 0 . . . . .
  A B C D E F G H

```

Now any move except the ko recapture (currently illegal) at A1 loses for B, so B retakes the ko and becomes komaster. The board looks like this:

```

8 . . . . . komaster: BLACK
7 . . 0 . . . . kom_pos: A2
6 . . 0 . . . .
5 0 0 0 . . . .
4 0 X 0 0 . . . .
3 X . X 0 0 0 0 .
2 . X X X 0 . . .
1 X 0 . . . . .
  A B C D E F G H

```

W takes the ko at B3 after which the komaster is GRAY and ko recaptures are not allowed.

```

8 . . . . . komaster: GRAY
7 . . 0 . . . . kom_pos: B4
6 . . 0 . . . .
5 0 0 0 . . . .
4 0 . 0 0 . . . .
3 X 0 X 0 0 0 0 .
2 . X X X 0 . . .
1 X 0 . . . . .
  A B C D E F G H

```

Since B is not allowed any ko recaptures, there is nothing he can do and he is found dead. Thus the komaster scheme produces the correct result.

11.6 Another Ko Example

We now consider an example to show why the komaster is reset to EMPTY if the ko is resolved in the komaster's favor. This means that the ko is filled, or else that it becomes no longer a ko and it is illegal for the komaster's opponent to play there.

The position resulting under consideration is in the file 'regressions/games/ko5.sgf'. This is the position:

```

. . . . . 0 0 8
X X X . . . 0 . 7
X . X X . . 0 . 6
. X . X X X 0 0 5
X X . X . X 0 X 4
. 0 X 0 0 0 X . 3
0 0 X 0 . 0 X X 2
. 0 . X 0 X X . 1
F G H J K L M N

```

We recommend studying this example by examining the variation file produced by the command:

```
gnugo -l ko5.sgf --quiet --decide-string L1 -o vars.sgf
```

The correct resolution is that H1 attacks L1 unconditionally while K2 defends it with ko (code KO_A).

After Black (X) takes the ko at K3, white can do nothing but retake the ko conditionally, becoming komaster. B cannot do much, but in one variation he plays at K4 and W takes at H1. The following position results:

```

. . . . . 0 0 8
X X X . . . 0 . 7
X . X X . . 0 . 6
. X . X X X 0 0 5
X X . X X X 0 X 4
. 0 X 0 0 0 X . 3
0 0 X 0 . 0 X X 2
. 0 0 . 0 X X . 1
F G H J K L M N

```

Now it is important the '0' is no longer komaster. Were '0' still komaster, he could capture the ko at N3 and there would be no way to finish off B.

11.7 Alternate Komaster Schemes

The following alternate schemes have been proposed. It is assumed that '0' is the player about to move.

11.7.1 Essentially the 2.7.232 scheme.

- Komaster is EMPTY.
 - Unconditional ko capture is allowed. Komaster remains EMPTY.
 - Conditional ko capture is allowed. Komaster is set to O and `kom_pos` to the location of the ko, where a stone was just removed.
- Komaster is O:
 - Conditional ko capture is not allowed.
 - Unconditional ko capture is allowed. Komaster parameters unchanged.
- Komaster is X:
 - Conditional ko capture is not allowed.
 - Unconditional ko capture is allowed except for a move at `kom_pos`. Komaster parameters unchanged.

11.7.2 Revised 2.7.232 version

- Komaster is EMPTY.
 - Unconditional ko capture is allowed. Komaster remains EMPTY.
 - Conditional ko capture is allowed. Komaster is set to '0' and `kom_pos` to the location of the ko, where a stone was just removed.
- Komaster is '0':
 - Ko capture (both kinds) is allowed only if after playing the move, `is_ko(kom_pos, X)` returns false. In that case, `kom_pos` is updated to the new ko position, i.e. the stone captured by this move.

- Komaster is ‘X’:
 - Conditional ko capture is not allowed.
 - Unconditional ko capture is allowed except for a move at `kom_pos`. Komaster parameters unchanged.

11.8 Superstrings

A *superstring* is an extended string, where the extensions are through the following kinds of connections:

1. Solid connections (just like ordinary string).

```
OO
```

2. Diagonal connection or one space jump through an intersection where an opponent move would be suicide or self-atari.

```
...
O.O
XOX
X.X
```

3. Bamboo joint.

```
OO
..
OO
```

4. Diagonal connection where both adjacent intersections are empty.

```
.O
O.
```

5. Connection through adjacent or diagonal tactically captured stones. Connections of this type are omitted when the superstring code is called from ‘`reading.c`’, but included when the superstring code is called from ‘`owl.c`’.

Like a dragon, a superstring is an amalgamation of strings, but it is a much tighter organization of stones than a dragon, and its purpose is different. Superstrings are encountered already in the tactical reading because sometimes attacking or defending an element of the superstring is the best way to attack or defend a string. This is in contrast with dragons, which are ignored during tactical reading.

11.9 Debugging the reading code

The reading code searches for a path through the move tree to determine whether a string can be captured. We have a tool for investigating this with the ‘`--decidestring`’ option. This may be run with or without an output file.

Simply running

```
gnugo -t -l [input file name] -L [movenumber] --decidestring [location]
```

will run `attack()` to determine whether the string can be captured. If it can, it will also run `find_defense()` to determine whether or not it can be defended. It will give a count

of the number of variations read. The `-t` is necessary, or else GNU Go will not report its findings.

If we add `-o output file` GNU Go will produce an output file with all variations considered. The variations are numbered in comments.

This file of variations is not very useful without a way of navigating the source code. This is provided with the GDB source file, listed at the end. You can source this from GDB, or just make it your GDB init file.

If you are using GDB to debug GNU Go you may find it less confusing to compile without optimization. The optimization sometimes changes the order in which program steps are executed. For example, to compile `reading.c` without optimization, edit `engine/Makefile` to remove the string `-O2` from the file, touch `engine/reading.c` and make. Note that the Makefile is automatically generated and may get overwritten later.

If in the course of reading you need to analyze a result where a function gets its value by returning a cached position from the hashing code, rerun the example with the hashing turned off by the command line option `--hash 0`. You should get the same result. (If you do not, please send us a bug report.) Don't run `--hash 0` unless you have a good reason to, since it increases the number of variations.

With the source file given at the end of this document loaded, we can now navigate the variations. It is a good idea to use `cgoban` with a small `-fontHeight`, so that the variation window takes in a big picture. (You can resize the board.)

Suppose after perusing this file, we find that variation 17 is interesting and we would like to find out exactly what is going on here.

The macro `'jt n'` will jump to the `n`-th variation.

```
(gdb) set args -l [filename] -L [move number] --decidestring [location]
(gdb) tbreak main
(gdb) run
(gdb) jt 17
```

will then jump to the location in question.

Actually the attack variations and defense variations are numbered separately. (But `find_defense()` is only run if `attack()` succeeds, so the defense variations may or may not exist.) It is redundant to have to `tbreak main` each time. So there are two macros `avar` and `dvar`.

```
(gdb) avar 17
```

restarts the program, and jumps to the 17-th attack variation.

```
(gdb) dvar 17
```

jumps to the 17-th defense variation. Both variation sets are found in the same `sgf` file, though they are numbered separately.

Other commands defined in this file:

```
dump will print the move stack.
nv moves to the next variation
ascii i j converts (i,j) to ascii

#####
#####          .gdbinit file          #####
#####

# this command displays the stack

define dump
set dump_stack()
end

# display the name of the move in ascii

define ascii
set gprintf("%o%m\n", $arg0, $arg1)
end

# display the all information about a dragon

define dragon
set ascii_report_dragon("$arg0")
end

define worm
set ascii_report_worm("$arg0")
end

# move to the next variation

define nv
tbreak trymove
continue
finish
next
end

# move forward to a particular variation

define jt
while (count_variations < $arg0)
nv
end
```

```

nv
dump
end

# restart, jump to a particular attack variation

define avar
delete
tbreak sgffile_decidestring
run
tbreak attack
continue
jt $arg0
end

# restart, jump to a particular defense variation

define dvar
delete
tbreak sgffile_decidestring
run
tbreak attack
continue
finish
next 3
jt $arg0
end

```

11.10 Connection Reading

GNU Go does reading to determine if strings can be connected. The algorithms for this are in ‘readconnect.c’. As with the reading code, the connection code is not pattern based.

The connection code is invoked by the engine through the functions:

- `int string_connect(int str1, int str2, int *move)`
Returns WIN if `str1` and `str2` can be connected.
- `int disconnect(int str1, int str2, int *move)`
Returns WIN if `str1` and `str2` can be disconnected.

To see the connection code in action, you may try the following example.

```
gnugo --quiet -l connection3.sgf --decide-connection M3/N7 -o vars.sgf
```

(The file ‘connection3.sgf’ is in ‘regression/games’.) Examine the sgf file produced by this to see what kind of reading is done by the functions `string_connect()` and `string_disconnect()`, which are called by the function `decide_connection`.

One use of the connection code is used is through the autohelper macros `oplay_connect`, `xplay_connect`, `oplay_disconnect` and `xplay_disconnect` which are used in the connection databases.

12 Pattern Based Reading

In the tactical reading code in `'reading.c'`, the code generating the moves which are tried are all hand coded in C, for efficiency. There is much to be said for another type of reading, in which the moves to be tried are generated from a pattern database.

GNU Go does three main types of pattern based reading. First, there is the OWL code (Optics with Limit Negotiation) which attempts to read out to a point where the code in `'engine/optics.c'` (see [Chapter 8 \[Eyes\], page 60](#)) can be used to evaluate it. Like the tactical reading code, a persistent cache is employed to maintain some of the owl data from move to move. This is an essential speedup without which GNU Go would play too slowly.

Secondly, there is the `'engine/combination.c'` which attempts to find combinations—situations where a series of threats eventually culminates in one that cannot be parried.

Finally there is the `semeai` module. A `semeai` is a capturing race between two adjacent DEAD or CRITICAL dragons of opposite colors. The principal function, `owl_analyze_semeai()` is contained in `'owl.c'`. Due to the complex nature of semeais, the results of this function are more frequently wrong than the usual owl code.

12.1 The Owl Code

The life and death code in `'optics.c'`, described elsewhere (see [Chapter 8 \[Eyes\], page 60](#)), works reasonably well as long as the position is in a *terminal position*, which we define to be one where there are no moves left which can expand the eye space, or limit it. In situations where the dragon is surrounded, yet has room to thrash around a bit making eyes, a simple application of the graph-based analysis will not work. Instead, a bit of reading is needed to reach a terminal position.

The defender tries to expand his eyespace, the attacker to limit it, and when neither finds an effective move, the position is evaluated. We call this type of life and death reading *Optics With Limit-negotiation* (OWL). The module which implements it is in `'engine/owl.c'`.

There are two reasonably small databases `'patterns/owl_defendpats.db'` and `'patterns/owl_attackpats.db'` of expanding and limiting moves. The code in `'owl.c'` generates a small move tree, allowing the attacker only moves from `'owl_attackpats.db'`, and the defender only moves from `'owl_defendpats.db'`. In addition to the moves suggested by patterns, vital moves from the eye space analysis are also tested.

A third database, `'owl_vital_apats.db'` includes patterns which override the eyespace analysis done by the optics code. Since the eyeshape graphs ignore the complications of shortage of liberties and cutting points in the surrounding chains, the static analysis of eyespace is sometimes wrong. The problem is when the optics code says that a dragon definitely has 2 eyes, but it isn't true due to shortage of liberties, so the ordinary owl patterns never get into play. In such situations `'owl_vital_apats.db'` is the only available measure to correct mistakes by the optics. Currently the patterns in `'owl_vital_apats.db'` are only matched when the level is 9 or greater.

The owl code is tuned by editing these three pattern databases, principally the first two.

A node of the move tree is considered `terminal` if no further moves are found from `'owl_attackpats.db'` or `'owl_defendpats.db'`, or if the function `compute_eyes_pessimistic()` reports that the group is definitely alive. At this point, the status of the group is evaluated. The functions `owl_attack()` and `owl_defend()`, with usage similar to `attack()` and `find_defense()`, make use of the owl pattern databases to generate the move tree and decide the status of the group.

The function `compute_eyes_pessimistic()` used by the owl code is very conservative and only feels certain about eyes if the eyespace is completely closed (i.e. no marginal vertices).

The maximum number of moves tried at each node is limited by the parameter `MAX_MOVES` defined at the beginning of `'engine/owl.c'`. The most most valuable moves are tried first, with the following restrictions:

- If `stackp > owl_branch_depth` then only one move is tried per variation.
- If `stackp > owl_reading_depth` then the reading terminates, and the situation is declared a win for the defender (since deep reading may be a sign of escape).
- If the node count exceeds `owl_node_limit`, the reading also terminates with a win for the defender.
- Any pattern with value 99 is considered a forced move: no other move is tried, and if two such moves are found, the function returns false. This is only relevant for the attacker.
- Any pattern in `'patterns/owl_attackpats.db'` and `'patterns/owl_defendpats.db'` with value 100 is considered a win: if such a pattern is found by `owl_attack` or `owl_defend`, the function returns true. This feature must be used most carefully.

The functions `owl_attack()` and `owl_defend()` may, like `attack()` and `find_defense()`, return an attacking or defending move through their pointer arguments. If the position is already won, `owl_attack()` may or may not return an attacking move. If it finds no move of interest, it will return `PASS`, that is, 0. The same goes for `owl_defend()`.

When `owl_attack()` or `owl_defend()` is called, the dragon under attack is marked in the array `goal`. The stones of the dragon originally on the board are marked with `goal=1`; those added by `owl_defend()` are marked with `goal=2`. If all the original strings of the original dragon are captured, `owl_attack()` considers the dragon to be defeated, even if some stones added later can make a live group.

Only dragons with small escape route are studied when the functions are called from `make_dragons()`.

The owl code can be conveniently tested using the `'--decide-owl location'` option. This should be used with `'-t'` to produce a useful trace, `'-o'` to produce an SGF file of variations produced when the life and death of the dragon at `location` is checked, or both. `'--decide-position'` performs the same analysis for all dragons with small escape route.

12.2 Combination reading

It may happen that no single one of a set of worms can be killed, yet there is a move that guarantees that at least one can be captured. The simplest example is a double atari. The purpose of the code in `'combination.c'` is to find such moves.

For example, consider the following situation:

```

+-----
|...0000X
|...00XXX
|.0.OXX..
|.OX.OX..
|.OX..00..
|.XX000XO.
|..*XXOX..
|...XOX..
|.XX..X...
|X.....

```

Every ‘X’ stone in this position is alive. However the move at ‘*’ produces a position in which at least one of four strings will get captured. This is a *combination*.

The driving function is called `atari_atari` because typically a combination involves a sequence of ataris culminating in a capture, though sometimes the moves involved are not ataris. For example in the above example, the first move at ‘*’ is *not* an atari, though after ‘O’ defends the four stones above, a sequence of ataris ensues resulting in the capture of some string.

Like the owl functions `atari_atari` does pattern-based reading. The database generating the attacking moves is ‘`aa_attackpats.db`’. One danger with this function is that the first atari tried might be irrelevant to the actual combination. To detect this possibility, once we’ve found a combination, we mark that first move as forbidden, then try again. If no combination of the same size or larger turns up, then the first move was indeed essential.

- `void combinations(int color)`
Generate move reasons for combination attacks and defenses against them. This is one of the move generators called from `genmove()`.
- `int atari_atari(int color, int *attack_move, char defense_moves[BOARDMAX], int save_verbos)`
Look for a combination for `color`. For the purpose of the move generation, returns the size of the smallest of the worms under attack.
- `int atari_atari_confirm_safety(int color, int move, int *defense, int minsize, const char saved_dragons[BOARDMAX], const char saved_worms[BOARDMAX])`
Tries to determine whether a move is a blunder. Wrapper around `atari_atari_blunder_size`. Check whether a combination attack of size at least `minsize` appears after move at `move` has been made. The arrays `saved_dragons[]` and `saved_worms[]` should be one for stones belonging to dragons or worms respectively, which are supposedly saved by `move`.
- `int atari_atari_blunder_size(int color, int move, int *defense, const char safe_stones[BOARDMAX])`
This function checks whether any new combination attack appears after move at `(move)` has been made, and returns its size (in points). `safe_stones` marks which of our stones are supposedly safe after this move.

13 Influence Function

13.1 Conceptual Outline of Influence

We define call stones *lively* if they cannot be tactically attacked, or if they have a tactical defense and belong to the player whose turn it is. Similarly, stones that cannot be strategically attacked (in the sense of the life-and-death analysis), or that have a strategical defense and belong to the player to move, are called *alive*. If we want to use the influence function before deciding the strategical status, all lively stones count as alive.

Every alive stone on the board works as an influence source, with influence of its color radiating outwards in all directions. The strength of the influence declines exponentially with the distance from the source.

Influence can only flow unhindered if the board is empty, however. All lively stones (regardless of color) act as influence barriers, as do connections between enemy stones that can't be broken through. For example the one space jump counts as a barrier unless either of the stones can be captured. Notice that it doesn't matter much if the connection between the two stones can be broken, since in that case there would come influence from both directions anyway.

From the influence of both colors we compute a territorial value between -1.0 and +1.0 for each intersection, which can be seen as the likely hood of it becoming territory for either color.

In order to avoid finding bogus territory, we add extra influence sources at places where an invasion can be launched, e.g. at 3-3 under a handicap stone, in the middle of wide edge extensions and in the center of large open spaces anywhere. Similarly we add extra influence sources where intrusions can be made into what otherwise looks as solid territory, e.g. monkey jumps. These intrusions depend on whose turn we assume it to be.

All these extra influence sources, as well as connections, are controlled by a pattern database, which consists of the two files `patterns/influence.db` and `patterns/barriers.db`. The details are explained in [Section 13.12 \[Influential Patterns\]](#), page 141.

13.2 Territory, Moyo and Area

Using the influence code, empty regions of the board are partitioned in three ways. A vertex may be described as White or Black's *territory*, *moyo* or *area*. The functions `whose_territory()`, `whose_moyo()` and `whose_area()` will return a color, or EMPTY if it belongs to one player or the other in one of these classifications.

- Territory

Those parts of the board which are expected to materialize as actual points for one player or the other at the end of the game are considered *territory*.

- Moyo

Those parts of the board which are either already territory or more generally places where a territory can easily materialize if the opponent neglects to reduce are considered *moyo*. *moyo*.

- Area

Those parts of the board where one player or the other has a stronger influence than his opponent are considered *area*.

Generally territory is moyo and moyo is area. To get a feeling for these concepts, load an sgf file in a middle game position with the option ‘-m 0x0180’ and examine the resulting diagrams (see [Section 13.13 \[Influential Display\]](#), page 143).

13.3 Where influence gets used in the engine

The information obtained from the influence computation is used in a variety of places in the engine, and the influence module is called several times in the process of the move generation. The details of the influence computation vary according to the needs of the calling function.

After GNU Go has decided about the tactical stability of strings, the influence module gets called the first time. Here all lively stones act as an influence source of default strength 100. The result is stored in the variables `initial_influence` and `initial_opposite_influence`, and it is used as an important information for guessing the strength of dragons. For example, a dragon that is part of a moyo of size 25 is immediately considered alive. For dragons with a smaller moyo size, a life-and-death analysis will be done by the owl code (see [Chapter 12 \[Pattern Based Reading\]](#), page 126). A dragon with a moyo size of only 5 will be considered weak, even if the owl code has decided that it cannot be killed.

As a tool for both the owl code and the strength estimate of dragons, an "escape" influence gets computed for each dragon (see [Section 13.9 \[Escape\]](#), page 136).

Once all dragons have been evaluated, the influence module is called again and the variables `initial_influence` and `initial_opposite_influence` get overwritten. Of course, the dragon status', which are available now, are taken into account. Stones belonging to a dead dragon will not serve as an influence source, and the strengths of other stones get adjusted according to the strength of their respective dragon.

The result of this run is the most important tool for move evaluation. All helper functions of patterns as explained in [Chapter 9 \[Patterns\]](#), page 77 that refer to influence results (e. g. `olib(*)` etc.) actually use these results. Further, `initial_influence` serves as the reference for computing the territorial value of a move. That is, from the influence strengths stored in `initial_influence`, a territory value is assigned to each intersection. This value is supposed to estimate the likelihood that this intersection will become white or black territory.

Then, for each move that gets considered in the function `value_moves`, the influence module is called again via the function `compute_move_influence` to assess the likely territorial balance after this move, and the result is compared with the state before that move.

An additional influence computation is done in order to compute the followup value of a move. Some explanations are in [Section 13.5 \[Territorial Details\]](#), page 133.

Some of the public functions from ‘`influence.c`’ which are used throughout the engine are listed in [Section 18.4 \[Influence Utilities\]](#), page 178.

13.4 Influence and Territory

In this section we consider how the influence function is used to estimate territory in the function `estimate_territorial_value()`.

A move like ‘*’ by ‘O’ below is worth one point:

```
OXXX.
OX.XX
O*a.X
OX.XX
OXXX.
```

This is evaluated by the influence function in the following way: We first assign territory under the assumption that X moves first in all local positions in the original position; then we reassign territory, again under the assumption that ‘X’ moves first in all local positions, but after we let ‘O’ make the move at ‘*’. These two territory assignments are compared and the difference gives the territorial value of the move.

Technically, the assumption that ‘X’ plays first everywhere is implemented via an asymmetric pattern database in `barriers.db`. What exactly is a safe connection that stops hostile influence from passing through is different for ‘O’ and ‘X’; of course such a connection has to be tighter for stones with color ‘O’. Also, additional intrusion influence sources are added for ‘X’ in places where ‘X’ stones have natural followup moves.

In this specific example above, the asymmetry (before any move has been made) would turn out as follows: If ‘X’ is in turn to move, the white influence would get stopped by a barrier at ‘*’, leaving 4 points of territory for ‘X’. However, if ‘O’ was next to move, then a followup move for the white stones at the left would be assumed in the form of an extra ("intrusion") influence source at ‘*’. This would get stopped at ‘a’, leaving three points of territory.

Returning to the valuation of a move by ‘O’ at ‘*’, we get a value of 1 for the move at ‘*’. However, of course this move is sente once it is worth playing, and should therefore (in miai counting) be awarded an effective value of 2. Hence we need to recognize the followup value of a move. GNU Go 3.0 took care of this by using patterns in `patterns.db` that enforced an explicit followup value. Versions from 3.2 on instead compute a separate followup influence to each move considered. In the above example, an intrusion source will be added at ‘a’ as a followup move to ‘*’. This destroys all of Black’s territory and hence gives a followup value of 3.

The pattern based followup value are still needed at some places, however.

To give another example, consider this position where we want to estimate the value of an ‘O’ move at ‘*’:

```
000XXX
..OX..
..OX..
...*..
-----
```

Before the move we assume ‘X’ moves first in the local position (and that ‘O’ has to connect), which gives territory like this (lower case letter identify territory for each player):

```
000XXX
```

```

oo0Xxx
o.0Xxx
o...xx
-----

```

Then we let 'O' make the move at '*' and assume 'X' moves first again next. The territory then becomes ('X' is also assumed to have to connect):

```

000XXX
oo0Xxx
oo0X.x
oo.0.x
-----

```

We see that this makes a difference in territory of 4, which is what `influence_delta_territory()` should report. Then again, we have followup value, and here also a reverse followup value. The reverse followup value, which in this case will be so high that the move is treated as reverse sente, is added by an explicit pattern. Other sources for followup or reverse followup values are threats to capture a rescue a string of stones. See the code and comments in the function `value_move_reasons` for how followup and reverse followup values are used to adjust the effective move value.

To give an example of territorial value where something is captured, consider the 'O' move at '*' here,

```

XXXXXXXXO
X.0000XO
X.O..0*O
-----

```

As before we first let the influence function determine territory assuming X moves first, i.e. with a captured group:

```

XXXXXXXXO
XxyyyyXO
Xxyxxy.O
-----

```

Here 'y' indicates 'X' territory + captured stone, i.e. these count for two points. After the 'O' move at '*' we instead get

```

XXXXXXXXO
X.0000XO
X.Ooo000
-----

```

and we see that 'X' has 16 territory fewer and 'O' has two territory more, for a total difference of 18 points.

That the influence function counts the value of captured stones was introduced in GNU Go 3.2. Previously this was instead done using the `effective_size` heuristic. The effective size is the number of stones plus the surrounding empty spaces which are closer to this string or dragon than to any other stones. Here the 'O' string would thus have effective size 6 (number of stones) + 2 (interior eye) + 2*0.5 (the two empty vertices to the left of the string, split half each with the surrounding X string) + 1*0.33 (the connection point,

split between three strings) = 9.33. As noted this value was doubled, giving 18.67 which is reasonably close to the correct value of 18. The effective size heuristic is still used in certain parts of the move valuation where we can't easily get a more accurate value from the influence function (e. g. attacks depending on a ko, attack threats).

Note that this section only describes the territorial valuation of a move. Apart from that, GNU Go uses various heuristics in assigning a strategical value (weakening and strengthening of other stones on the board) to a move. Also, the influence function isn't quite as well tuned as the examples above may seem to claim. But it should give a fairly good idea of how the design is intended.

Another matter is that so far we have only considered the change in secure territory. GNU Go 3.2 and later versions use a revised heuristic, which is explained in the next section, to assign probable territory to each player.

13.5 Details of the Territory Valuation

This section explains how GNU Go assigns a territorial value to an intersection once the white and black influence have been computed. The intention is that an intersection that has a chance of xx% of becoming white territory is counted as 0.xx points of territory for white, and similar for black.

The algorithm in the function `new_value_territory` goes roughly as follows:

If `wi` is the white influence at a point, and `bi` the black influence, then `value = (wi-bi) / (wi+bi) ^ 3` (positive values indicates likley white territory, negative stand for black territory) turns out to be very simple first guess that is still far off, but reasonable enough to be useful.

This value is then suspect a number of corrections. Assume that this first guess resulted in a positive value.

If both `bi` and `wi` are small, it gets reduced. What exactly is "small" depends on whether the intersection is close to a corner or an edge of the board, since it is easier to claim territory in the corner than in the center.

Then the value at each intersection is degraded to the minimum value of its neighbors. This can be seen as a second implementation of the proverb saying that there is no territory in the center of the board. This step substantially reduces the size of spheres of territory that are open at several sides.

Finally, there are a number of patterns that explicitly forbid GNU Go to count territory at some intersections. This is used e. g. for false eyes that will eventually have to be filled in. Also, points for prisoners are added.

To fine tune this scheme, some revisions have been made to the influence computations that are relevant for territorial evaluation. This includes a reduced default attenuation and some revised pattern handling.

13.6 The Core of the Influence Function

The basic influence radiation process can efficiently be implemented as a breadth first search for adjacent and more distant points, using a queue structure.

Influence barriers can be found by pattern matching, assisted by reading through constraints and/or helpers. Wall structures, invasion points and intrusion points can be found by pattern matching as well.

When influence is computed, the basic idea is that there are a number of influence sources on the board, whose contributions are summed to produce the influence values. For the time being we can assume that the living stones on the board are the influence sources, although this is not the whole story.

The function `compute_influence()` contains a loop over the board, and for each influence source on the board, the function `accumulate_influence()` is called. This is the core of the influence function. Before we get into the details, this is how the influence field from a single isolated influence source of strength 100 turns out (with an attenuation of 3.0):

```

0 0 0 0 0 0 0 0 0 0 0
0 0 0 0 1 1 1 0 0 0 0
0 0 0 1 2 3 2 1 0 0 0
0 0 1 3 5 11 5 3 1 0 0
0 1 2 5 16 33 16 5 2 1 0
0 1 3 11 33 X 33 11 3 1 0
0 1 2 5 16 33 16 5 2 1 0
0 0 1 3 5 11 5 3 1 0 0
0 0 0 1 2 3 2 1 0 0 0
0 0 0 0 1 1 1 0 0 0 0
0 0 0 0 0 0 0 0 0 0 0

```

These values are in reality floating point numbers but have been rounded down to the nearest integer for presentation. This means that the influence field does not stop when the numbers become zeroes.

Internally `accumulate_influence()` starts at the influence source and spreads influence outwards by means of a breadth first propagation, implemented in the form of a queue. The order of propagation and the condition that influence only is spread outwards guarantee that no intersection is visited more than once and that the process terminates. In the example above, the intersections are visited in the following order:

```

+ + + + + + + + + +
+ 78 68 66 64 63 65 67 69 79 +
+ 62 46 38 36 35 37 39 47 75 +
+ 60 34 22 16 15 17 23 43 73 +
+ 58 32 14 6 3 7 19 41 71 +
+ 56 30 12 2 0 4 18 40 70 +
+ 57 31 13 5 1 8 20 42 72 +
+ 59 33 21 10 9 11 24 44 74 +
+ 61 45 28 26 25 27 29 48 76 +
+ 77 54 52 50 49 51 53 55 80 +
+ + + + + + + + + +

```

The visitation of intersections continues in the same way on the intersections marked '+' and further outwards. In a real position there will be stones and tight connections stopping the influence from spreading to certain intersections. This will disrupt the diagram

above, but the main property of the propagation still remains, i.e. no intersection is visited more than once and after being visited no more influence will be propagated to the intersection.

13.7 The Influence Algorithm

Let (m, n) be the coordinates of the influence source and (i, j) the coordinates of an intersection being visited during propagation, using the same notation as in the `accumulate_influence()` function. Influence is now propagated to its eight closest neighbors, including the diagonal ones, according to the follow scheme:

For each of the eight directions (di, dj) , do:

1. Compute the scalar product $di*(i-m) + dj*(j-n)$ between the vectors (di,dj) and $(i, j) - (m,n)$
2. If this is negative or zero, the direction is not outwards and we continue with the next direction. The exception is when we are visiting the influence source, i.e. the first intersection, when we spread influence in all directions anyway.
3. If $(i+di, j+dj)$ is outside the board or occupied we also continue with the next direction.
4. Let S be the strength of the influence at (i, j) . The influence propagated to $(i+di, j+dj)$ from this intersection is given by $P*(1/A)*D*S$, where the three different kinds of damping are:
 - The permeability 'P', which is a property of the board intersections. Normally this is one, i.e. unrestricted propagation, but to stop propagation through e.g. one step jumps, the permeability is set to zero at such intersections through pattern matching. This is further discussed below.
 - The attenuation 'A', which is a property of the influence source and different in different directions. By default this has the value 3 except diagonally where the number is twice as much. By modifying the attenuation value it is possible to obtain influence sources with a larger or a smaller effective range.
 - The directional damping 'D', which is the squared cosine of the angle between (di,dj) and $(i, j) - (m,n)$. The idea is to stop influence from "bending" around an interfering stone and get a continuous behavior at the right angle cutoff. The choice of the squared cosine for this purpose is rather arbitrary, but has the advantage that it can be expressed as a rational function of 'm', 'n', 'i', 'j', 'di', and 'dj', without involving any trigonometric or square root computations. When we are visiting the influence source we let by convention this factor be one.

Influence is typically contributed from up to three neighbors "between" this intersection and the influence source. These values are simply added together. As pointed out before, all contributions will automatically have been made before the intersection itself is visited.

When the total influence for the whole board is computed by `compute_influence()`, `accumulate_influence()` is called once for each influence source. These invocations are totally independent and the influence contributions from the different sources are added together.

13.8 Permeability

The permeability at the different points is initially one at all empty intersections and zero at occupied intersections. To get a useful influence function we need to modify this, however. Consider the following position:

```
|.....
|0000..
|...0..
|...a.X  ('a' empty intersection)
|...0..
|...000
|.....0
+-----
```

The corner is of course secure territory for '0' and clearly the 'X' stone has negligible effect inside this position. To stop 'X' influence from leaking into the corner we use pattern matching (pattern Barrier1/Barrier2 in 'barriers.db') to modify the permeability for 'X' at this intersection to zero. '0' can still spread influence through this connection.

Another case that needs to be mentioned is how the permeability damping is computed for diagonal influence radiation. For horizontal and vertical radiation we just use the permeability (for the relevant color) at the intersection we are radiating from. In the diagonal case we additionally multiply with the maximum permeability at the two intersections we are trying to squeeze between. The reason for this can be found in the diagram below:

```
|...X    |...X
|00..    |0da.
|..0.    |.bc.
|..0.    |..0.
+----- +-----
```

We don't want 'X' influence to be spread from 'a' to 'b', and since the permeability at both c and d is zero, the rule above stops this.

13.9 Escape

One application of the influence code is in computing the `dragon.escape_route` field. This is computed by the function `compute_escape()` as follows. First, every intersection is assigned an escape value, ranging between 0 and 4, depending on the influence value of the opposite color.

The `escape_route` field is modified by the code in 'surround.c' (see [Section 13.11 \[Surrounded Dragons\]](#), page 140). It is divided by two for weakly surrounded dragons, and set to zero for surrounded ones.

In addition to assigning an escape value to empty vertices, we also assign an escape value to friendly dragons. This value can range from 0 to 6 depending on the status of the dragon, with live dragons having value 6.

Then we sum the values of the resulting influence escape values over the intersections (including friendly dragons) at distance 4, that is, over those intersections which can be joined to the dragon by a path of length 4 (and no shorter path) not passing adjacent to

possibilities aren't overestimated. After we have made a move in the escape direction it is after all the opponent's turn.

The current escape route mechanism seems good enough to be useful but is not completely reliable. Mostly it seems to err on the side of being too optimistic.

13.10 Break Ins

The code in `'breakin.c'` break-ins into territories that require deeper tactical reading and are thus impossible to detect for the influence module. It gets run after the influence module and revises its territory valuations.

The break-in code makes use of two public functions in `'readconnect.c'`,

- `int break_in(int str, const char goal[BOARDMAX], int *move)`
Returns WIN if `str` can connect to the area `goal[]` (which may or may not contain stones), if the string's owner gets the first move.
- `int block_off(int str, const char goal[BOARDMAX], int *move)`
Returns WIN if `str` cannot connect to the area `goal[]` (which may or may not contain stones), if the other color moves first.

These functions are public front ends to their counterparts `recursive_break_in` and `recursive_block_off`, which call each other recursively.

The procedure is as follows: We look at all big (≥ 10) territory regions as detected by the influence code. Using the computation of connection distances from `readconnect.c`, we compute all nearby vertices of this territory. We look for the closest safe stones belonging to the opponent.

For each such string `str` we call

- `break_in(str, territory)` if the opponent is assumed to be next to move,
- `block_off(str, territory)` if the territory owner is next.

If the break in is successful resp. the blocking unsuccessful, we shrink the territory, and see whether the opponent can still break in. We repeat this until the territory is shrunk so much that the opponent can no longer reach it.

To see the break in code in action run GNU Go on the file `'regression/games/break_in.sgf'` with the option `-d0x102000`. Among the traces you will find:

```

Trying to break in from D7 to:
E9 (1) F9 (1) G9 (1) E8 (1) F8 (1) G8 (1)
H8 (1) G7 (1) H7 (1) J7 (1) H6 (1) J6 (1)
H5 (1) J5 (1) H4 (1) J4 (1) H3 (1) J3 (1)
H2 (1) J2 (1)
block_off D7, result 0 PASS (355, 41952 nodes, 0.73 seconds)
E9 (1) F9 (1) G9 (1) E8 (1) F8 (1) G8 (1)
H8 (1) G7 (1) H7 (1) J7 (1) H6 (1) J6 (1)
H5 (1) J5 (1) H4 (1) J4 (1) H3 (1) J3 (1)
H2 (1) J2 (1)
B:F4
Erasing territory at E8 -b.
Erasing territory at G3 -b.
```

Now trying to break to smaller goal:

```
F9 (1) G9 (1) F8 (1) G8 (1) H8 (1) G7 (1)
H7 (1) J7 (1) H6 (1) J6 (1) H5 (1) J5 (1)
H4 (1) J4 (1) H3 (1) J3 (1) H2 (1) J2 (1)
```

This means that the function `break_in` is called with the goal marked 'a' in the following diagram. The code attempts to find out whether it is possible to connect into this area from the string at D7.

```
  A B C D E F G H J
9 . . . . a a a . . 9
8 . . . . a a a a . 8
7 . . . X 0 0 a a a 7
6 . . . X X X 0 a a 6
5 . . . . + . . a a 5
4 . . . X . . 0 a a 4
3 . . . . X . . a a 3
2 . . . . . . 0 a a 2
1 . . . . . . . . . 1
  A B C D E F G H J
```

A breakin is found, so the goal is shrunk by removing E9 and J2, then `break_in` is called again.

In order to see what reading is actually done in order to do this break in, you may load GNU Go in gtp mode, then issue the commands:

```
loadsgf break_in.sgf
= black

start_sgftrace
=

break_in D7 E9 F9 G9 E8 F8 G8 H8 G7 H7 J7 H6 J6 H5 J5 H4 J4 H3 J3 H2 J2
= 1 E8

finish_sgftrace vars.sgf
=

start_sgftrace
=

break_in D7 F9 G9 F8 G8 H8 G7 H7 J7 H6 J6 H5 J5 H4 J4 H3 J3 H2 J2
= 1 G7

finish_sgftrace vars1.sgf
```

This will produce two sgf files containing the variations caused by these calls to the `breakin` code. The second file, 'vars1.sgf' will contain quite a few variations.

The `break_in` code makes a list of break ins which are found. When it is finished, the function `add_expand_territory_move` is called for each break in, adding a move reason.

The break in code is slow, and only changes a few moves by the engine per game. Nevertheless we believe that it contributes substantially to the strength of the program. The break in code is enabled by default in GNU Go 3.6 at level 10, and disabled at level 9. In fact, this is the **only** difference between levels 9 and 10 in GNU Go 3.6.

13.11 Surrounded Dragons

When is a dragon surrounded?

As has been pointed out by Bruce Wilcox, the geometric lines connecting groups of the opposite color are often important. It is very hard to prevent the escape of this ‘0’ dragon:

```

.....
.....0....
.X.....X
.X...0...X
.....
.....
-----

```

On the other hand, this dragon is in grave danger:

```

.....
.....
.X.....X
.....0....
.X.....X
.X...0...X
.....
.....
-----

```

The difference between these two positions is that in the first, the ‘0’ dragon crosses the line connecting the top two ‘X’ stones.

Code in ‘`surround.c`’ implements a test for when a dragon is surrounded. The idea is to compute the convex hull of the *surround set*, that is, the set stones belonging to unfriendly neighbor dragons. If the dragon is contained within that hull. If it is, it is said to be *surrounded*.

In practice this scheme is modified slightly. The implementation uses various algorithms to compute distances and hostile stones are discarded from the surround set when a pair other hostile ones can be found which makes the considered one useless. For example, in the following position the bottom ‘0’ stone would get discarded.

```

0.X.0
.....
.0.0.
.....
..0..

```

Also, points are added to the surround set below stones on the second and third lines. This should account for the edge being a natural barrier.

In order to compute distances between corners of the convex hull a sorting by angle algorithm has been implemented. If the distance between a pair enclosing stones is large, the surround status gets decreased to `WEAKLY_SURROUNDED`, or even 0 for very large ones.

The sorting by angle must be explained. A small diagram will probably help :

```
.0.0.
0...0
..X..
0...0
.0.0.
```

The sorting algorithm will generate this:

```
.4.5.
3...6
..X..
2...7
.1.8.
```

That is, the points are sorted by ascending order of the measure of the angle S-G-O, where S is SOUTH, G the (approximated) gravity center of the goal, and O the position of the considered hostile stones.

The necessity of such sorting appears when one tries to measure distances between enclosing stones without sorting them, just by using directly the existing left and right corners arrays. In some positions, the results will be inconsistent. Imagine, for example a position where for instance the points 1,2,3,4,6 and 7 were in the left array, leaving only 5 and 8 in the right array. Because of the large distance between 5 and 8, the dragon would have declared weak surrounded or not surrounded at all. Such cases are rare but frequent enough to require the angle sorting.

The following position:

```
0.X.0
.....
.0.0.
```

This is "more" surrounded than the following position:

```
0.XXXXXX.0
.....
.0.....0.
```

In the second case, the surround status would be lowered to `WEAKLY_SURROUNDED`.

The surround code is used to modify the `escape_route` field in the `dragon2` data array. When a dragon is `WEAKLY_SURROUNDED`, the `escape_route` is divided by 2. If the dragon is `SURROUNDED`, `escape_route` is simply set to 0.

13.12 Patterns used by the Influence module

This section explains the details of the pattern databases used for the influence computation.

First, we have the patterns in `'influence.db'`, which get matched symmetrically for both colors.

- ‘E’

These patterns add extra influence sources close to some shapes like walls. This tries to reflect their extra strength. These patterns are not used in the influence computations relevant for territory valuations, but they are useful for getting a better estimate of strengths of groups.

- ‘I’

These patterns add extra influence sources at typical invasion points. Usually they are of small strength. If they additionally have the class ‘s’, the extra influence source is added for both colors. Otherwise, only the player assumed to be next to move gets the benefit.

The patterns in ‘barriers.db’ get matched only for ‘O’ being the player next to move.

- ‘A’

Connections between ‘X’ stones that stop influence of ‘O’. They have to be tight enough that ‘O’ cannot break through, even though he is allowed to move first.

- ‘D’

Connections between ‘O’ stones that stop influence of ‘X’. The stones involved can be more loosely connected than those in ‘A’ patterns.

- ‘B’

These indicate positions of followup moves for the ‘O’ stone marked with ‘Q’ in the pattern. They are used to reduce the territory e. g. where a monkey jump is possible. Also, they are used in the computation of the followup influence, if the ‘Q’ stone was the move played (or a stone saved by the move played).

- ‘t’

These patterns indicate intersections where one color will not be able to get territory, for example in a false eye. The points are set with a call to the helper `non_territory` or `non_xterritory` in the action of the pattern.

The intrusion patterns (‘B’) are more powerful than the description above might suggest. They can be very helpful in identifying weak shapes (by adding an intrusion source for the opponent where he can break through). A negative inference for this is that a single bad ‘B’ pattern, e. g. one that has a wrong constraint, typically causes 5 to 10 FAILs in the regression test suite.

Influence Patterns can have autohelper constraints as usual. As for the constraint attributes, there are (additionally to the usual ones ‘O’, ‘o’, ‘X’ and ‘x’), attributes ‘Y’ and ‘FY’. A pattern marked with ‘Y’ will only be used in the influence computations relevant for the territory valuation, while ‘FY’ patterns only get used in the other influence computations.

The action of an influence pattern is at the moment only used for non-territory patterns as mentioned above, and as a workaround for a problem with ‘B’ patterns in the followup influence.

To see why this workaround is necessary, consider the following situation:

```

..XXX
.a*.0
.X.0.
..XX0

```

(Imagine that there is ‘X’ territory on the left.)

The move by ‘0’ at ‘*’ has a natural followup move at ‘a’. So, in the computation of the followup influence for ‘*’, there would be an extra influence source for ‘0’ at ‘a’ which would destroy a lot of black territory on the left. This would give a big followup value, and in effect the move ‘*’ would be treated as sente.

But of course it is gote, since ‘X’ will answer at ‘a’, which both stops the possible intrusion and threatens to capture ‘*’. This situation is in fact quite common.

Hence we need an additional constraint that can tell when an intrusion pattern can be used in followup influence. This is done by misusing the action line: An additional line

```
>return <condition>;
```

gets added to the pattern. The `condition` should be true if the intrusion cannot be stopped in sente. In the above example, the relevant intrusion pattern will have an action line of the form

```
>return (!xplay_attack(a,b));
```

where ‘b’ refers to the stone at ‘*’. In fact, almost all followup-specific constraints look similar to this.

13.13 Colored display and debugging of influence

There are various ways to obtain detailed information about the influence computations. Colored diagrams showing influence are possible from a colored xterm or rxvt window.

There are two options controlling when to generate diagrams:

- ‘-m 0x08’ or ‘-m 8’

Show diagrams for the initial influence computation. This is done twice, the first time before `make_dragons()` is run and the second time after. The difference is that dead dragons are taken into account the second time. Tactically captured worms are taken into account both times.

- ‘--debug-influence *location*’

Show influence diagrams after the move at the given location. An important limitation of this option is that it’s only effective for moves that the move generation is considering.

The other options control which diagrams should be generated in these situations. You have to specify at least one of the options above and at least one of the options below to generate any output.

The options below must be combined with one of the two previous ones, or the diagram will not be printed. For example to print the influence diagram, you may combine 0x08 and 0x010, and use the option ‘-m 0x018’.

- ‘-m 0x010’ or ‘-m 16’

Show colored display of territory/moyo/area regions.

- territory: cyan
- moyo: yellow
- area: red

This feature is very useful to get an immediate impression of the influence regions as GNU Go sees them.

- ‘-m 0x20’ or ‘-m 32’

Show numerical influence values for white and black. These come in two separate diagrams, the first one for white, the second one for black. Notice that the influence values are represented by floats and thus have been rounded in these diagrams.

- ‘-m 0x40’ or ‘-m 64’

This generates two diagrams showing the permeability for black and white influence on the board.

- ‘-m 0x80’ or ‘-m 128’

This shows the strength of the influence sources for black and white across the board. You will see sources at each lively stone (with strength depending on the strength of this stone), and sources contributed by patterns.

- ‘-m 0x100’ or ‘-m 256’

This shows the attenuation with which the influence sources spread influence across the board. Low attenuation indicates far-reaching influence sources.

- ‘-m 0x200’ or ‘-m 512’

This shows the territory valuation of GNU Go. Each intersection is shown with a value between -1.0 and +1.0 (or -2 resp. +2 if there is a dead stone on this intersection). Positive values indicate territory for white. A value of -0.5 thus indicates a point where black has a 50% chance of getting territory.

Finally, there is the debug option ‘-d 0x1’ which turns on on `DEBUG_INFLUENCE`. This gives a message for each influence pattern that gets matched. Unfortunately, these are way too many messages making it tedious to navigate the output. However, if you discover an influence source with ‘-m 0x80’ that looks wrong, the debug output can help you to quickly find out the responsible pattern.

13.14 Influence Tuning with `view.pike`

A useful program in the regression directory is `view.pike`. To run it, you need Pike, which you may download from <http://pike.ida.liu.se/>.

The test case ‘endgame:920’ fails in GNU Go 3.6. We will explain how to fix it.

Start by firing up `view.pike` on testcase `endgame:920`, e.g. by running `pike view.pike endgame:920` in the regression directory.

We see from the first view of move values that filling dame at P15 is valued highest with 0.17 points while the correct move at C4 is valued slightly lower with 0.16. The real problem is of course that C4 is worth a full point and thus should be valued about 1.0.

Now click on C4 to get a list of move reasons and move valuation information. Everything looks okay except that change in territory is 0.00 rather than 1.00 as it ought to be.

We can confirm this by choosing the “delta territory for...” button and again clicking C4. Now B5 should have been marked as one point of change in territory, but it’s not.

Next step is to enter the influence debug tool. Press the “influence” button, followed by “black influence, dragons known,” and “territory value.” This shows the expected territory if black locally moves first everywhere (thus “black influence”). Here we can see that B5 is incorrectly considered as 1.0 points of white territory.

We can compare this with the territory after a white move at C4 (still assuming that black locally moves first everywhere after that) by pressing “after move influence for...” and clicking C4. This looks identical, as expected since delta territory was 0, but here it is correct that B5 is 1.0 points of territory for white.

The most straightforward solution to this problem is to add a non-territory pattern, saying that white can’t get territory on B5 if black moves first. The nonterritory patterns are in ‘barriers.db’.

```
Pattern Nonterritory56

...
X.O
?0.

:8,t

eac
Xb0
?0d

;oplay_attack(a,b,c,d,d)

>non_xterritory(e);
```

In these patterns it’s always assumed that ‘O’ moves first and thus it says that ‘X’ can’t get territory at B5 (‘e’ in the pattern). Now we need to be a bit careful however since after ‘O’ plays at ‘a’ and ‘X’ cuts in at ‘b’, it may well happen that ‘O’ needs to defend around ‘d’, allowing ‘X’ to cut at ‘c’, possibly making the nonterritory assumption invalid. It’s difficult to do this entirely accurate, but the constraint above is fairly conservative and should guarantee that ‘a’ is safe in most, although not all, cases.

14 Monte Carlo Go

In Monte Carlo Go the engine plays random games to the end, generating moves from a pattern database within the context of the algorithm UCT (upper confidence bounds applied to trees). This algorithm allowed the program MoGo (<http://www.lri.fr/~gelly/MoGo.htm>, to become the first computer program to defeat a professional while taking a 9 stone handicap (<http://senseis.xmp.net/?MoGo>).

GNU Go 3.8 can play 9x9 Go with the option ‘--monte-carlo’ using the UCT algorithm. For command line options, see See [Section 3.9 \[Invoking GNU Go\], page 14](#).

During reading, the engine makes incremental updates of local 3x3 neighborhood, suicide status, self-atari status, and number of stones captured, for each move.

GNU Go’s simulations (Monte Carlo games) are pattern generated. The random playout move generation is distributed strictly proportional to move values computed by table lookup from a local context consisting of 3x3 neighborhood, opponent suicide status, own and opponent self-atari status, number of stones captured by own and opponent move, and closeness to the previous move. Let’s call this local context simply "a pattern" and the table "pattern values" or simply "patterns".

There are three built-in databases that you can select using the option ‘--mc-patterns <name>’, where ‘<name>’ is one of

- mc_montegnu_classic
- mc_mogo_classic
- mc_uniform

The first of these is an approximation of the previous random move generation algorithm. The mogo_classic pattern values is an approximation of the simulation policy used by early versions of MoGo, as published in the report [odification of UCT with Patterns in Monte-Carlo Go RR-6062](#), by Sylvain Gelly, Yizao Wang, Rmi Munos, and Olivier Teytaud. The uniform pattern values is the so called "light" playout which chooses uniformly between all legal moves except single point proper eyes.

If you’re not satisfied with these you can also tune your own pattern values with a pattern database file and load it at runtime with ‘--mc-load-patterns <name>’ adding your own pattern database.

Let’s start with the uniform pattern values. Those are defined by the file ‘patterns/mc_uniform.db’, which looks like this:

```
oOo
O*O
oO?

:O

oOo
O*O
---
```

```
:0
|0o
|*0
+--
```

```
:0
```

Patterns are always exactly 3x3 in size with the move at the center point. The symbols are the usual for GNU Go pattern databases:

```
* move
0 own stone (i.e. the same color as the color to move)
o own stone or empty
X opponent stone
x opponent stone or empty
? own stone, opponent stone, or empty
| vertical edge
- horizontal edge
+ corner
```

There's also a new symbol:

```
% own stone, opponent stone, empty, or edge
```

After the pattern comes a line starting with a colon. In all these patterns it says that the pattern has a move value of 0, i.e. must not be played. Unmatched patterns have a default value of 1. When all move values are zero for both players, the playout will stop. Including the three patterns above is important because otherwise the playouts would be likely to go on indefinitely, or as it actually happens be terminated at a hard-coded limit of 600 moves. Also place these patterns at the top of the database because when multiple patterns match, the first one is used, regardless of the values.

When using only these patterns you will probably notice that it plays rather heavy, trying hard to be solidly connected. This is because uniform playouts are badly biased with a high probability of non-solid connections being cut apart. To counter this you could try a pattern like

```
?X?
0*0
x.?
```

```
:20,near
```

to increase the probability that the one-point jump is reinforced when threatened. Here we added the property "near", which means that the pattern only applies if the previous move was played "near" this move. Primarily "near" means within the surrounding 3x3 neighborhood but it also includes certain cases of liberties of low-liberty strings adjacent to the previous move, e.g. the move to extend out of an atari created by the previous move. You have to read the source to find out the exact rules for nearness.

We could also be even more specific and say

```
?X?
0*0
```

x.?

```
:20,near,osafe,xsafe
```

to exclude the cases where this move is a self atari (osafe) or would be a self-atari for the opponent (xsafe).

It may also be interesting to see the effect of capturing stones. A catch-all pattern for captures would be

```
?X%
```

```
?*%
```

```
%%%
```

```
:10,ocap1,osafe
```

```
:20,ocap2
```

```
:30,ocap3
```

where we have used multiple colon lines to specify different move values depending on the number of captured stones; value 10 for a single captured stone, value 20 for two captured stones, and value 30 for three or more captured stones. Here we also excluded self-atari moves in the case of 1 captured stone in order to avoid getting stuck in triple-ko in the playouts (there's no superko detection in the playouts).

The full set of pattern properties is as follows:

<code>near</code>	The move is "near" the previous move.
<code>far</code>	The move is not "near" the previous move.
<code>osafe</code>	The move is not a self-atari.
<code>ounsafe</code>	The move is a self-atari.
<code>xsafe</code>	The move would not be a self-atari for the opponent.
<code>xunsafe</code>	The move would be a self-atari for the opponent.
<code>xsuicide</code>	The move would be suicide for the opponent
<code>xnosuicide</code>	The move would not be suicide for the opponent.
<code>ocap0</code>	The move captures zero stones.
<code>ocap1</code>	The move captures one stone.
<code>ocap2</code>	The move captures two stones.
<code>ocap3</code>	The move captures three or more stones.
<code>ocap1+</code>	The move captures one or more stones.
<code>ocap1-</code>	The move captures at most one stone.
<code>ocap2+</code>	The move captures two or more stones.
<code>ocap2-</code>	The move captures at most two stones.
<code>xcap0</code>	An opponent move would capture zero stones.

<code>xcap1</code>	An opponent move would capture one stone.
<code>xcap2</code>	An opponent move would capture two stones.
<code>xcap3</code>	An opponent move would capture three or more stones.
<code>xcap1+</code>	An opponent move would capture one or more stones.
<code>xcap1-</code>	An opponent move would capture at most one stone.
<code>xcap2+</code>	An opponent move would capture two or more stones.
<code>xcap2-</code>	An opponent move would capture at most two stones.

These can be combined arbitrarily but all must be satisfied for the pattern to take effect. If contradictory properties are combined, the pattern will never match.

14.1 Final Remarks

- Move values are unsigned 32-bit integers. To avoid overflow in computations it is highly recommended to keep the values below 10000000 or so.
- There is no speed penalty for having lots of patterns in the database. The average time per move is approximately constant (slightly dependent on how often stones are captured or become low on liberties) and the time per game mostly depends on the average game length.
- For more complex pattern databases, see `'patterns/mc_montegnu_classic.db'` and `'patterns/mc_mogo_classic.db'`.

Nobody really knows how to tune the random playouts to get as strong engine as possible. Please play with this and report any interesting findings, especially if you're able to make it substantially stronger than the `'montegnu_classic'` patterns.

15 The Board Library

The foundation of the GNU Go engine is a library of very efficient routines for handling go boards. This board library, called ‘libboard’, can be used for those programs that only need a basic go board but no AI capability. One such program is ‘patterns/joseki.c’, which compiles joseki pattern databases from SGF files.

If you want to use the board library in your own program, you need all the .c-files listed under libboard_SOURCES in engine/Makefile.am, and the files in the directories sgf/ and utils/. Then you should include engine/board.h in your code.

The library consists of the following files:

- ‘board.h’
The public interface to the board library.
- ‘board.c’
The basic board code. It uses incremental algorithms for keeping track of strings and liberties on the go board.
- ‘boardlib.c’
This contains all global variable of the board library.
- ‘hash.c’
Code for hashing go positions.
- ‘sgffile.c’
Implementation of output file in SGF format.
- ‘printutils.c’
Utilities for printing go boards and other things.

To use the board library, you must include ‘liberty.h’ just like when you use the whole engine, but of course you cannot use all the functions declared in it, i.e. the functions that are part of the engine, but not part of the board library. You must link your application with libboard.a.

15.1 Board Data structures

The basic data structures of the board correspond tightly to the `board_state` struct described in See [Section 17.3 \[The Board State\], page 163](#). They are all stored in global variables for efficiency reasons, the most important of which are:

```

int          board_size;
Intersection board[MAXSIZE];
int          board_ko_pos;

float        komi;
int          white_captured;
int          black_captured;

Hash_data    hashdata;
```

The description of the `Position` struct is applicable to these variables also, so we won't duplicate it here. All these variables are globals for performance reasons. Behind these variables, there are a number of other private data structures. These implement incremental handling of strings, liberties and other properties (see [Section 15.3 \[Incremental Board\]](#), page 153). The variable `hashdata` contains information about the hash value for the current position (see [Section 11.2 \[Hashing\]](#), page 113).

These variables should never be manipulated directly, since they are only the front end for the incremental machinery. They can be read, but should only be written by using the functions described in the next section. If you write directly to them, the incremental data structures will become out of sync with each other, and a crash is the likely result.

15.2 The Board Array

GNU Go represents the board in a one-dimensional array called `board`. For some purposes a two dimensional indexing of the board by parameters (i, j) might be used.

The `board` array includes out-of-board markers around the board. To make the relation to the old two-dimensional board representation clear, this figure shows how the 1D indices correspond to the 2D indices when `MAX_BOARD` is 7.

j	-1	0	1	2	3	4	5	6	
i	+-----								
-1	0	1	2	3	4	5	6	7	
0	8	9	10	11	12	13	14	15	
1	16	17	18	19	20	21	22	23	
2	24	25	26	27	28	29	30	31	
3	32	33	34	35	36	37	38	39	
4	40	41	42	43	44	45	46	47	
5	48	49	50	51	52	53	54	55	
6	56	57	58	59	60	61	62	63	
7	64	65	66	67	68	69	70	71	72

To convert between a 1D index `pos` and a 2D index (i, j) , the macros `POS`, `I`, and `J` are provided, defined as below:

```
#define POS(i, j)    ((MAX_BOARD + 2) + (i) * (MAX_BOARD + 1) + (j))
#define I(pos)      ((pos) / (MAX_BOARD + 1) - 1)
#define J(pos)      ((pos) % (MAX_BOARD + 1) - 1)
```

All 1D indices not corresponding to points on the board have the out of board marker value `GRAY`. Thus if `board_size` and `MAX_BOARD` both are 7, this looks like

```

      j  -1  0  1  2  3  4  5  6
i  +-----+
-1|  #  #  #  #  #  #  #  #
 0|  #  .  .  .  .  .  .  .
 1|  #  .  .  .  .  .  .  .
 2|  #  .  .  .  .  .  .  .
 3|  #  .  .  .  .  .  .  .
 4|  #  .  .  .  .  .  .  .
 5|  #  .  .  .  .  .  .  .
 6|  #  .  .  .  .  .  .  .
 7|  #  #  #  #  #  #  #  #  #

```

The indices marked ‘#’ have value GRAY. If MAX_BOARD is 7 and board_size is only 5:

```

      j  -1  0  1  2  3  4  5  6
i  +-----+
-1|  #  #  #  #  #  #  #  #
 0|  #  .  .  .  .  .  #  #
 1|  #  .  .  .  .  .  #  #
 2|  #  .  .  .  .  .  #  #
 3|  #  .  .  .  .  .  #  #
 4|  #  .  .  .  .  .  #  #
 5|  #  #  #  #  #  #  #  #
 6|  #  #  #  #  #  #  #  #
 7|  #  #  #  #  #  #  #  #  #

```

Navigation on the board is done by the SOUTH, WEST, NORTH, and EAST macros,

```

#define NS          (MAX_BOARD + 1)
#define WE          1
#define SOUTH(pos)  ((pos) + NS)
#define WEST(pos)   ((pos) - 1)
#define NORTH(pos)  ((pos) - NS)
#define EAST(pos)   ((pos) + 1)

```

There are also shorthand macros SW, NW, NE, SE, SS, WW, NN, EE for two step movements.

Any movement from a point on the board to an adjacent or diagonal vertex is guaranteed to produce a valid index into the board array, and the color found is GRAY if it is not on the board. To do explicit tests for out of board there are two macros

```

#define ON_BOARD(pos) (board[pos] != GRAY)
#define ON_BOARD1(pos) (((unsigned) (pos) < BOARDSIZE) && board[pos] != GRAY)

```

where the first one should be used in the algorithms and the second one is useful for assertion tests.

The advantage of a one-dimensional board array is that it gives a significant performance advantage. We need only one variable to determine a board position, which means that many functions need less arguments. Also, often one computation is sufficient for 1D-coordinate where we would need two with two 2D-coordinates: If we, for example, want

to have the coordinate of the upper right of `pos`, we can do this with `NORTH(EAST(pos))` instead of `(i+1, j-1)`.

Important: The 2D coordinate `(-1,-1)`, which is used for pass and sometimes to indicate no point, maps to the 1D coordinate 0, not to `-1`. Instead of a plain 0, use one of the macros `NO_MOVE` or `PASS_MOVE`.

A loop over multiple directions is straightforwardly written:

```
for (k = 0; k < 4; k++) {
    int d = delta[k];
    do_something(pos + d);
}
```

The following constants are useful for loops over the entire board and allocation of arrays with a 1-1 mapping to the board.

```
#define BOARD_SIZE ((MAX_BOARD + 2) * (MAX_BOARD + 1) + 1)
#define BOARD_MIN (MAX_BOARD + 2)
#define BOARD_MAX (MAX_BOARD + 1) * (MAX_BOARD + 1)
```

`BOARD_SIZE` is the actual size of the 1D board array, `BOARD_MIN` is the first index corresponding to a point on the board, and `BOARD_MAX` is one larger than the last index corresponding to a point on the board.

Often one wants to traverse the board, carrying out some function at every vertex. Here are two possible ways of doing this:

```
int m, n;
for (m = 0; m < board_size; m++)
    for (n = 0; n < board_size; n++) {
        do_something(POS(m, n));
    }
```

Or:

```
int pos;
for (pos = BOARD_MIN; pos < BOARD_MAX; pos++) {
    if (ON_BOARD(pos))
        do_something(pos);
}
```

15.3 Incremental Board data structures

In addition to the global board state, the algorithms in `'board.c'` implement a method of incremental updates that keeps track of the following information for each string:

- The color of the string.
- Number of stones in the string.
- Origin of the string, i.e. a canonical reference point, defined to be the stone with smallest 1D board coordinate.
- A list of the stones in the string.
- Number of liberties.
- A list of the liberties. If there are too many liberties the list is truncated.
- The number of neighbor strings.

- A list of the neighbor strings.

The basic data structure is

```

struct string_data {
    int color;                /* Color of string, BLACK or WHITE */
    int size;                /* Number of stones in string. */
    int origin;              /* Coordinates of "origin", i.e. */
                            /* "upper left" stone. */
    int liberties;           /* Number of liberties. */
    int libs[MAX_LIBERTIES]; /* Coordinates of liberties. */
    int neighbors;           /* Number of neighbor strings */
    int neighborlist[MAXCHAIN]; /* List of neighbor string numbers. */
    int mark;                /* General purpose mark. */
};

struct string_data string[MAX_STRINGS];

```

It should be clear that almost all information is stored in the `string` array. To get a mapping from the board coordinates to the `string` array we have

```
static int string_number[BOARDMAX];
```

which contains indices into the `string` array. This information is only valid at nonempty vertices, however, so it is necessary to first verify that `board[pos] != EMPTY`.

The `string_data` structure does not include an array of the stone coordinates. This information is stored in a separate array:

```
static int next_stone[BOARDMAX];
```

This array implements cyclic linked lists of stones. Each vertex contains a pointer to another (possibly the same) vertex. Starting at an arbitrary stone on the board, following these pointers should traverse the entire string in an arbitrary order before coming back to the starting point. As for the 'string_number' array, this information is invalid at empty points on the board. This data structure has the good properties of requiring fixed space (regardless of the number of strings) and making it easy to add a new stone or join two strings.

Additionally the code makes use of some work variables:

```

static int ml[BOARDMAX];
static int liberty_mark;
static int string_mark;
static int next_string;
static int strings_initialized = 0;

```

The `ml` array and `liberty_mark` are used to "mark" liberties on the board, e.g. to avoid counting the same liberty twice. The convention is that if `ml[pos]` has the same value as `liberty_mark`, then `pos` is marked. To clear all marks it suffices to increase the value of `liberty_mark`, since it is never allowed to decrease.

The same relation holds between the `mark` field of the `string_data` structure and `string_mark`. Of course these are used for marking individual strings.

`next_string` gives the number of the next available entry in the `string` array. Then `strings_initialized` is set to one when all data structures are known to be up to date.

Given an arbitrary board position in the ‘board’ array, this is done by calling `incremental_board_init()`. It is not necessary to call this function explicitly since any other function that needs the information does this if it has not been done.

The interesting part of the code is the incremental update of the data structures when a stone is played and subsequently removed. To understand the strategies involved in adding a stone it is necessary to first know how undoing a move works. The idea is that as soon as some piece of information is about to be changed, the old value is pushed onto a stack which stores the value and its address. The stack is built from the following structures:

```
struct change_stack_entry {
    int *address;
    int value;
};

struct change_stack_entry change_stack[STACK_SIZE];
int change_stack_index;
```

and manipulated with the macros

```
BEGIN_CHANGE_RECORD()
PUSH_VALUE(v)
POP_MOVE()
```

Calling `BEGIN_CHANGE_RECORD()` stores a null pointer in the address field to indicate the start of changes for a new move. As mentioned earlier `PUSH_VALUE()` stores a value and its corresponding address. Assuming that all changed information has been duly pushed onto the stack, undoing the move is only a matter of calling `POP_MOVE()`, which simply assigns the values to the addresses in the reverse order until the null pointer is reached. This description is slightly simplified because this stack can only store ‘int’ values and we need to also store changes to the board. Thus we have two parallel stacks where one stores `int` values and the other one stores `Intersection` values.

When a new stone is played on the board, first captured opponent strings, if any, are removed. In this step we have to push the board values and the `next_stone` pointers for the removed stones, and update the liberties and neighbor lists for the neighbors of the removed strings. We do not have to push all information in the ‘string’ entries of the removed strings however. As we do not reuse the entries they will remain intact until the move is pushed and they are back in use.

After this we put down the new stone and get three distinct cases:

1. The new stone is isolated, i.e. it has no friendly neighbor.
2. The new stone has exactly one friendly neighbor.
3. The new stone has at least two friendly neighbors.

The first case is easiest. Then we create a new string by using the number given by `next_string` and increasing this variable. The string will have size one, `next_stone` points directly back on itself, the liberties can be found by looking for empty points in the four directions, possible neighbor strings are found in the same way, and those need also to remove one liberty and add one neighbor.

In the second case we do not create a new string but extend the neighbor with the new stone. This involves linking the new stone into the cyclic chain, if needed moving the origin, and updating liberties and neighbors. Liberty and neighbor information also needs updating for the neighbors of the new stone.

In the third case finally, we need to join already existing strings. In order not to have to store excessive amounts of information, we create a new string for the new stone and let it assimilate the neighbor strings. Thus all information about those can simply be left around in the 'string' array, exactly as for removed strings. Here it becomes a little more complex to keep track of liberties and neighbors since those may have been shared by more than one of the joined strings. Making good use of marks it all becomes rather straightforward anyway.

The often used construction

```
pos = FIRST_STONE(s);
do {
    ...
    pos = NEXT_STONE(pos);
} while (!BACK_TO_FIRST_STONE(s, pos));
```

traverses the stones of the string with number 's' exactly once, with `pos` holding the coordinates. In general `pos` is used as board coordinate and 's' as an index into the `string` array or sometimes a pointer to an entry in the `string` array.

15.4 Some Board Functions

Reading, often called **search** in computer game theory, is a fundamental process in GNU Go. This is the process of generating hypothetical future boards in order to determine the answer to some question, for example "can these stones live." Since these are hypothetical future positions, it is important to be able to undo them, ultimately returning to the present board. Thus a move stack is maintained during reading. When a move is tried, by the function `trymove`, or its variant `tryko`. This function pushes the current board on the stack and plays a move. The stack pointer `stackp`, which keeps track of the position, is incremented. The function `popgo()` pops the move stack, decrementing `stackp` and undoing the last move made.

Every successful `trymove()` must be matched with a `popgo()`. Thus the correct way of using this function is:

```
if (trymove(pos, color, ... )) {
    ... [potentially lots of code here]
    popgo();
}
```

In case the move is a ko capture, the legality of the capture is subject to the komaster scheme (see [Section 11.4 \[Ko\], page 117](#)).

- `int trymove(int pos, int color, const char *message)`

Returns true if (`pos`) is a legal move for `color`. In that case, it pushes the board on the stack and makes the move, incrementing `stackp`. If the

reading code is recording reading variations (as with ‘--decide-string’ or with ‘-o’), the string `*message` will be inserted in the SGF file as a comment. The comment will also refer to the string at `str` if this is not 0. The value of `str` can be `NO_MOVE` if it is not needed but otherwise the location of `str` is included in the comment.

- `int tryko(int pos, int color, const char *message)`
`tryko()` pushes the position onto the stack, and makes a move `pos` of `color`. The move is allowed even if it is an illegal ko capture. It is to be imagined that `color` has made an intervening ko threat which was answered and now the continuation is to be explored. Return 1 if the move is legal with the above caveat. Returns zero if it is not legal because of suicide.
- `void popgo()`
Pops the move stack. This function must (eventually) be called after a successful `trymove` or `tryko` to restore the board position. It undoes all the changes done by the call to `trymove/tryko` and leaves the board in the same state as it was before the call.
NOTE: If `trymove/tryko` returns 0, i.e. the tried move was not legal, you must **not** call `popgo`.
- `int komaster_trymove(int pos, int color, const char *message, int str, int *is_conditional_ko, int consider_conditional_ko)`
Variation of `trymove/tryko` where ko captures (both conditional and unconditional) must follow a komaster scheme (see [Section 11.4 \[Ko\]](#), [page 117](#)).

As you see, `trymove()` plays a move which can be easily retracted (with `popgo()`) and it is called thousands of times per actual game move as GNU Go analyzes the board position. By contrast the function `play_move()` plays a move which is intended to be permanent, though it is still possible to undo it if, for example, the opponent retracts a move.

- `void play_move(int pos, int color)`
Play a move. If you want to test for legality you should first call `is_legal()`. This function strictly follows the algorithm:
 1. Place a stone of given color on the board.
 2. If there are any adjacent opponent strings without liberties, remove them and increase the prisoner count.
 3. If the newly placed stone is part of a string without liberties, remove it and increase the prisoner count.
In spite of the name “permanent move”, this move can (usually) be unplayed by `undo_move()`, but it is significantly more costly than unplaying a temporary move. There are limitations on the available move history, so under certain circumstances the move may not be possible to unplay at a later time.
- `int undo_move(int n)`
Undo ‘`n`’ permanent moves. Returns 1 if successful and 0 if it fails. If ‘`n`’ moves cannot be undone, no move is undone.

Other board functions are documented in See [Section 18.3 \[Board Utilities\]](#), page 174.

16 Handling SGF trees in memory

SGF - Smart Game Format - is a file format which is used for storing game records for a number of different games, among them chess and go. The format is a framework with special adaptations to each game. This is not a description of the file format standard. To see the exact definition of the file format, see <http://www.red-bean.com/sgf/>.

GNU Go contains a library to handle go game records in the SGF format in memory and to read and write SGF files. This library - `libsgf.a` - is in the `sgf` subdirectory. To use the SGF routines, include the file `'sgftree.h'`.

Each game record is stored as a tree of *nodes*, where each node represents a state of the game, often after some move is made. Each node contains zero or more *properties*, which gives meaning to the node. There can also be a number of *child nodes* which are different variations of the game tree. The first child node is the main variation.

Here is the definition of `SGFNode`, and `SGFProperty`, the data structures which are used to encode the game tree.

```
typedef struct SGFProperty_t {
    struct SGFProperty_t *next;
    short  name;
    char  value[1];
} SGFProperty;

typedef struct SGFNode_t {
    SGFProperty      *props;
    struct SGFNode_t *parent;
    struct SGFNode_t *child;
    struct SGFNode_t *next;
} SGFNode;
```

Each node of the SGF tree is stored in an `SGFNode` struct. It has a pointer to a linked list of properties (see below) called `props`. It also has a pointer to a linked list of children, where each child is a variation which starts at this node. The variations are linked through the `next` pointer and each variation continues through the `child` pointer. Each and every node also has a pointer to its parent node (the `parent` field), except the top node whose parent pointer is `NULL`.

An SGF property is encoded in the `SGFProperty` struct. It is linked in a list through the `next` field. A property has a `name` which is encoded in a short int. Symbolic names of properties can be found in `'sgf_properties.h'`.

Some properties also have a value, which could be an integer, a floating point value, a character or a string. These values can be accessed or set through special functions.

16.1 The SGFTree datatype

Sometimes we just want to record an ongoing game or something similarly simple and not do any sophisticated tree manipulation. In that case we can use the simplified interface provided by `SGFTree` below.

```
typedef struct SGFTree_t {
    SGFNode *root;
    SGFNode *lastnode;
} SGFTree;
```

An `SGFTree` contains a pointer to the root node of an SGF tree and a pointer to the node that we last accessed. Most of the time this will be the last move of an ongoing game.

Most of the functions which manipulate an `SGFTree` work exactly like their `SGFNode` counterparts, except that they work on the current node of the tree.

All the functions below that take arguments `tree` and `node` will work on:

1. `node` if non-NULL
2. `tree->lastnode` if non-NULL
3. The current end of the game tree.

in that order.

17 Application Programmers Interface to GNU Go

If you want to write your own interface to GNU Go, or if you want to create a go application using the GNU Go engine, this chapter is of interest to you.

First an overview: GNU Go consists of two parts: the GNU Go *engine* and a program (user interface) which uses this engine. These are linked together into one binary. The current program implements the following user modes:

- An interactive board playable on ASCII terminals
- solo play - GNU Go plays against itself
- replay - a mode which lets the user investigate moves in an existing SGF file.
- GMP - Go Modem Protocol, a protocol for automatic play between two computers.
- GTP - Go Text Protocol, a more general go protocol, see [Chapter 19 \[GTP\]](#), page 179.

The GNU Go engine can be used in other applications. For example, supplied with GNU Go is another program using the engine, called ‘debugboard’, in the directory ‘interface/debugboard/'. The program debugboard lets the user load SGF files and can then interactively look at different properties of the position such as group status and eye status.

The purpose of this Chapter is to show how to interface your own program such as debugboard with the GNU Go engine.

Figure 1 describes the structure of a program using the GNU Go engine.

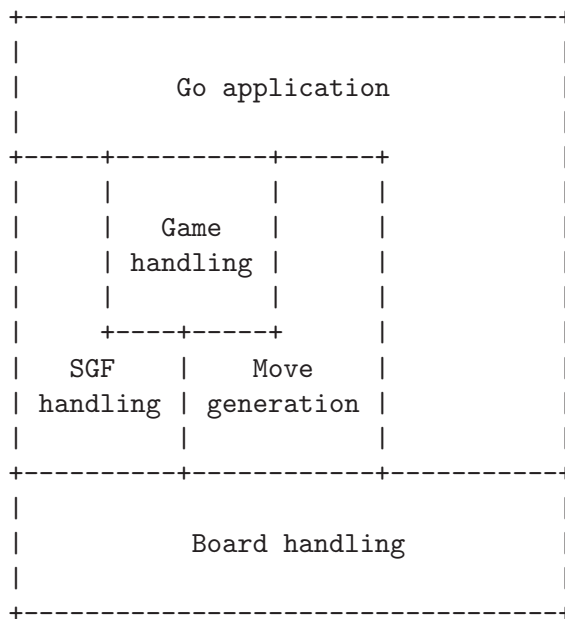

Figure 1: The structure of a program using the GNU Go engine

The foundation is a library called `libboard.a` which provides efficient handling of a go board with rule checks for moves, with incremental handling of connected strings of stones and with methods to efficiently hash go positions.

On top of this, there is a library which helps the application use Smart Game Format (SGF) files, with complete handling of game trees in memory and in files. This library is called `libsgf.a`

The main part of the code within GNU Go is the move generation library which given a position generates a move. This part of the engine can also be used to manipulate a go position, add or remove stones, do tactical and strategic reading and to query the engine for legal moves. These functions are collected into `libengine.a`.

The game handling code helps the application programmer keep tracks of the moves in a game. Games can be saved to SGF files and then later be read back again. These are also within `libengine.a`.

The responsibility of the application is to provide the user with a user interface, graphical or not, and let the user interact with the engine.

17.1 How to use the engine in your own program: getting started

To use the GNU Go engine in your own program you must include the file `gnugo.h`. This file describes the whole public API. There is another file, `liberty.h`, which describes the internal interface within the engine. If you want to make a new module within the engine, e.g. for suggesting moves you will have to include this file also. In this section we will only describe the public interface.

Before you do anything else, you have to call the function `init_gnugo()`. This function initializes everything within the engine. It takes one parameter: the number of megabytes the engine can use for the internal hash table. In addition to this the engine will use a few megabytes for other purposes such as data describing groups (liberties, life status, etc), eyes and so on.

17.2 Basic Data Structures in the Engine

There are some basic definitions in `gnugo.h` which are used everywhere. The most important of these are the numeric declarations of colors. Each intersection on the board is represented by one of these:

color	value
EMPTY	0
WHITE	1
BLACK	2

There is a macro, `OTHER_COLOR(color)` which can be used to get the other color than the parameter. This macro can only be used on `WHITE` or `BLACK`, but not on `EMPTY`.

GNU Go uses two different representations of the board, for most purposes a one-dimensional one, but for a few purposes a two dimensional one (see [Chapter 15 \[Libboard\]](#), [page 150](#)). The one-dimensional board was introduced before GNU Go 3.2, while the two-dimensional board dates back to the ancestral program written by Man Lung Li before 1995. The API still uses the two-dimensional board, so the API functions have not changed much since GNU Go 3.0.

17.3 The board_state struct

A basic data structure in the engine is the `board_state` struct. This structure is internal to the engine and is defined in `'liberty.h'`.

```
typedef unsigned char Intersection;

struct board_state {
    int board_size;

    Intersection board[BOARDSIZE];
    int board_ko_pos;
    int black_captured;
    int white_captured;

    Intersection initial_board[BOARDSIZE];
    int initial_board_ko_pos;
    int initial_white_captured;
    int initial_black_captured;
    int move_history_color[MAX_MOVE_HISTORY];
    int move_history_pos[MAX_MOVE_HISTORY];
    int move_history_pointer;

    float komi;
    int move_number;
};
```

Here `Intersection` stores `EMPTY`, `WHITE` or `BLACK`. It is currently defined as an `unsigned char` to make it reasonably efficient in both storage and access time. The board state contains an array of `Intersection`'s representing the board. The move history is contained in the struct. Also contained in the struct is the location of a ko (`EMPTY`) if the last move was not a ko capture, the komi, the number of captures, and corresponding data for the initial position at the beginning of the move history.

17.4 Functions which manipulate a Position

All the functions in the engine that manipulate Positions have names prefixed by `gnugo_`. These functions still use the two-dimensional representation of the board (see [Section 15.2 \[The Board Array\]](#), page 151). Here is a complete list, as prototyped in `'gnugo.h'`:

- `void init_gnugo(float memory)`
Initialize the gnugo engine. This needs to be called once only.
- `void gnugo_clear_board(int boardsize)`
Clear the board.
- `void gnugo_set_komi(float new_komi)`
Set the komi.

- `void gnugo_add_stone(int i, int j, int color)`
Place a stone on the board
- `void gnugo_remove_stone(int i, int j)`
Remove a stone from the board
- `int gnugo_is_pass(int i, int j)`
Return true if (i,j) is PASS_MOVE
- `void gnugo_play_move(int i, int j, int color)`
Play a move and start the clock
- `int gnugo_undo_move(int n)`
Undo n permanent moves. Returns 1 if successful and 0 if it fails. If n moves cannot be undone, no move is undone.
- `int gnugo_play_sgfnode(SGFNode *node, int to_move)`
Perform the moves and place the stones from the SGF node on the board. Return the color of the player whose turn it is to move.
- `int gnugo_play_sgftree(SGFNode *root, int *until, SGFNode **curnode)`
Play the moves in ROOT UNTIL movenumber is reached. Return the color of the player whose turn it is to move.
- `int gnugo_is_legal(int i, int j, int color)`
Interface to `is_legal()`.
- `int gnugo_is_suicide(int i, int j, int color)`
Interface to `is_suicide()`.
- `int gnugo_placehand(int handicap)`
Interface to `placehand`. Sets up handicap pieces and returns the number of placed handicap stones.
- `void gnugo_recordboard(SGFNode *root)`
Interface to `sgffile_recordboard()`
- `int gnugo_sethand(int handicap, SGFNode *node)`
Interface to `placehand`. Sets up handicap stones and returns the number of placed handicap stones, updating the sgf file
- `float gnugo_genmove(int *i, int *j, int color, int *resign)`
Interface to `genmove()`.
- `int gnugo_attack(int m, int n, int *i, int *j)`
Interface to `attack()`.
- `int gnugo_find_defense(int m, int n, int *i, int *j)`
Interface to `find_defense()`.
- `void gnugo_who_wins(int color, FILE *outfile)`
Interface to `who_wins()`.
- `float gnugo_estimate_score(float *upper, float *lower)`
Put upper and lower score estimates into `*upper`, `*lower` and return the average. A positive score favors white. In computing the upper bound,

CRITICAL dragons are awarded to white; in computing the lower bound, they are awarded to black.

- `void gnugo_examine_position(int color, int how_much)`
Interface to `examine_position`.
- `int gnugo_get_komi()`
Report the komi.
- `void gnugo_get_board(int b[MAX_BOARD] [MAX_BOARD])`
Place the board into the ‘b’ array.
- `int gnugo_get_boardsize()`
Report the board size.
- `int gnugo_get_move_number()`
Report the move number.

17.5 Game handling

The functions (in see [Section 17.4 \[Positional Functions\], page 163](#)) are all that are needed to create a fully functional go program. But to make the life easier for the programmer, there is a small set of functions specially designed for handling ongoing games.

The data structure describing an ongoing game is the `Gameinfo`. It is defined as follows:

```
typedef struct {
    int      handicap;

    int      to_move;          /* whose move it currently is */
    SGFtree  game_record;     /* Game record in sgf format. */

    int      computer_player; /* BLACK, WHITE, or EMPTY (used as BOTH) */

    char      outfilename[128]; /* Trickle file */
    FILE      *outfile;

} Gameinfo;
```

The meaning of `handicap` should be obvious. `to_move` is the color of the side whose turn it is to move.

The SGF tree `game_record` is used to store all the moves in the entire game, including a header node which contains, among other things, komi and handicap.

If one or both of the opponents is the computer, the field `computer_player` is used. Otherwise it can be ignored.

GNU Go can use a trickle file to continuously save all the moves of an ongoing game. This file can also contain information about internal state of the engine such as move reasons for various locations or move valuations. The name of this file should be stored in `outfilename` and the file pointer to the open file is stored in `outfile`. If no trickle file is used, `outfilename[0]` will contain a null character and `outfile` will be set to `NULL`.

17.5.1 Functions which manipulate a Gameinfo

All the functions in the engine that manipulate Gameinfos have names prefixed by `gameinfo_`. Here is a complete list, as prototyped in `gnugo.h`:

- `void gameinfo_clear(Gameinfo *ginfo, int boardsize, float komi)`
Initialize the `Gameinfo` structure.
- `void gameinfo_print(Gameinfo *ginfo)`
Print a `gameinfo`.
- `void gameinfo_load_sgfheader(Gameinfo *gameinfo, SGFNode *head)`
Reads header info from `sgf` structure and sets the appropriate variables.
- `void gameinfo_play_move(Gameinfo *ginfo, int i, int j, int color)`
Make a move in the game. Return 1 if the move was legal. In that case the move is actually done. Otherwise return 0.
- `int gameinfo_play_sgftree_rot(Gameinfo *gameinfo, SGFNode *head, const char *untilstr, int orientation)`
Play the moves in an `SGF` tree. Walk the main variation, actioning the properties into the playing board. Returns the color of the next move to be made. `Head` is an `sgf` tree. `Untilstr` is an optional string of the form either `'L12'` or `'120'` which tells it to stop playing at that move or move number. When debugging, this is the location of the move being examined.
- `int gameinfo_play_sgftree(Gameinfo *gameinfo, SGFNode *head, const char *untilstr)`
Same as previous function, using standard orientation.

18 Utility Functions

In this Chapter, we document some of the utilities which may be called from the GNU Go engine.

18.1 General Utilities

Utility functions from 'engine/utils.c'. Many of these functions underlie autohelper functions (see [Section 9.7 \[Autohelper Functions\]](#), page 84).

- `void change_dragon_status(int dr, int status)`
Change the status of all the stones in the dragon at `dr`.
- `int defend_against(int move, int color, int apos)`
Check whether a move at `move` stops the enemy from playing at (`apos`).
- `int cut_possible(int pos, int color)`
Returns true if `color` can cut at `pos`, or if connection through `pos` is inhibited. This information is collected by `find_cuts()`, using the B patterns in the connections database.
- `int does_attack(int move, int str)`
returns true if the move at `move` attacks `str`. This means that it captures the string, and that `str` is not already dead.
- `int does_defend(int move, int str)`
`does_defend(move, str)` returns true if the move at `move` defends `str`. This means that it defends the string, and that `str` can be captured if no defense is made.
- `int somewhere(int color, int last_move, ...)`
Example: `somewhere(WHITE, 2, apos, bpos, cpos)`. Returns true if one of the vertices listed satisfies `board[pos]==color`. Here `num_moves` is the number of moves minus one. If the check is true the dragon is not allowed to be dead. This check is only valid if `stackp==0`.
- `int visible_along_edge(int color, int apos, int bpos)`
Search along the edge for the first visible stone. Start at `apos` and move in the direction of `bpos`. Return 1 if the first visible stone is of the given color. It is required that `apos` and `bpos` are at the same distance from the edge.
- `int test_symmetry_after_move(int move, int color, int strict)`
Is the board symmetric (or rather antisymmetric) with respect to mirroring in `tengen` after a specific move has been played? If the move is `PASS_MOVE`, check the current board. If `strict` is set we require that each stone is matched by a stone of the opposite color at the mirrored vertex. Otherwise we only require that each stone is matched by a stone of either color.
- `int play_break_through_n(int color, int num_moves, ...)`
The function `play_break_through_n()` plays a sequence of moves, alternating between the players and starting with `color`. After having played

through the sequence, the three last coordinate pairs gives a position to be analyzed by `break_through()`, to see whether either color has managed to enclose some stones and/or connected his own stones. If any of the three last positions is empty, it's assumed that the enclosure has failed, as well as the attempt to connect. If one or more of the moves to play turns out to be illegal for some reason, the rest of the sequence is played anyway, and `break_through()` is called as if nothing special happened. Like `break_through()`, this function returns 1 if the attempt to break through was succesful and 2 if it only managed to cut through.

- `int play_attack_defend_n(int color, int do_attack, int num_moves, ...)`
- `int play_attack_defend2_n(int color, int do_attack, int num_moves, ...)`

The function `play_attack_defend_n()` plays a sequence of moves, alternating between the players and starting with `color`. After having played through the sequence, the last coordinate pair gives a target to attack or defend, depending on the value of `do_attack`. If there is no stone present to attack or defend, it is assumed that it has already been captured. If one or more of the moves to play turns out to be illegal for some reason, the rest of the sequence is played anyway, and attack/defense is tested as if nothing special happened. Conversely, `play_attack_defend2_n()` plays a sequence of moves, alternating between the players and starting with `color`. After having played through the sequence, the two last coordinate pairs give two targets to simultaneously attack or defend, depending on the value of `do_attack`. If there is no stone present to attack or defend, it is assumed that it has already been captured. If one or more of the moves to play turns out to be illegal for some reason, the rest of the sequence is played anyway, and attack/defense is tested as if nothing special happened. A typical use of these functions is to set up a ladder in an autohelper and see whether it works or not.

- `int play_connect_n(int color, int do_connect, int num_moves, ...)`
Plays a sequence of moves, alternating between the players and starting with `color`. After having played through the sequence, the two last coordinates give two targets that should be connected or disconnected, depending on the value of `do_connect`. If there is no stone present to connect or disconnect, it is assumed that the connection has failed. If one or more of the moves to play turns out to be illegal for some reason, the rest of the sequence is played anyway, and connection/disconnection is tested as if nothing special happened. Ultimately the connection is decided by the functions `string_connect` and `disconnect` (see [Section 11.10 \[Connection Reading\]](#), page 125).
- `void set_depth_values(int level)`

It is assumed in reading a ladder if `stackp >= depth` that as soon as a bounding stone is in atari, the string is safe. Similar uses are made of the other depth parameters such as `backfill_depth` and so forth. In short, simplifying assumptions are made when `stackp` is large. Unfortunately any such scheme invites the “horizon effect,” in which a stalling move is

perceived as a win, by pushing the refutation past the “horizon”—the value of `stackp` in which the reading assumptions are relaxed. To avoid the depth it is sometimes necessary to increase the depth parameters. This function can be used to set the various reading depth parameters. If `mandated_depth_value` is not -1 that value is used; otherwise the depth values are set as a function of level. The parameter `mandated_depth_value` can be set at the command line to force a particular value of depth; normally it is -1.

- `void modify_depth_values(int n)`
 Modify the various tactical reading depth parameters. This is typically used to avoid horizon effects. By temporarily increasing the depth values when trying some move, one can avoid that an irrelevant move seems effective just because the reading hits a depth limit earlier than it did when reading only on relevant moves.
- `void increase_depth_values(void)`
`modify_depth_values(1).`
- `void decrease_depth_values(void)`
`modify_depth_values(-1).`
- `void restore_depth_values()`
 Sets `depth` and so forth to their saved values.
- `void set_temporary_depth_values(int d, int b, int b2, int bc, int ss, int br, int f, int k)`
 Explicitly set the depth values. This function is currently never called.
- `int confirm_safety(int move, int color, int *defense_point, char safe_stones[BOARDMAX])`
 Check that the move at `color` doesn't involve any kind of blunder, regardless of size.
- `float blunder_size(int move, int color, int *defense_point, char safe_stones[BOARDMAX])`
 This function will detect some blunders. If the move reduces the number of liberties of an adjacent friendly string, there is a danger that the move could backfire, so the function checks that no friendly worm which was formerly not attackable becomes attackable, and it checks that no opposing worm which was not defendable becomes defendable. It returns the estimated size of the blunder, or 0.0 if nothing bad has happened. The array `safe_stones[]` contains the stones that are supposedly safe after `move`. It may be NULL. For use when called from `fill_liberty()`, this function may optionally return a point of defense, which, if taken, will presumably make the move at `move` safe on a subsequent turn.
- `int double_atari(int move, int color, float *value, char safe_stones[BOARDMAX])`
 Returns true if a move by (`color`) fits the following shape:

```

X*           (0=color)

```

OX

capturing one of the two 'X' strings. The name is a slight misnomer since this includes attacks which are not necessarily double ataris, though the common double atari is the most important special case. If `safe_stones != NULL`, then only attacks on stones marked as safe are tried. The value of the double atari attack is returned in value (unless value is NULL), and the attacked stones are marked unsafe.

- `void unconditional_life(int unconditional_territory[BOARDMAX], int color)`

Find those worms of the given color that can never be captured, even if the opponent is allowed an arbitrary number of consecutive moves. The coordinates of the origins of these worms are written to the worm arrays and the number of non-capturable worms is returned. The algorithm is to cycle through the worms until none remains or no more can be captured. A worm is removed when it is found to be capturable, by letting the opponent try to play on all its liberties. If the attack fails, the moves are undone. When no more worm can be removed in this way, the remaining ones are unconditionally alive. After this, unconditionally dead opponent worms and unconditional territory are identified. To find these, we continue from the position obtained at the end of the previous operation (only unconditionally alive strings remain for color) with the following steps:

1. Play opponent stones on all liberties of the unconditionally alive strings except where illegal. (That the move order may determine exactly which liberties can be played legally is not important. Just pick an arbitrary order).
2. Recursively extend opponent strings in atari, except where this would be suicide.
3. Play an opponent stone anywhere it can get two empty neighbors. (I.e. split big eyes into small ones).
4. an opponent stone anywhere it can get one empty neighbor. (I.e. reduce two space eyes to one space eyes.) Remaining opponent strings in atari and remaining liberties of the unconditionally alive strings constitute the unconditional territory. Opponent strings from the initial position placed on unconditional territory are unconditionally dead. On return, `unconditional_territory[][]` is 1 where color has unconditionally alive stones, 2 where it has unconditional territory, and 0 otherwise.

- `void who_wins(int color, FILE *outfile)`

Score the game and determine the winner

- `void find_superstring(int str, int *num_stones, int *stones)`

Find the stones of an extended string, where the extensions are through the following kinds of connections:

1. Solid connections (just like ordinary string).

2. Diagonal connection or one space jump through an intersection where an opponent move would be suicide or self-atari.

```

...
0.0
XOX
X.X

```

3. Bamboo joint.

```

00
..
00

```

4. Diagonal connection where both adjacent intersections are empty.

```

.0
0.

```

5. Connection through adjacent or diagonal tactically captured stones. Connections of this type are omitted when the superstring code is called from `reading.c`, but included when the superstring code is called from `owl.c`

- `void find_superstring_liberties(int str, int *num_libs, int *libs, int liberty_cap)`

This function computes the superstring at `str` as described above, but omitting connections of type 5. Then it constructs a list of liberties of the superstring which are not already liberties of `str`. If `liberty_cap` is nonzero, only liberties of substrings of the superstring which have fewer than `liberty_cap` liberties are generated.

- `void find_proper_superstring_liberties(int str, int *num_libs, int *libs, int liberty_cap)`

This function is the same as `find_superstring_liberties`, but it omits those liberties of the string `str`, presumably since those have already been treated elsewhere. If `liberty_cap` is nonzero, only liberties of substrings of the superstring which have at most `liberty_cap` liberties are generated.

- `void find_superstring_stones_and_liberties(int str, int *num_stones, int *stones, int *num_libs, int *libs, int liberty_cap)`

This function computes the superstring at `str` as described above, but omitting connections of type 5. Then it constructs a list of liberties of the superstring which are not already liberties of `str`. If `liberty_cap` is nonzero, only liberties of substrings of the superstring which have fewer than `liberty_cap` liberties are generated.

- `void superstring_chainlinks(int str, int *num_adj, int adjs[MAXCHAIN], int liberty_cap)`

analogous to `chainlinks`, this function finds boundary chains of the superstring at `str`, including those which are boundary chains of `str` itself. If `liberty_cap != 0`, only those boundary chains with `<= liberty_cap` liberties are reported.

- `void proper_superstring_chainlinks(int str, int *num_adj, int adjs[MAXCHAIN], int liberty_cap)`
analogous to `chainlinks`, this function finds boundary chains of the superstring at `str`, omitting those which are boundary chains of `str` itself. If `liberty_cap != 0`, only those boundary chains with `<= liberty_cap` liberties are reported.
- `void start_timer(int n)`
Start a timer. GNU Go has four internal timers available for assessing the time spent on various tasks.
- `double time_report(int n, const char *occupation, int move, double mintime)`
Report time spent and restart the timer. Make no report if elapsed time is less than `mintime`.

18.2 Print Utilities

Functions in ‘`engine/printutils.c`’ do formatted printing similar to `printf` and its allies. The following formats are recognized:

- `%c, %d, %f, %s, %x`
These have their usual meaning in formatted output, printing a character, integer, float, string or hexadecimal, respectively.
- `%o`
‘Outdent.’ Normally output is indented by `2*stackp` spaces, so that the depth can be seen at a glance in traces. At the beginning of a format, this `%o` inhibits the indentation.
- `%H`
Print a hashvalue.
- `%C`
Print a color as a string.
- `%m, %2m` (synonyms)
Takes 2 integers and writes a move, using the two dimensional board representation (see [Section 15.2 \[The Board Array\], page 151](#))
- `%1m`
Takes 1 integers and writes a move, using the one dimensional board representation (see [Section 15.2 \[The Board Array\], page 151](#))

We list the non statically declared functions in ‘`printutils.c`’.

- `void gfprintf(FILE *outfile, const char *fmt, ...)`
Formatted output to ‘`outfile`’.
- `int gprintf(const char *fmt, ...)`
Formatted output to `stderr`. Always returns 1 to allow use in short-circuit logical expressions.

- `int mprintf(const char *fmt, ...)`
Formatted output to stdout.
- `DEBUG(level, fmt, args...)`
If `level & debug`, do formatted output to `stderr`. Otherwise, ignore.
- `void abortgo(const char *file, int line, const char *msg, int pos)`
Print debugging output in an error situation, then exit.
- `const char * color_to_string(int color)`
Convert a color value to a string
- `const char * location_to_string(int pos)`
Convert a location to a string
- `void location_to_buffer(int pos, char *buf)`
Convert a location to a string, writing to a buffer.
- `int string_to_location(int boardsize, char *str, int *m, int *n)`
Get the (m, n) coordinates in the standard GNU Go coordinate system from the string `str`. This means that 'm' is the nth row from the top and 'n' is the column. Both coordinates are between 0 and `boardsize-1`, inclusive. Return 1 if ok, otherwise return 0;
- `int is_hoshi_point(int m, int n)` True if the coordinate is a hoshi point.
- `void draw_letter_coordinates(FILE *outfile)` Print a line with coordinate letters above the board.
- `void simple_showboard(FILE *outfile)`
Bare bones version of `showboard(0)`. No fancy options, no hint of color, and you can choose where to write it.

The following functions are in 'showbord.c'. Not all public functions in that file are listed here.

- `void showboard(int xo)`
Show go board.

<code>xo=0:</code>	black and white XO board for ascii game
<code>xo=1:</code>	colored dragon display
<code>xo=2:</code>	colored eye display
<code>xo=3:</code>	colored owl display
<code>xo=4:</code>	colored matcher status display
- `const char * status_to_string(int status)`
Convert a status value to a string.
- `const char * safety_to_string(int status)`
Convert a safety value to a string.
- `const char * result_to_string(int result)`
Convert a read result to a string

18.3 Board Utilities

The functions documented in this section are from ‘board.c’. Other functions in ‘board.c’ are described in See [Section 15.4 \[Some Board Functions\]](#), page 156.

- `void store_board(struct board_state *state)`
Save board state.
- `void restore_board(struct board_state *state)`
Restore a saved board state.
- `void clear_board(void)`
Clear the internal board.
- `void dump_stack(void)`
for use under GDB prints the move stack.
- `void add_stone(int pos, int color)`
Place a stone on the board and update the board_hash. This operation destroys all move history.
- `void remove_stone(int pos)`
Remove a stone from the board and update the board_hash. This operation destroys the move history.
- `int is_pass(int pos)`
Test if the move is a pass or not. Return 1 if it is.
- `int is_legal(int pos, int color)`
Determines whether the move color at pos is legal.
- `int is_suicide(int pos, int color)`
Determines whether the move color at pos would be a suicide. This is the case if
 1. There is no neighboring empty intersection.
 2. There is no neighboring opponent string with exactly one liberty.
 3. There is no neighboring friendly string with more than one liberty.
- `int is_illegal_ko_capture(int pos, int color)`
Determines whether the move color at pos would be an illegal ko capture.
- `int is_edge_vertex(int pos)`
Determine whether vertex is on the edge.
- `int edge_distance(int pos)`
Distance to the edge.
- `int is_corner_vertex(int pos)`
Determine whether vertex is a corner.
- `int get_komaster()`
- `int get_kom_pos()`
Public functions to access the variable komaster and kom_pos, which are static in ‘board.c’.

Next we come to `countlib()` and its allies, which address the problem of determining how many liberties a string has. Although `countlib()` addresses this basic question, other functions can often get the needed information more quickly, so there are a number of different functions in this family.

- `int countlib(int str)`

Count the number of liberties of the string at `pos`. There must be a stone at this location.

- `int findlib(int str, int maxlib, int *libs)`

Find the liberties of the string at `str`. This location must not be empty. The locations of up to `maxlib` liberties are written into `libs[]`. The full number of liberties is returned. If you want the locations of all liberties, whatever their number, you should pass `MAXLIBS` as the value for `maxlib` and allocate space for `libs[]` accordingly.

- `int fastlib(int pos, int color, int ignore_captures)`

Count the liberties a stone of the given color would get if played at `pos`. The intent of this function is to be as fast as possible, not necessarily complete. But if it returns a positive value (meaning it has succeeded), the value is guaranteed to be correct. Captures are ignored based if the `ignore_captures` field is nonzero. The location `pos` must be empty. The function fails if there are more than two neighbor strings of the same color. In this case, the return value is -1. Captures are handled in a very limited way, so if `ignore_capture` is 0, and a capture is required, it will often return -1.

- `int approxlib(int pos, int color, int maxlib, int *libs)`

Find the liberties a stone of the given color would get if played at `pos`, ignoring possible captures of opponent stones. The location `pos` must be empty. If `libs != NULL`, the locations of up to `maxlib` liberties are written into `libs[]`. The counting of liberties may or may not be halted when `maxlib` is reached. The number of liberties found is returned, which may be less than the total number of liberties if `maxlib` is small. If you want the number or the locations of all liberties, however many they are, you should pass `MAXLIBS` as the value for `maxlib` and allocate space for `libs[]` accordingly.

- `int accuratelib(int pos, int color, int maxlib, int *libs)`

Find the liberties a stone of the given color would get if played at `pos`. This function takes into consideration all captures. Its return value is exact in that sense it counts all the liberties, unless `maxlib` allows it to stop earlier. The location `pos` must be empty. If `libs != NULL`, the locations of up to `maxlib` liberties are written into `libs[]`. The counting of liberties may or may not be halted when `maxlib` is reached. The number of found liberties is returned. This function guarantees that liberties which are not results of captures come first in `libs[]` array. To find whether all the liberties starting from a given one are results of captures, one may use `if (board[libs[k]] != EMPTY)` construction. If you want the number or the

locations of all liberties, however many they are, you should pass `MAXLIBS` as the value for `maxlib` and allocate space for `libs[]` accordingly.

Next we have some general utility functions.

- `int count_common_libs(int str1, int str2)`
Find the number of common liberties of the two strings.
- `int find_common_libs(int str1, int str2, int maxlib, int *libs)`
Find the common liberties of the two strings. The locations of up to `maxlib` common liberties are written into `libs[]`. The full number of common liberties is returned. If you want the locations of all common liberties, whatever their number, you should pass `MAXLIBS` as the value for `maxlib` and allocate space for `libs[]` accordingly.
- `int have_common_lib(int str1, int str2, int *lib)`
Determine whether two strings have at least one common liberty. If they do and `lib != NULL`, one common liberty is returned in `*lib`.
- `int countstones(int str)`
Report the number of stones in a string.
- `int findstones(int str, int maxstones, int *stones)`
Find the stones of the string at `str`. The location must not be empty. The locations of up to `maxstones` stones are written into `stones[]`. The full number of stones is returned.
- `int chainlinks(int str, int adj[MAXCHAIN])`
This very useful function returns (in the `adj` array) the chains surrounding the string at `str`. The number of chains is returned.
- `int chainlinks2(int str, int adj[MAXCHAIN], int lib)`
Returns (in `adj` array) those chains surrounding the string at `str`, which has exactly `lib` liberties. The number of such chains is returned.
- `int chainlinks3(int str, int adj[MAXCHAIN], int lib)`
Returns (in `adj` array) the chains surrounding the string at `str`, which have less or equal `lib` liberties. The number of such chains is returned.
- `int extended_chainlinks(int str, int adj[MAXCHAIN], int both_colors)`
Returns (in the `adj` array) the opponent strings being directly adjacent to `str` or having a common liberty with `str`. The number of such strings is returned. If the `both_colors` parameter is true, also own strings sharing a liberty are returned.
- `int find_origin(int str)`
Find the origin of a string, i.e. the point with the smallest 1D board coordinate. The idea is to have a canonical reference point for a string.
- `int is_self_atari(int pos, int color)`
Determine whether a move by color at `pos` would be a self atari, i.e. whether it would get more than one liberty. This function returns true also for the case of a suicide move.

- `int liberty_of_string(int pos, int str)`
Returns true if `pos` is a liberty of the string at `str`.
- `int second_order_liberty_of_string(int pos, int str)`
Returns true if `pos` is a second order liberty of the string at `str`.
- `int neighbor_of_string(int pos, int str)`
Returns true if `pos` is adjacent to the string at `str`.
- `int has_neighbor(int pos, int color)`
Returns true if `pos` has a neighbor of `color`.
- `int same_string(int str1, int str2)`
Returns true if `str1` and `str2` belong to the same string.
- `int adjacent_strings(int str1, int str2)`
Returns true if the strings at `str1` and `str2` are adjacent.
- `int is_ko(int pos, int color, int *ko_pos)`
Return true if the move `pos` by `color` is a ko capture (whether capture is legal on this move or not). If so, and if `ko_pos` is not a NULL pointer, then `*ko_pos` returns the location of the captured ko stone. If the move is not a ko capture, `*ko_pos` is set to 0. A move is a ko capture if and only if
 1. All neighbors are opponent stones.
 2. The number of captured stones is exactly one.
- `int is_ko_point(int pos)`
Return true if `pos` is either a stone, which if captured would give ko, or if `pos` is an empty intersection adjacent to a ko stone.
- `int does_capture_something(int pos, int color)`
Returns 1 if at least one string is captured when `color` plays at `pos`.
- `void mark_string(int str, char mx[BOARDMAX], char mark)`
For each stone in the string at `pos`, set `mx` to value `mark`. If some of the stones in the string are marked prior to calling this function, only the connected unmarked stones starting from `pos` are guaranteed to become marked. The rest of the string may or may not become marked. (In the current implementation, it will.)
- `int move_in_stack(int pos, int cutoff)`
Returns true if at least one move has been played at `pos` at deeper than level `cutoff` in the reading tree.
- `int stones_on_board(int color)`
Return the number of stones of the indicated color(s) on the board. This only counts stones in the permanent position, not stones placed by `trymove()` or `tryko()`. Use `stones_on_board(BLACK | WHITE)` to get the total number of stones on the board.

18.4 Utilities from ‘engine/influence.c’

We will only list here a portion of the public functions in `influence.c`. The influence code is invoked through the function `compute_influence` (see [Section 13.3 \[Influence Usage\]](#), [page 130](#)). It is invoked as follows.

- `void compute_influence(int color, const char safe_stones[BOARDMAX], const float strength[BOARDMAX], struct influence_data *q, int move, const char *trace_message)`

Compute the influence values for both colors. The caller must

- set up the `board[]` state
- mark safe stones with `INFLUENCE_SAFE_STONE`, dead stones with 0
- mark stones newly saved by a move with `INFLUENCE_SAVED_STONE` (this is relevant if the `influence_data *q` is reused to compute a followup value for this move).

Results will be stored in `q`. `move` has no effects except toggling debugging. Set it to -1 for no debug output at all (otherwise it will be controlled by the ‘-m’ command line option). It is assumed that `color` is in turn to move. (This affects the barrier patterns (class A, D) and intrusions (class B)).
Color

Other functions in ‘`influence.c`’ are of the nature of utilities which may be useful throughout the engine. We list the most useful ones here.

- `void influence_mark_non_territory(int pos, int color)`
Called from actions for ‘t’ patterns in ‘`barriers.db`’. Marks `pos` as not being territory for `color`.
- `int whose_territory(const struct influence_data *q, int pos)`
Return the color of the territory at `pos`. If it’s territory for neither color, `EMPTY` is returned.
- `int whose_moyo(const struct influence_data *q, int pos)`
Return the color who has a moyo at `pos`. If neither color has a moyo there, `EMPTY` is returned. The definition of moyo in terms of the influences is totally ad hoc.
- `int whose_area(const struct influence_data *q, int pos)`
Return the color who has dominating influence (“area”) at `pos`. If neither color dominates the influence there, `EMPTY` is returned. The definition of area in terms of the influences is totally ad hoc.

19 The Go Text Protocol

19.1 The Go Text Protocol

GNU Go 3.0 introduced a new interface, the Go Text Protocol, abbreviated GTP. The intention was to make an interface that is better suited for machine-machine communication than the ascii interface and simpler, more powerful, and more flexible than the Go Modem Protocol.

There are two versions of the protocol. Version 1 was used with GNU Go 3.0 and 3.2. GNU Go 3.4 and later versions use protocol version 2. The specification of GTP version 2 is available at <http://www.lysator.liu.se/~gunnar/gtp/>. GNU Go 3.4 is the reference implementation for GTP version 2, but all but the most common commands are to be regarded as private extensions of the protocol.

The GTP has a variety of applications. For GNU Go the first use was in regression testing (see [Chapter 20 \[Regression\]](#), page 202), followed by communication with the NNGS go server and for automated test games against itself and other programs. Now there are also many graphical user interfaces available supporting GTP, as well as bridges to other Go servers than NNGS.

19.2 Running GNU Go in GTP mode

To start GNU Go in GTP mode, simply invoke it with the option ‘`--mode gtp`’. You will not get a prompt or any other output to start with but GNU Go is silently waiting for GTP commands.

A sample GTP session may look as follows:

```
virihare 462% ./gnugo --mode gtp
1 boardsize 7
=1

2 clear_board
=2

3 play black D5
=3

4 genmove white
=4 C3

5 play black C3
?5 illegal move

6 play black E3
=6

7 showboard
=7
```

```

      A B C D E F G
7 . . . . . 7
6 . . . . . 6
5 . . + X + . . 5
4 . . . + . . . 4
3 . . 0 . X . . 3
2 . . . . . 2      WHITE (O) has captured 0 stones
1 . . . . . 1      BLACK (X) has captured 0 stones
      A B C D E F G

8 quit
=8

```

Commands are given on a single line, starting by an optional identity number, followed by the command name and its arguments.

If the command is successful, the response starts by an equals sign ('='), followed by the identity number of the command (if any) and then the result. In this example all results were empty strings except for command 4 where the answer was the white move at C3, and command 7 where the result was a diagram of the current board position. The response ends by two consecutive newlines.

Failing commands are signified by a question mark ('?') instead of an equals sign, as in the response to command 5.

The detailed specification of the protocol can be found at <http://www.lysator.liu.se/~gunnar/gtp/>. The available commands in GNU Go may always be listed using the command `list_commands`. They are also documented in See [Section 19.6 \[GTP command reference\]](#), [page 184](#).

19.3 GTP applications

GTP is an asymmetric protocol involving two parties which we call controller and engine. The controller sends all commands and the engine only responds to these commands. GNU Go implements the engine end of the protocol.

With the source code of GNU Go is also distributed a number of applications implementing the controller end. Among the most interesting of these are:

- 'regression/regress.awk'

Script to run regressions. The script sends GTP commands to set up and evaluate positions to the engine and then analyzes the responses from the engine. More information about GTP based regression testing can be found in the regression chapter (see [Chapter 20 \[Regression\]](#), [page 202](#)).

- 'regression/regress.pl'

Perl script to run regressions, giving output which together with the CGI script 'regression/regress.plx' generates HTML views of the regressions.

- ‘`regression/regress.pike`’
Pike script to run regressions. More feature-rich and powerful than ‘`regress.awk`’.
- ‘`regression/view.pike`’
Pike script to examine a single regression testcase through a graphical board. This gives an easy way to inspect many of the GNU Go internals.
- ‘`interface/gtp_examples/twogtp`’
Perl script to play two engines against each other. The script essentially sets up both engines with desired boardsize, handicap, and komi, then relays moves back and forth between the engines.
- ‘`interface/gtp_examples/twogtp-a`’
An alternative Perl implementation of twogtp.
- ‘`interface/gtp_examples/twogtp.py`’
Implementation of twogtp in Python. Has more features than the Perl variants.
- ‘`interface/gtp_examples/twogtp.pike`’
Implementation of twogtp in Pike. Has even more features than the Python variant.
- ‘`interface/gtp_examples/2ptkgo.pl`’
Variation of twogtp which includes a graphical board.

More GTP applications, including bridges to go servers and graphical user interfaces, are listed at <http://www.lysator.liu.se/~gunnar/gtp/>.

19.4 The Metamachine

An interesting application of the GTP is the concept of using GNU Go as an “Oracle” that can be consulted by another process. This could be another computer program that asks GNU Go to generate future board positions, then evaluate them.

David Doshay at the University of California at Santa Cruz has done interesting experiments with a parallel engine, known as SlugGo, that is based on GNU Go. These are described in <http://lists.gnu.org/archive/html/gnugo-devel/2004-08/msg00060.html>.

The “Metamachine” experiment is a more modest approach using the GTP to communicate with a GNU Go process that is used as an oracle. The following scheme is used.

- The GNU Go “oracle” is asked to generate its top moves using the GTP `top_moves` commands.
- Both moves are tried and `estimate_score` is called from the resulting board position.
- The higher scoring position is selected as the engine’s move.

This scheme does not produce a stronger engine, but it is suggestive, and the SlugGo experiment seems to show that a more elaborate scheme along the same lines could produce a stronger engine.

Two implementations are distributed with GNU Go. Both make use of `fork` and `pipe` system calls, so they require a Unix-like environment. The Metamachine has been tested under GNU/Linux.

Important: If the Metamachine terminates normally, the GNU Go process will be killed. However there is a danger that something will go wrong. When you are finished running the Metamachine, it is a good idea to run `ps -A|grep gnugo` or `ps -aux|grep gnugo` to make sure there are no unterminated processes. (If there are, just kill them.)

19.4.1 The Standalone Metamachine

In `interface/gtp_examples/metamachine.c` is a standalone implementation of the Metamachine. Compile it with `cc -o metamachine metamachine.c` and run it. It forks a `gnugo` process with which it communicates through the GTP, to use as an oracle.

The following scheme is followed:

```

          stdin                pipe a
GTP client ----> Metamachine -----> GNU Go
          <----                <-----
          stdout               pipe b

```

Most commands issued by the client are passed along verbatim to GNU Go by the Metamachine. The exception is `gg_genmove`, which is intercepted then processed differently, as described above. The client is unaware of this, and only knows that it issued a `gg_genmove` command and received a reply. Thus to the the Metamachine appears as an ordinary GTP engine.

Usage: no arguments gives normal GTP behavior. `metamachine --debug` sends diagnostics to `stderr`.

19.4.2 GNU Go as a Metamachine

Alternatively, you may compile GNU Go with the configure option `'--enable-metamachine'`. This causes the file `oracle.c` to be compiled, which contains the Metamachine code. This has no effect on the engine unless you run GNU Go with the runtime option `'--metamachine'`. Thus you must use both the configure and the runtime option to get the Metamachine.

This method is better than the standalone program since you have access to GNU Go's facilities. For example, you can run the Metamachine with CGoban or in Ascii mode this way.

You can get traces by adding the command line `'-d0x1000000'`. In debugging the Metamachine, a danger is that any small oversight in designing the program can cause the forked process and the controller to hang, each one waiting for a response from the other. If this seems to happen it is useful to know that you can attach `gdb` to a running process and find out what it is doing.

19.5 Adding new GTP commands

The implementation of GTP in GNU Go is distributed over three files, `interface/gtp.h`, `interface/gtp.c`, and `interface/play_gtp.c`. The first two implement a small library of helper functions which can be used also by other programs. In the interest of promoting the GTP they are licensed with minimal restrictions (see [Section A.6 \[GTP License\]](#), [page 225](#)). The actual GTP commands are implemented in `play_gtp.c`, which has knowledge about the engine internals.

To see how a simple but fairly typical command is implemented we look at `gtp_countlib()` (a GNU Go private extension command):

```
static int
gtp_countlib(char *s)
{
    int i, j;
    if (!gtp_decode_coord(s, &i, &j))
        return gtp_failure("invalid coordinate");

    if (BOARD(i, j) == EMPTY)
        return gtp_failure("vertex must not be empty");

    return gtp_success("%d", countlib(POS(i, j)));
}
```

The arguments to the command are passed in the string `s`. In this case we expect a vertex as argument and thus try to read it with `gtp_decode_coord()` from `'gtp.c'`.

A correctly formatted response should start with either '=' or '?', followed by the identity number (if one was sent), the actual result, and finally two consecutive newlines. It is important to get this formatting correct since the controller in the other end relies on it. Naturally the result itself cannot contain two consecutive newlines but it may be split over several lines by single newlines.

The easiest way to generate a correctly formatted response is with one of the functions `gtp_failure()` and `gtp_success()`, assuming that their formatted output does not end with a newline.

Sometimes the output is too complex for use with `gtp_success`, e.g. if we want to print vertices, which `gtp_success()` does not support. Then we have to fall back to the construction in e.g. `gtp_genmove()`:

```
static int
gtp_genmove(char *s)
{
    [...]
    gtp_start_response(GTP_SUCCESS);
    gtp_print_vertex(i, j);
    return gtp_finish_response();
}
```

Here `gtp_start_response()` writes the equal sign and the identity number while `gtp_finish_response()` adds the final two newlines. The next example is from `gtp_list_commands()`:

```
static int
gtp_list_commands(char *s)
{
    int k;
    UNUSED(s);

    gtp_start_response(GTP_SUCCESS);
```

```

    for (k = 0; commands[k].name != NULL; k++)
        gtp_printf("%s\n", commands[k].name);

    gtp_printf("\n");
    return GTP_OK;
}

```

As we have said, the response should be finished with two newlines. Here we have to finish up the response ourselves since we already have one newline in place from the last command printed in the loop.

In order to add a new GTP command to GNU Go, the following pieces of code need to be inserted in ‘play_gtp.c’:

1. A function declaration using the DECLARE macro in the list starting at line 68.
2. An entry in the `commands[]` array starting at line 200.
3. An implementation of the function handling the command.

Useful helper functions in ‘gtp.c’/‘gtp.h’ are:

- `gtp_printf()` for basic formatted printing.
- `gtp_mprintf()` for printing with special format codes for vertices and colors.
- `gtp_success()` and `gtp_failure()` for simple responses.
- `gtp_start_response()` and `gtp_end_response()` for more complex responses.
- `gtp_print_vertex()` and `gtp_print_vertices()` for printing one or multiple vertices.
- `gtp_decode_color()` to read in a color from the command arguments.
- `gtp_decode_coord()` to read in a vertex from the command arguments.
- `gtp_decode_move()` to read in a move, i.e. color plus vertex, from the command arguments.

19.6 GTP command reference

This section lists the GTP commands implemented in GNU Go along with some information about each command. Each entry in the list has the following fields:

- **Function:** What this command does.
- **Arguments:** What other information, if any, this command requires. Typical values include *none* or *vertex* or *integer* (there are others).
- **Fails:** Circumstances which cause this command to fail.
- **Returns:** What is displayed after the = and before the two newlines. Typical values include *nothing* or *a move coordinate* or some status string (there are others).
- **Status:** How this command relates to the standard GTP version 2 commands. If nothing else is specified it is a GNU Go private extension.

Without further ado, here is the big list (in no particular order).

Note: if new commands are added by editing ‘interface/play_gtp.c’ this list could become incomplete. You may rebuild this list in ‘doc/gtp-commands.texi’ with the command `make gtp-commands` in the ‘doc/’ directory. This may require GNU sed.

- quit: Quit
 - Arguments: none
 - Fails: never
 - Returns: nothing

Status: GTP version 2 standard command.
- protocol_version: Report protocol version.
 - Arguments: none
 - Fails: never
 - Returns: protocol version number

Status: GTP version 2 standard command.
- name: Report the name of the program.
 - Arguments: none
 - Fails: never
 - Returns: program name

Status: GTP version 2 standard command.
- version: Report the version number of the program.
 - Arguments: none
 - Fails: never
 - Returns: version number

Status: GTP version 2 standard command.
- boardsize: Set the board size to NxN and clear the board.
 - Arguments: integer
 - Fails: board size outside engine's limits
 - Returns: nothing

Status: GTP version 2 standard command.
- query_boardsize: Find the current boardsize
 - Arguments: none
 - Fails: never
 - Returns: board_size
- clear_board: Clear the board.
 - Arguments: none
 - Fails: never
 - Returns: nothing

Status: GTP version 2 standard command.
- orientation: Set the orientation to N and clear the board
 - Arguments: integer
 - Fails: illegal orientation
 - Returns: nothing

- `query_orientation`: Find the current orientation
Arguments: none
Fails: never
Returns: orientation
- `komi`: Set the komi.
Arguments: float
Fails: incorrect argument
Returns: nothing

Status: GTP version 2 standard command.
- `get_komi`: Get the komi
Arguments: none
Fails: never
Returns: Komi
- `black`: Play a black stone at the given vertex.
Arguments: vertex
Fails: invalid vertex, illegal move
Returns: nothing

Status: Obsolete GTP version 1 command.
- `playwhite`: Play a white stone at the given vertex.
Arguments: vertex
Fails: invalid vertex, illegal move
Returns: nothing

Status: Obsolete GTP version 1 command.
- `play`: Play a stone of the given color at the given vertex.
Arguments: color, vertex
Fails: invalid vertex, illegal move
Returns: nothing

Status: GTP version 2 standard command.
- `fixed_handicap`: Set up fixed placement handicap stones.
Arguments: number of handicap stones
Fails: invalid number of stones for the current boardsize
Returns: list of vertices with handicap stones

Status: GTP version 2 standard command.
- `place_free_handicap`: Choose free placement handicap stones and put them on the board.
Arguments: number of handicap stones
Fails: invalid number of stones
Returns: list of vertices with handicap stones

Status: GTP version 2 standard command.

- `set_free_handicap`: Put free placement handicap stones on the board.

Arguments: list of vertices with handicap stones

Fails: board not empty, bad list of vertices

Returns: nothing

Status: GTP version 2 standard command.

- `get_handicap`: Get the handicap

Arguments: none

Fails: never

Returns: handicap

- `loadsgf`: Load an sgf file, possibly up to a move number or the first occurrence of a move.

Arguments: filename + move number, vertex, or nothing

Fails: missing filename or failure to open or parse file

Returns: color to play

Status: GTP version 2 standard command.

- `color`: Return the color at a vertex.

Arguments: vertex

Fails: invalid vertex

Returns: "black", "white", or "empty"

- `list_stones`: List vertices with either black or white stones.

Arguments: color

Fails: invalid color

Returns: list of vertices

- `countlib`: Count number of liberties for the string at a vertex.

Arguments: vertex

Fails: invalid vertex, empty vertex

Returns: Number of liberties.

- `findlib`: Return the positions of the liberties for the string at a vertex.

Arguments: vertex

Fails: invalid vertex, empty vertex

Returns: Sorted space separated list of vertices.

- `accuratelib`: Determine which liberties a stone of given color will get if played at given vertex.

Arguments: move (color + vertex)

Fails: invalid color, invalid vertex, occupied vertex

Returns: Sorted space separated list of liberties

- `accurate_approxlib`: Determine which liberties a stone of given color will get if played at given vertex.

Arguments: move (color + vertex)

Fails: invalid color, invalid vertex, occupied vertex

Returns: Sorted space separated list of liberties

Supposedly identical in behavior to the above function and can be retired when this is confirmed.

- `is_legal`: Tell whether a move is legal.

Arguments: move
 Fails: invalid move
 Returns: 1 if the move is legal, 0 if it is not.
- `all_legal`: List all legal moves for either color.

Arguments: color
 Fails: invalid color
 Returns: Sorted space separated list of vertices.
- `captures`: List the number of captures taken by either color.

Arguments: color
 Fails: invalid color
 Returns: Number of captures.
- `last_move`: Return the last move.

Arguments: none
 Fails: no previous move known
 Returns: Color and vertex of last move.
- `move_history`: Print the move history in reverse order

Arguments: none
 Fails: never
 Returns: List of moves played in reverse order in format:
 color move (one move per line)
- `invariant_hash`: Return the rotation/reflection invariant board hash.

Arguments: none
 Fails: never
 Returns: Invariant hash for the board as a hexadecimal number.
- `invariant_hash_for_moves`: Return the rotation/reflection invariant board hash obtained by playing all the possible moves for the given color.

Arguments: color
 Fails: invalid color
 Returns: List of moves + invariant hash as a hexadecimal number,
 one pair of move + hash per line.
- `trymove`: Play a stone of the given color at the given vertex.

Arguments: move (color + vertex)
 Fails: invalid color, invalid vertex, illegal move
 Returns: nothing
- `tryko`: Play a stone of the given color at the given vertex, allowing illegal ko capture.

Arguments: move (color + vertex)
 Fails: invalid color, invalid vertex, illegal move
 Returns: nothing

- popgo: Undo a trymove or tryko.
Arguments: none
Fails: stack empty
Returns: nothing
- clear_cache: clear the caches.
Arguments: none.
Fails: never.
Returns: nothing.
- attack: Try to attack a string.
Arguments: vertex
Fails: invalid vertex, empty vertex
Returns: attack code followed by attack point if attack code nonzero.
- attack_either: Try to attack either of two strings
Arguments: two vertices
Fails: invalid vertex, empty vertex
Returns: attack code against the strings. Guarantees there exists a move which will attack one of the two with attack_code, but does not return the move.
- defend: Try to defend a string.
Arguments: vertex
Fails: invalid vertex, empty vertex
Returns: defense code followed by defense point if defense code nonzero.
- does_attack: Examine whether a specific move attacks a string tactically.
Arguments: vertex (move), vertex (dragon)
Fails: invalid vertex, empty vertex
Returns: attack code
- does_defend: Examine whether a specific move defends a string tactically.
Arguments: vertex (move), vertex (dragon)
Fails: invalid vertex, empty vertex
Returns: attack code
- ladder_attack: Try to attack a string strictly in a ladder.
Arguments: vertex
Fails: invalid vertex, empty vertex
Returns: attack code followed by attack point if attack code nonzero.
- increase_depths: Increase depth values by one.
Arguments: none
Fails: never
Returns: nothing
- decrease_depths: Decrease depth values by one.
Arguments: none
Fails: never
Returns: nothing
- owl_attack: Try to attack a dragon.

- Arguments: vertex
Fails: invalid vertex, empty vertex
Returns: attack code followed by attack point if attack code nonzero.
- owl_defend: Try to defend a dragon.
Arguments: vertex
Fails: invalid vertex, empty vertex
Returns: defense code followed by defense point if defense code nonzero.
- owl_threaten_attack: Try to attack a dragon in 2 moves.
Arguments: vertex
Fails: invalid vertex, empty vertex
Returns: attack code followed by the two attack points if attack code nonzero.
- owl_threaten_defense: Try to defend a dragon with 2 moves.
Arguments: vertex
Fails: invalid vertex, empty vertex
Returns: defense code followed by the 2 defense points if defense code nonzero.
- owl_does_attack: Examine whether a specific move attacks a dragon.
Arguments: vertex (move), vertex (dragon)
Fails: invalid vertex, empty vertex
Returns: attack code
- owl_does_defend: Examine whether a specific move defends a dragon.
Arguments: vertex (move), vertex (dragon)
Fails: invalid vertex, empty vertex
Returns: defense code
- owl_connection_defends: Examine whether a connection defends involved dragons.
Arguments: vertex (move), vertex (dragon1), vertex (dragon2)
Fails: invalid vertex, empty vertex
Returns: defense code
- defend_both: Try to defend both of two strings
Arguments: two vertices
Fails: invalid vertex, empty vertex
Returns: defend code for the strings. Guarantees there exists a move which will defend both of the two with defend_code, but does not return the move.
- owl_substantial: Determine whether capturing a string gives a living dragon
Arguments: vertex
Fails: invalid vertex, empty vertex
Returns: 1 if dragon can live, 0 otherwise
- analyze_semeai: Analyze a semeai
Arguments: dragona, dragonb
Fails: invalid vertices, empty vertices
Returns: semeai defense result, semeai attack result, semeai move

- `analyze_semeai_after_move`: Analyze a semeai after a move have been made.
Arguments: `color`, `vertex`, `dragona`, `dragonb`
Fails: `invalid vertices`
Returns: `semeai defense result`, `semeai attack result`, `semeai move`
- `tactical_analyze_semeai`: Analyze a semeai, not using owl
Arguments: `dragona`, `dragonb`
Fails: `invalid vertices`, `empty vertices`
Returns: `status of dragona`, `dragonb assuming dragona moves first`
- `connect`: Try to connect two strings.
Arguments: `vertex`, `vertex`
Fails: `invalid vertex`, `empty vertex`, `vertices of different colors`
Returns: `connect result followed by connect point if successful`.
- `disconnect`: Try to disconnect two strings.
Arguments: `vertex`, `vertex`
Fails: `invalid vertex`, `empty vertex`, `vertices of different colors`
Returns: `disconnect result followed by disconnect point if successful`.
- `break_in`: Try to break from string into area.
Arguments: `vertex`, `vertices`
Fails: `invalid vertex`, `empty vertex`.
Returns: `result followed by break in point if successful`.
- `block_off`: Try to block string from area.
Arguments: `vertex`, `vertices`
Fails: `invalid vertex`, `empty vertex`.
Returns: `result followed by block point if successful`.
- `eval_eye`: Evaluate an eye space
Arguments: `vertex`
Fails: `invalid vertex`
Returns: `Minimum and maximum number of eyes`. If these differ an `attack` and a `defense point` are additionally returned. If the `vertex` is not an eye space or not of unique color, a single `-1` is returned.
- `dragon_status`: Determine status of a dragon.
Arguments: `optional vertex`
Fails: `invalid vertex`, `empty vertex`
Returns: `status ("alive", "critical", "dead", or "unknown")`, `attack point`, `defense point`. Points of attack and defense are only given if the status is `critical`. If no `vertex` is given, the status is listed for all dragons, one per row in the format `"A4: alive"`.

FIXME: Should be able to distinguish between life in seki and independent life. Should also be able to identify ko.
- `same_dragon`: Determine whether two stones belong to the same dragon.

Arguments: vertex, vertex
 Fails: invalid vertex, empty vertex
 Returns: 1 if the vertices belong to the same dragon, 0 otherwise

- unconditional_status: Determine the unconditional status of a vertex.

Arguments: vertex
 Fails: invalid vertex
 Returns: unconditional status ("undecided", "alive", "dead", "white_territory", "black_territory"). Occupied vertices can be undecided, alive, or dead. Empty vertices can be undecided, white territory, or black territory.

- combination_attack: Find a move by color capturing something through a combination attack.

Arguments: color
 Fails: invalid color
 Returns: Recommended move, PASS if no move found

- combination_defend: If color can capture something through a combination attack, list moves by the opponent of color to defend against this attack.

Arguments: color
 Fails: invalid color
 Returns: Recommended moves, PASS if no combination attack found.

- aa_confirm_safety: Run atari_atari_confirm_safety().

Arguments: move, optional int
 Fails: invalid move
 Returns: success code, if failure also defending move

- genmove_black: Generate and play the supposedly best black move.

Arguments: none
 Fails: never
 Returns: a move coordinate or "PASS"

Status: Obsolete GTP version 1 command.

- genmove_white: Generate and play the supposedly best white move.

Arguments: none
 Fails: never
 Returns: a move coordinate or "PASS"

Status: Obsolete GTP version 1 command.

- genmove: Generate and play the supposedly best move for either color.

Arguments: color to move
 Fails: invalid color
 Returns: a move coordinate or "PASS" (or "resign" if resignation_allowed)

Status: GTP version 2 standard command.

- reg_genmove: Generate the supposedly best move for either color.

Arguments: color to move
 Fails: invalid color
 Returns: a move coordinate (or "PASS")

Status: GTP version 2 standard command.

- gg_genmove: Generate the supposedly best move for either color.

Arguments: color to move, optionally a random seed
 Fails: invalid color
 Returns: a move coordinate (or "PASS")

This differs from reg_genmove in the optional random seed.

- restricted_genmove: Generate the supposedly best move for either color from a choice of allowed vertices.

Arguments: color to move, allowed vertices
 Fails: invalid color, invalid vertex, no vertex listed
 Returns: a move coordinate (or "PASS")

- kgs_genmove_cleanup: Generate and play the supposedly best move for either color, not passing until all dead opponent stones have been removed.

Arguments: color to move
 Fails: invalid color
 Returns: a move coordinate (or "PASS")

Status: KGS specific command.

A similar command, but possibly somewhat different, will likely be added to GTP version 3 at a later time.

- level: Set the playing level.

Arguments: int
 Fails: incorrect argument
 Returns: nothing

- undo: Undo one move

Arguments: none
 Fails: If move history is too short.
 Returns: nothing

Status: GTP version 2 standard command.

- gg_undo: Undo a number of moves

Arguments: optional int
 Fails: If move history is too short.
 Returns: nothing

- time_settings: Set time allowance

Arguments: int main_time, int byo_yomi_time, int byo_yomi_stones
 Fails: syntax error
 Returns: nothing

- Status: GTP version 2 standard command.
- `time_left`: Report remaining time

Arguments: color color, int time, int stones

Fails: syntax error

Returns: nothing
- Status: GTP version 2 standard command.
- `final_score`: Compute the score of a finished game.

Arguments: Optional random seed

Fails: never

Returns: Score in SGF format (RE property).
- Status: GTP version 2 standard command.
- `final_status`: Report the final status of a vertex in a finished game.

Arguments: Vertex, optional random seed

Fails: invalid vertex

Returns: Status in the form of one of the strings "alive", "dead", "seki", "white_territory", "black_territory", or "dame".
 - `final_status_list`: Report vertices with a specific final status in a finished game.

Arguments: Status in the form of one of the strings "alive", "dead", "seki", "white_territory", "black_territory", or "dame".
An optional random seed can be added.

Fails: missing or invalid status string

Returns: Vertices having the specified status. These are split with one string on each line if the vertices are nonempty (i.e. for "alive", "dead", and "seki").
- Status: GTP version 2 standard command.
However, "dame", "white_territory", and "black_territory" are private extensions.
- `estimate_score`: Estimate the score

Arguments: None

Fails: never

Returns: upper and lower bounds for the score
 - `experimental_score`: Estimate the score, taking into account which player moves next

Arguments: Color to play

Fails: Invalid color

Returns: Score.

This function generates a move for color, then adds the value of the move generated to the value of the position. Critical dragons are awarded to the opponent since the value of rescuing a critical dragon is taken into account in the value of the move generated.

- `reset_life_node_counter`: Reset the count of life nodes.
Arguments: none
Fails: never
Returns: nothing

Note: This function is obsolete and only remains for backwards compatibility.
- `get_life_node_counter`: Retrieve the count of life nodes.
Arguments: none
Fails: never
Returns: number of life nodes

Note: This function is obsolete and only remains for backwards compatibility.
- `reset_owl_node_counter`: Reset the count of owl nodes.
Arguments: none
Fails: never
Returns: nothing
- `get_owl_node_counter`: Retrieve the count of owl nodes.
Arguments: none
Fails: never
Returns: number of owl nodes
- `reset_reading_node_counter`: Reset the count of reading nodes.
Arguments: none
Fails: never
Returns: nothing
- `get_reading_node_counter`: Retrieve the count of reading nodes.
Arguments: none
Fails: never
Returns: number of reading nodes
- `reset_trymove_counter`: Reset the count of trymoves/trykos.
Arguments: none
Fails: never
Returns: nothing
- `get_trymove_counter`: Retrieve the count of trymoves/trykos.
Arguments: none
Fails: never
Returns: number of trymoves/trykos
- `reset_connection_node_counter`: Reset the count of connection nodes.
Arguments: none
Fails: never
Returns: nothing
- `get_connection_node_counter`: Retrieve the count of connection nodes.

- Arguments: none
 Fails: never
 Returns: number of connection nodes
- test_eyeshape: Test an eyeshape for inconsistent evaluations
 Arguments: Eyeshape vertices
 Fails: Bad vertices
 Returns: Failure reports on stderr.
 - analyze_eyegraph: Compute an eyevalue and vital points for an eye graph
 Arguments: Eyeshape encoded in string
 Fails: Bad eyeshape, analysis failed
 Returns: Eyevalue, vital points
 - cputime: Returns elapsed CPU time in seconds.
 Arguments: none
 Fails: never
 Returns: Total elapsed (user + system) CPU time in seconds.
 - showboard: Write the position to stdout.
 Arguments: none
 Fails: never
 Returns: nothing
- Status: GTP version 2 standard command.
- dump_stack: Dump stack to stderr.
 Arguments: none
 Fails: never
 Returns: nothing
 - initial_influence: Return information about the initial influence function.
 Arguments: color to move, what information
 Fails: never
 Returns: Influence data formatted like:
- ```

0.51 1.34 3.20 6.60 9.09 8.06 1.96 0.00 0.00
0.45 1.65 4.92 12.19 17.47 15.92 4.03 0.00 0.00
 .
 .
 .
0.00 0.00 0.00 0.00 0.00 100.00 75.53 41.47 23.41

```

The available choices of information are:

```

white_influence (float)
black_influence (float)
white_strength (float)
black_strength (float)
white_attenuation (float)

```

```

black_attenuation (float)
white_permeability (float)
black_permeability (float)
territory_value (float)
influence_regions (int)
non_territory (int)

```

The encoding of `influence_regions` is as follows:

```

4 white stone
3 white territory
2 white moyo
1 white area
0 neutral
-1 black area
-2 black moyo
-3 black territory
-4 black stone

```

- `move_influence`: Return information about the influence function after a move.
 

Arguments: `move`, what information

Fails: `never`

Returns: Influence data formatted like for `initial_influence`.
- `move_probabilities`: List probabilities of each move being played (when non-zero). If no previous `genmove` command has been issued, the result of this command will be meaningless.
 

Arguments: `none`

Fails: `never`

Returns: Move, probability pairs, one per row.
- `move_uncertainty`: Return the number of bits of uncertainty in the move. If no previous `genmove` command has been issued, the result of this command will be meaningless.
 

Arguments: `none`

Fails: `never`

Returns: bits of uncertainty
- `followup_influence`: Return information about the followup influence after a move.
 

Arguments: `move`, what information

Fails: `never`

Returns: Influence data formatted like for `initial_influence`.
- `worm_data`: Return the information in the worm data structure.
 

Arguments: optional `vertex`

Fails: `never`

Returns: Worm data formatted like:

```

A19:
color black
size 10
effective_size 17.83

```

```

origin A19
liberties 8
liberties2 15
liberties3 10
liberties4 8
attack PASS
attack_code 0
lunch B19
defend PASS
defend_code 0
cutstone 2
cutstone2 0
genus 0
inessential 0
B19:
color white
.
.
.
inessential 0
C19:
...

```

If an intersection is specified, only data for this one will be returned.

- `worm_stones`: List the stones of a worm  
Arguments: the location, "BLACK" or "WHITE"  
Fails: if called on an empty or off-board location  
Returns: list of stones
- `worm_cutstone`: Return the cutstone field in the worm data structure.  
Arguments: non-empty vertex  
Fails: never  
Returns: cutstone
- `dragon_data`: Return the information in the dragon data structure.  
Arguments: optional intersection  
Fails: never  
Returns: Dragon data formatted in the corresponding way to `worm_data`.
- `dragon_stones`: List the stones of a dragon  
Arguments: the location  
Fails: if called on an empty or off-board location  
Returns: list of stones
- `eye_data`: Return the information in the eye data structure.  
Arguments: color, vertex  
Fails: never  
Returns: eye data fields and values, one pair per row
- `half_eye_data`: Return the information in the half eye data structure.

Arguments: vertex  
 Fails: never  
 Returns: half eye data fields and values, one pair per row

- start\_sgftrace: Start storing moves executed during reading in an sgf tree in memory.

Arguments: none  
 Fails: never  
 Returns: nothing

Warning: You had better know what you're doing if you try to use this command.

- finish\_sgftrace: Finish storing moves in an sgf tree and write it to file.

Arguments: filename  
 Fails: never  
 Returns: nothing

Warning: You had better know what you're doing if you try to use this command.

- printsgf: Dump the current position as a static sgf file to filename, or as output if filename is missing or "-"

Arguments: optional filename  
 Fails: never  
 Returns: nothing if filename, otherwise the sgf

- tune\_move\_ordering: Tune the parameters for the move ordering in the tactical reading.

Arguments: MOVE\_ORDERING\_PARAMETERS integers  
 Fails: incorrect arguments  
 Returns: nothing

- echo: Echo the parameter

Arguments: string  
 Fails: never  
 Returns: nothing

- echo\_err: Echo the parameter to stdout AND stderr

Arguments: string  
 Fails: never  
 Returns: nothing

- help: List all known commands

Arguments: none  
 Fails: never  
 Returns: list of known commands, one per line

Status: GTP version 2 standard command.

- known\_command: Tell whether a command is known.

Arguments: command name  
 Fails: never

Returns: "true" if command exists, "false" if not

Status: GTP version 2 standard command.

- report\_uncertainty: Turn uncertainty reports from owl\_attack and owl\_defend on or off.
 

Arguments: "on" or "off"  
 Fails: invalid argument  
 Returns: nothing
- get\_random\_seed: Get the random seed
 

Arguments: none  
 Fails: never  
 Returns: random seed
- set\_random\_seed: Set the random seed
 

Arguments: integer  
 Fails: invalid data  
 Returns: nothing
- advance\_random\_seed: Advance the random seed by a number of games.
 

Arguments: integer  
 Fails: invalid data  
 Returns: New random seed.
- is\_surrounded: Determine if a dragon is surrounded
 

Arguments: vertex (dragon)  
 Fails: invalid vertex, empty vertex  
 Returns: 1 if surrounded, 2 if weakly surrounded, 0 if not
- does\_surround: Determine if a move surrounds a dragon
 

Arguments: vertex (move), vertex (dragon)  
 Fails: invalid vertex, empty (dragon, nonempty (move))  
 Returns: 1 if (move) surrounds (dragon)
- surround\_map: Report the surround map for dragon at a vertex
 

Arguments: vertex (dragon), vertex (mapped location)  
 Fails: invalid vertex, empty dragon  
 Returns: value of surround map at (mapped location), or -1 if dragon not surrounded.
- set\_search\_diamond: limit search, and establish a search diamond
 

Arguments: pos  
 Fails: invalid value  
 Returns: nothing
- reset\_search\_mask: unmark the entire board for limited search
 

Arguments: none  
 Fails: never  
 Returns: nothing
- limit\_search: sets the global variable limit\_search



Arguments: value  
Fails: invalid arguments  
Returns: nothing

- `set_search_limit`: mark a vertex for limited search

Arguments: position  
Fails: invalid arguments  
Returns: nothing

- `draw_search_area`: Draw search area. Writes to `stderr`.

Arguments: none  
Fails: never  
Returns: nothing

## 20 Regression testing

The standard purpose of regression testing is to avoid getting the same bug twice. When a bug is found, the programmer fixes the bug and adds a test to the test suite. The test should fail before the fix and pass after the fix. When a new version is about to be released, all the tests in the regression test suite are run and if an old bug reappears, this will be seen quickly since the appropriate test will fail.

The regression testing in GNU Go is slightly different. A typical test case involves specifying a position and asking the engine what move it would make. This is compared to one or more correct moves to decide whether the test case passes or fails. It is also stored whether a test case is expected to pass or fail, and deviations in this status signify whether a change has solved some problem and/or broken something else. Thus the regression tests both include positions highlighting some mistake being done by the engine, which are waiting to be fixed, and positions where the engine does the right thing, where we want to detect if a change breaks something.

### 20.1 Regression testing in GNU Go

Regression testing is performed by the files in the `'regression/'` directory. The tests are specified as GTP commands in files with the suffix `'.tst'`, with corresponding correct results and expected pass/fail status encoded in GTP comments following the test. To run a test suite the shell scripts `'test.sh'`, `'eval.sh'`, and `'regress.sh'` can be used. There are also Makefile targets to do this. If you make `all_batches` most of the tests are run. The Pike script `'regress.pike'` can also be used to run all tests or a subset of the tests.

Game records used by the regression tests are stored in the directory `'regression/games/'` and its subdirectories.

### 20.2 Test suites

The regression tests are grouped into suites and stored in files as GTP commands. A part of a test suite can look as follows:

```
Connecting with ko at B14 looks best. Cutting at D17 might be
considered. B17 (game move) is inferior.
loadsgf games/strategy25.sgf 61
90 gg_genmove black
#? [B14|D17]

The game move at P13 is a suicidal blunder.
loadsgf games/strategy25.sgf 249
95 gg_genmove black
#? [!P13]

loadsgf games/strategy26.sgf 257
100 gg_genmove black
#? [M16]*
```

Lines starting with a hash sign, or in general anything following a hash sign, are interpreted as comments by the GTP mode and thus ignored by the engine. GTP commands

are executed in the order they appear, but only those on numbered lines are used for testing. The comment lines starting with `#?` are magical to the regression testing scripts and indicate correct results and expected pass/fail status. The string within brackets is matched as a regular expression against the response from the previous numbered GTP command. A particular useful feature of regular expressions is that by using `|` it is possible to specify alternatives. Thus `B14|D17` above means that if either B14 or D17 is the move generated in test case 90, it passes. There is one important special case to be aware of. If the correct result string starts with an exclamation mark, this is excluded from the regular expression but afterwards the result of the matching is negated. Thus `!P13` in test case 95 means that any move except P13 is accepted as a correct result.

In test case 100, the brackets on the `#?` line is followed by an asterisk. This means that the test is expected to fail. If there is no asterisk, the test is expected to pass. The brackets may also be followed by a `&`, meaning that the result is ignored. This is primarily used to report statistics, e.g. how many tactical reading nodes were spent while running the test suite.

### 20.3 Running the Regression Tests

`./test.sh blunder.tst` runs the tests in `'blunder.tst'` and prints the results of the commands on numbered lines, which may look like:

```

1 E5
2 F9
3 018
4 B7
5 A4
6 E4
7 E3
8 A3
9 D9
10 J9
11 B3
12 C6
13 C6

```

This is usually not very informative, however. More interesting is `./eval.sh blunder.tst` which also compares the results above against the correct ones in the test file and prints a report for each test on the form:

```

1 failed: Correct '!E5', got 'E5'
2 failed: Correct 'C9|H9', got 'F9'
3 PASSED
4 failed: Correct 'B5|C5|C4|D4|E4|E3|F3', got 'B7'
5 PASSED
6 failed: Correct 'D4', got 'E4'
7 PASSED
8 failed: Correct 'B4', got 'A3'
9 failed: Correct 'G8|G9|H8', got 'D9'
10 failed: Correct 'G9|F9|C7', got 'J9'

```

```

11 failed: Correct 'D4|E4|E5|F4|C6', got 'B3'
12 failed: Correct 'D4', got 'C6'
13 failed: Correct 'D4|E4|E5|F4', got 'C6'

```

The result of a test can be one of four different cases:

- **passed:** An expected pass  
This is the ideal result.
- **PASSED:** An unexpected pass  
This is a result that we are hoping for when we fix a bug. An old test case that used to fail is now passing.
- **failed:** An expected failure  
The test failed but this was also what we expected, unless we were trying to fix the particular mistake highlighted by the test case. These tests show weaknesses of the GNU Go engine and are good places to search if you want to detect an area which needs improvement.
- **FAILED:** An unexpected failure  
This should nominally only happen if something is broken by a change. However, sometimes GNU Go passes a test, but for the wrong reason or for a combination of wrong reasons. When one of these reasons is fixed, the other one may shine through so that the test suddenly fails. When a test case unexpectedly fails, it is necessary to make a closer examination in order to determine whether a change has broken something.

If you want a less verbose report, `./regress.sh . blunder.tst` does the same thing as the previous command, but only reports unexpected results. The example above is compressed to

```

3 unexpected PASS!
5 unexpected PASS!
7 unexpected PASS!

```

For convenience the tests are also available as makefile targets. For example, `make blunder` runs the tests in the blunder test suite by executing `eval.sh blunder.tst`. `make all_batches` runs all test suites in a sequence using the `regress.sh` script.

## 20.4 Running regress.pike

A more powerful way to run regressions is with the script `'regress.pike'`. This requires that you have Pike (<http://pike.ida.liu.se>) installed.

Executing `./regress.pike` without arguments will run all testsuites that `make all_batches` would run. The difference is that unexpected results are reported immediately when they have been found (instead of after the whole file has been run) and that statistics of time consumption and node usage is presented for each test file and in total.

To run a single test suite do e.g. `./regress.pike nicklas3.tst` or `./regress.pike nicklas3`. The result may look like:

```

nicklas3 2.96 614772 3322 469
Total nodes: 614772 3322 469
Total time: 2.96 (3.22)
Total uncertainty: 0.00

```

The numbers here mean that the test suite took 2.96 seconds of processor time and 3.22 seconds of real time. The consumption of reading nodes was 614772 for tactical reading, 3322 for owl reading, and 469 for connection reading. The last line relates to the variability of the generated moves in the test suite, and 0 means that none was decided by the randomness contribution to the move valuation. Multiple testsuites can be run by e.g. `./regress.pike owl ld_owl owl1`.

It is also possible to run a single testcase, e.g. `./regress.pike strategy:6`, a number of testcases, e.g. `./regress.pike strategy:6,23,45`, a range of testcases, e.g. `./regress.pike strategy:13-15` or more complex combinations e.g. `./regress.pike strategy:6,13-15,23,45 nicklas3:602,1403`.

There are also command line options to choose what engine to run, what options to send to the engine, to turn on verbose output, and to use a file to specify which testcases to run. Run `./regress.pike --help` for a complete and up to date list of options.

## 20.5 Viewing tests with Emacs

To get a quick regression view, you may use the graphical display mode available with Emacs (see [Section 3.5 \[Emacs\], page 13](#)). You will want the cursor in the regression buffer when you enter `M-x gnugo`, so that GNU Go opens in the correct directory. A good way to be in the right directory is to open the window of the test you want to investigate. Then you can cut and past GTP commands directly from the test to the minibuffer, using the `:` command from Emacs. Although Emacs mode does not have a coordinate grid, you may get an ascii board with the coordinate grid using `: showboard` command.

## 20.6 HTML Regression Views

Extremely useful HTML Views of the regression tests may be produced using two perl scripts `regression/regress.pl` and `regression/regress.plx`.

1. The driver program (`regress.pl`) which:
  - Runs the regression tests, invoking GNU Go.
  - Captures the trace output, board position, and pass/fail status, sgf output, and dragon status information.
2. The interface to view the captured output (`regress.plx`) which:
  - Never invokes GNU Go.
  - Displays the captured output in helpful formats (i.e. HTML).

### 20.6.1 Setting up the HTML regression Views

There are many ways configuring Apache to permit CGI scripts, all of them are featured in Apache documentation, which can be found at <http://httpd.apache.org/docs/2.0/howto/cgi.html>

Below you will find one example.

This documentation assumes an Apache 2.0 included in Fedora Core distribution, but it should be fairly close to the config for other distributions.

First, you will need to configure Apache to run CGI scripts in the directory you wish to serve the html views from. In `/etc/httpd/conf/httpd.conf` there should be a line:

```
DocumentRoot "/var/www/html"
```

Search for a line `<Directory "/path/to/directory">`, where `/path/to/directory` is the same as provided in `DocumentRoot`, then add `ExecCGI` to list of `Options`. The whole section should look like:

```
<Directory "/var/www/html">
...
 Options ... ExecCGI
...
</Directory>
```

This allows CGI scripts to be executed in the directory used by `regress.plx`. Next, you need to tell Apache that `.plx` is a CGI script ending. Your `httpd.conf` file should contain a line:

```
AddHandler cgi-script ...
```

If there isn't already, add it; add `.plx` to the list of extensions, so line should look like:

```
AddHandler cgi-scriptplx
```

You will also need to make sure you have the necessary modules loaded to run CGI scripts; `mod_cgi` and `mod_mime` should be sufficient. Your `httpd.conf` should have the relevant `LoadModule cgi_module modules/mod_cgi.so` and `LoadModule mime_module modules/mod_mime.so` lines; uncomment them if necessary.

Next, you need to put a copy of `regress.plx` in the `DocumentRoot` directory `/var/www/html` or its subdirectories where you plan to serve the html views from.

You will also need to install the Perl module GD (<http://search.cpan.org/dist/GD/>), available from CPAN.

Finally, run `regression/regress.pl` to create the xml data used to generate the html views (to do all regression tests run `regression/regress.pl -a 1`); then, copy the `html/` directory to the same directory as `regress.plx` resides in.

At this point, you should have a working copy of the html regression views.

Additional notes for Debian users: The Perl GD module can be installed by `apt-get install libgd-perl`. It may suffice to add this to the `apache2` configuration:

```
<Directory "/var/www/regression">
Options +ExecCGI
AddHandler cgi-script .plx
RedirectMatch ^/regression$ /regression/regress.plx
</Directory>
```

and then make a link from `/var/www/regression` to the GNU Go regression directory. The `RedirectMatch` statement is only needed to set up a shorter entry URL.

## Appendix A Copying

The program GNU Go is distributed under the terms of the GNU General Public License (GPL). Its documentation is distributed under the terms of the GNU Free Documentation License (GFDL).

### A.1 GNU GENERAL PUBLIC LICENSE

Version 3, 29 June 2007

Copyright © 2007 Free Software Foundation, Inc. <<http://fsf.org/>>  
Everyone is permitted to copy and distribute verbatim copies  
of this license document, but changing it is not allowed.

#### Preamble

The GNU General Public License is a free, copyleft license for software and other kinds of works.

The licenses for most software and other practical works are designed to take away your freedom to share and change the works. By contrast, the GNU General Public License is intended to guarantee your freedom to share and change all versions of a program—to make sure it remains free software for all its users. We, the Free Software Foundation, use the GNU General Public License for most of our software; it applies also to any other work released this way by its authors. You can apply it to your programs, too.

When we speak of free software, we are referring to freedom, not price. Our General Public Licenses are designed to make sure that you have the freedom to distribute copies of free software (and charge for them if you wish), that you receive source code or can get it if you want it, that you can change the software or use pieces of it in new free programs, and that you know you can do these things.

To protect your rights, we need to prevent others from denying you these rights or asking you to surrender the rights. Therefore, you have certain responsibilities if you distribute copies of the software, or if you modify it: responsibilities to respect the freedom of others.

For example, if you distribute copies of such a program, whether gratis or for a fee, you must pass on to the recipients the same freedoms that you received. You must make sure that they, too, receive or can get the source code. And you must show them these terms so they know their rights.

Developers that use the GNU GPL protect your rights with two steps: (1) assert copyright on the software, and (2) offer you this License giving you legal permission to copy, distribute and/or modify it.

For the developers' and authors' protection, the GPL clearly explains that there is no warranty for this free software. For both users' and authors' sake, the GPL requires that modified versions be marked as changed, so that their problems will not be attributed erroneously to authors of previous versions.

Some devices are designed to deny users access to install or run modified versions of the software inside them, although the manufacturer can do so. This is fundamentally

incompatible with the aim of protecting users' freedom to change the software. The systematic pattern of such abuse occurs in the area of products for individuals to use, which is precisely where it is most unacceptable. Therefore, we have designed this version of the GPL to prohibit the practice for those products. If such problems arise substantially in other domains, we stand ready to extend this provision to those domains in future versions of the GPL, as needed to protect the freedom of users.

Finally, every program is threatened constantly by software patents. States should not allow patents to restrict development and use of software on general-purpose computers, but in those that do, we wish to avoid the special danger that patents applied to a free program could make it effectively proprietary. To prevent this, the GPL assures that patents cannot be used to render the program non-free.

The precise terms and conditions for copying, distribution and modification follow.

## TERMS AND CONDITIONS

### 0. DEFINITIONS

"This License" refers to version 3 of the GNU General Public License.

"Copyright" also means copyright-like laws that apply to other kinds of works, such as semiconductor masks.

"The Program" refers to any copyrightable work licensed under this License. Each licensee is addressed as "you". "Licensees" and "recipients" may be individuals or organizations.

To "modify" a work means to copy from or adapt all or part of the work in a fashion requiring copyright permission, other than the making of an exact copy. The resulting work is called a "modified version" of the earlier work or a work "based on" the earlier work.

A "covered work" means either the unmodified Program or a work based on the Program.

To "propagate" a work means to do anything with it that, without permission, would make you directly or secondarily liable for infringement under applicable copyright law, except executing it on a computer or modifying a private copy. Propagation includes copying, distribution (with or without modification), making available to the public, and in some countries other activities as well.

To "convey" a work means any kind of propagation that enables other parties to make or receive copies. Mere interaction with a user through a computer network, with no transfer of a copy, is not conveying.

An interactive user interface displays "Appropriate Legal Notices" to the extent that it includes a convenient and prominently visible feature that (1) displays an appropriate copyright notice, and (2) tells the user that there is no warranty for the work (except to the extent that warranties are provided), that licensees may convey the work under this License, and how to view a copy of this License. If the interface presents a list of user commands or options, such as a menu, a prominent item in the list meets this criterion.



## 1. SOURCE CODE

The "source code" for a work means the preferred form of the work for making modifications to it. "Object code" means any non-source form of a work.

A "Standard Interface" means an interface that either is an official standard defined by a recognized standards body, or, in the case of interfaces specified for a particular programming language, one that is widely used among developers working in that language.

The "System Libraries" of an executable work include anything, other than the work as a whole, that (a) is included in the normal form of packaging a Major Component, but which is not part of that Major Component, and (b) serves only to enable use of the work with that Major Component, or to implement a Standard Interface for which an implementation is available to the public in source code form. A "Major Component", in this context, means a major essential component (kernel, window system, and so on) of the specific operating system (if any) on which the executable work runs, or a compiler used to produce the work, or an object code interpreter used to run it.

The "Corresponding Source" for a work in object code form means all the source code needed to generate, install, and (for an executable work) run the object code and to modify the work, including scripts to control those activities. However, it does not include the work's System Libraries, or general-purpose tools or generally available free programs which are used unmodified in performing those activities but which are not part of the work. For example, Corresponding Source includes interface definition files associated with source files for the work, and the source code for shared libraries and dynamically linked subprograms that the work is specifically designed to require, such as by intimate data communication or control flow between those subprograms and other parts of the work.

The Corresponding Source need not include anything that users can regenerate automatically from other parts of the Corresponding Source.

The Corresponding Source for a work in source code form is that same work.

## 2. BASIC PERMISSIONS

All rights granted under this License are granted for the term of copyright on the Program, and are irrevocable provided the stated conditions are met. This License explicitly affirms your unlimited permission to run the unmodified Program. The output from running a covered work is covered by this License only if the output, given its content, constitutes a covered work. This License acknowledges your rights of fair use or other equivalent, as provided by copyright law.

You may make, run and propagate covered works that you do not convey, without conditions so long as your license otherwise remains in force. You may convey covered works to others for the sole purpose of having them make modifications exclusively for you, or provide you with facilities for running those works, provided that you comply with the terms of this License in conveying all material for which you do not control copyright. Those thus making or running the covered works for you must do so exclusively on your behalf, under your direction and control, on terms that prohibit them from making any copies of your copyrighted material outside their relationship with you.

Conveying under any other circumstances is permitted solely under the conditions stated below. Sublicensing is not allowed; section 10 makes it unnecessary.

### 3. PROTECTING USERS' LEGAL RIGHTS FROM ANTI-CIRCUMVENTION LAW

No covered work shall be deemed part of an effective technological measure under any applicable law fulfilling obligations under article 11 of the WIPO copyright treaty adopted on 20 December 1996, or similar laws prohibiting or restricting circumvention of such measures.

When you convey a covered work, you waive any legal power to forbid circumvention of technological measures to the extent such circumvention is effected by exercising rights under this License with respect to the covered work, and you disclaim any intention to limit operation or modification of the work as a means of enforcing, against the work's users, your or third parties' legal rights to forbid circumvention of technological measures.

### 4. CONVEYING VERBATIM COPIES

You may convey verbatim copies of the Program's source code as you receive it, in any medium, provided that you conspicuously and appropriately publish on each copy an appropriate copyright notice; keep intact all notices stating that this License and any non-permissive terms added in accord with section 7 apply to the code; keep intact all notices of the absence of any warranty; and give all recipients a copy of this License along with the Program.

You may charge any price or no price for each copy that you convey, and you may offer support or warranty protection for a fee.

### 5. CONVEYING MODIFIED SOURCE VERSIONS

You may convey a work based on the Program, or the modifications to produce it from the Program, in the form of source code under the terms of section 4, provided that you also meet all of these conditions:

- a) The work must carry prominent notices stating that you modified it, and giving a relevant date.
- b) The work must carry prominent notices stating that it is released under this License and any conditions added under section 7. This requirement modifies the requirement in section 4 to "keep intact all notices".
- c) You must license the entire work, as a whole, under this License to anyone who comes into possession of a copy. This License will therefore apply, along with any applicable section 7 additional terms, to the whole of the work, and all its parts, regardless of how they are packaged. This License gives no permission to license the work in any other way, but it does not invalidate such permission if you have separately received it.
- d) If the work has interactive user interfaces, each must display Appropriate Legal Notices; however, if the Program has interactive interfaces that do not display Appropriate Legal Notices, your work need not make them do so.

A compilation of a covered work with other separate and independent works, which are not by their nature extensions of the covered work, and which are not combined with it such as to form a larger program, in or on a volume of a storage or distribution

medium, is called an "aggregate" if the compilation and its resulting copyright are not used to limit the access or legal rights of the compilation's users beyond what the individual works permit. Inclusion of a covered work in an aggregate does not cause this License to apply to the other parts of the aggregate.

## 6. CONVEYING NON-SOURCE FORMS

You may convey a covered work in object code form under the terms of sections 4 and 5, provided that you also convey the machine-readable Corresponding Source under the terms of this License, in one of these ways:

a) Convey the object code in, or embodied in, a physical product (including a physical distribution medium), accompanied by the Corresponding Source fixed on a durable physical medium customarily used for software interchange.

b) Convey the object code in, or embodied in, a physical product (including a physical distribution medium), accompanied by a written offer, valid for at least three years and valid for as long as you offer spare parts or customer support for that product model, to give anyone who possesses the object code either (1) a copy of the Corresponding Source for all the software in the product that is covered by this License, on a durable physical medium customarily used for software interchange, for a price no more than your reasonable cost of physically performing this conveying of source, or (2) access to copy the Corresponding Source from a network server at no charge.

c) Convey individual copies of the object code with a copy of the written offer to provide the Corresponding Source. This alternative is allowed only occasionally and noncommercially, and only if you received the object code with such an offer, in accord with subsection 6b.

d) Convey the object code by offering access from a designated place (gratis or for a charge), and offer equivalent access to the Corresponding Source in the same way through the same place at no further charge. You need not require recipients to copy the Corresponding Source along with the object code. If the place to copy the object code is a network server, the Corresponding Source may be on a different server (operated by you or a third party) that supports equivalent copying facilities, provided you maintain clear directions next to the object code saying where to find the Corresponding Source. Regardless of what server hosts the Corresponding Source, you remain obligated to ensure that it is available for as long as needed to satisfy these requirements.

e) Convey the object code using peer-to-peer transmission, provided you inform other peers where the object code and Corresponding Source of the work are being offered to the general public at no charge under subsection 6d.

A separable portion of the object code, whose source code is excluded from the Corresponding Source as a System Library, need not be included in conveying the object code work.

A "User Product" is either (1) a "consumer product", which means any tangible personal property which is normally used for personal, family, or household purposes, or (2) anything designed or sold for incorporation into a dwelling. In determining whether a product is a consumer product, doubtful cases shall be resolved in favor of coverage. For a particular product received by a particular user, "normally used" refers to a typical or common use of that class of product, regardless of the status of the par-

ticular user or of the way in which the particular user actually uses, or expects or is expected to use, the product. A product is a consumer product regardless of whether the product has substantial commercial, industrial or non-consumer uses, unless such uses represent the only significant mode of use of the product.

"Installation Information" for a User Product means any methods, procedures, authorization keys, or other information required to install and execute modified versions of a covered work in that User Product from a modified version of its Corresponding Source. The information must suffice to ensure that the continued functioning of the modified object code is in no case prevented or interfered with solely because modification has been made.

If you convey an object code work under this section in, or with, or specifically for use in, a User Product, and the conveying occurs as part of a transaction in which the right of possession and use of the User Product is transferred to the recipient in perpetuity or for a fixed term (regardless of how the transaction is characterized), the Corresponding Source conveyed under this section must be accompanied by the Installation Information. But this requirement does not apply if neither you nor any third party retains the ability to install modified object code on the User Product (for example, the work has been installed in ROM).

The requirement to provide Installation Information does not include a requirement to continue to provide support service, warranty, or updates for a work that has been modified or installed by the recipient, or for the User Product in which it has been modified or installed. Access to a network may be denied when the modification itself materially and adversely affects the operation of the network or violates the rules and protocols for communication across the network.

Corresponding Source conveyed, and Installation Information provided, in accord with this section must be in a format that is publicly documented (and with an implementation available to the public in source code form), and must require no special password or key for unpacking, reading or copying.

## 7. ADDITIONAL TERMS

"Additional permissions" are terms that supplement the terms of this License by making exceptions from one or more of its conditions. Additional permissions that are applicable to the entire Program shall be treated as though they were included in this License, to the extent that they are valid under applicable law. If additional permissions apply only to part of the Program, that part may be used separately under those permissions, but the entire Program remains governed by this License without regard to the additional permissions.

When you convey a copy of a covered work, you may at your option remove any additional permissions from that copy, or from any part of it. (Additional permissions may be written to require their own removal in certain cases when you modify the work.) You may place additional permissions on material, added by you to a covered work, for which you have or can give appropriate copyright permission.

Notwithstanding any other provision of this License, for material you add to a covered work, you may (if authorized by the copyright holders of that material) supplement the terms of this License with terms:

- a) Disclaiming warranty or limiting liability differently from the terms of sections 15 and 16 of this License; or
- b) Requiring preservation of specified reasonable legal notices or author attributions in that material or in the Appropriate Legal Notices displayed by works containing it; or
- c) Prohibiting misrepresentation of the origin of that material, or requiring that modified versions of such material be marked in reasonable ways as different from the original version; or
- d) Limiting the use for publicity purposes of names of licensors or authors of the material; or
- e) Declining to grant rights under trademark law for use of some trade names, trademarks, or service marks; or
- f) Requiring indemnification of licensors and authors of that material by anyone who conveys the material (or modified versions of it) with contractual assumptions of liability to the recipient, for any liability that these contractual assumptions directly impose on those licensors and authors.

All other non-permissive additional terms are considered "further restrictions" within the meaning of section 10. If the Program as you received it, or any part of it, contains a notice stating that it is governed by this License along with a term that is a further restriction, you may remove that term. If a license document contains a further restriction but permits relicensing or conveying under this License, you may add to a covered work material governed by the terms of that license document, provided that the further restriction does not survive such relicensing or conveying.

If you add terms to a covered work in accord with this section, you must place, in the relevant source files, a statement of the additional terms that apply to those files, or a notice indicating where to find the applicable terms.

Additional terms, permissive or non-permissive, may be stated in the form of a separately written license, or stated as exceptions; the above requirements apply either way.

## 8. TERMINATION

You may not propagate or modify a covered work except as expressly provided under this License. Any attempt otherwise to propagate or modify it is void, and will automatically terminate your rights under this License (including any patent licenses granted under the third paragraph of section 11).

However, if you cease all violation of this License, then your license from a particular copyright holder is reinstated (a) provisionally, unless and until the copyright holder explicitly and finally terminates your license, and (b) permanently, if the copyright holder fails to notify you of the violation by some reasonable means prior to 60 days after the cessation.

Moreover, your license from a particular copyright holder is reinstated permanently if the copyright holder notifies you of the violation by some reasonable means, this is the first time you have received notice of violation of this License (for any work) from that copyright holder, and you cure the violation prior to 30 days after your receipt of the notice.

Termination of your rights under this section does not terminate the licenses of parties who have received copies or rights from you under this License. If your rights have been terminated and not permanently reinstated, you do not qualify to receive new licenses for the same material under section 10.

#### 9. ACCEPTANCE NOT REQUIRED FOR HAVING COPIES

You are not required to accept this License in order to receive or run a copy of the Program. Ancillary propagation of a covered work occurring solely as a consequence of using peer-to-peer transmission to receive a copy likewise does not require acceptance. However, nothing other than this License grants you permission to propagate or modify any covered work. These actions infringe copyright if you do not accept this License. Therefore, by modifying or propagating a covered work, you indicate your acceptance of this License to do so.

#### 10. AUTOMATIC LICENSING OF DOWNSTREAM RECIPIENTS

Each time you convey a covered work, the recipient automatically receives a license from the original licensors, to run, modify and propagate that work, subject to this License. You are not responsible for enforcing compliance by third parties with this License.

An "entity transaction" is a transaction transferring control of an organization, or substantially all assets of one, or subdividing an organization, or merging organizations. If propagation of a covered work results from an entity transaction, each party to that transaction who receives a copy of the work also receives whatever licenses to the work the party's predecessor in interest had or could give under the previous paragraph, plus a right to possession of the Corresponding Source of the work from the predecessor in interest, if the predecessor has it or can get it with reasonable efforts.

You may not impose any further restrictions on the exercise of the rights granted or affirmed under this License. For example, you may not impose a license fee, royalty, or other charge for exercise of rights granted under this License, and you may not initiate litigation (including a cross-claim or counterclaim in a lawsuit) alleging that any patent claim is infringed by making, using, selling, offering for sale, or importing the Program or any portion of it.

#### 11. PATENTS

A "contributor" is a copyright holder who authorizes use under this License of the Program or a work on which the Program is based. The work thus licensed is called the contributor's "contributor version".

A contributor's "essential patent claims" are all patent claims owned or controlled by the contributor, whether already acquired or hereafter acquired, that would be infringed by some manner, permitted by this License, of making, using, or selling its contributor version, but do not include claims that would be infringed only as a consequence of further modification of the contributor version. For purposes of this definition, "control" includes the right to grant patent sublicenses in a manner consistent with the requirements of this License.

Each contributor grants you a non-exclusive, worldwide, royalty-free patent license under the contributor's essential patent claims, to make, use, sell, offer for sale, import and otherwise run, modify and propagate the contents of its contributor version.

In the following three paragraphs, a "patent license" is any express agreement or commitment, however denominated, not to enforce a patent (such as an express permission to practice a patent or covenant not to sue for patent infringement). To "grant" such a patent license to a party means to make such an agreement or commitment not to enforce a patent against the party.

If you convey a covered work, knowingly relying on a patent license, and the Corresponding Source of the work is not available for anyone to copy, free of charge and under the terms of this License, through a publicly available network server or other readily accessible means, then you must either (1) cause the Corresponding Source to be so available, or (2) arrange to deprive yourself of the benefit of the patent license for this particular work, or (3) arrange, in a manner consistent with the requirements of this License, to extend the patent license to downstream recipients. "Knowingly relying" means you have actual knowledge that, but for the patent license, your conveying the covered work in a country, or your recipient's use of the covered work in a country, would infringe one or more identifiable patents in that country that you have reason to believe are valid.

If, pursuant to or in connection with a single transaction or arrangement, you convey, or propagate by procuring conveyance of, a covered work, and grant a patent license to some of the parties receiving the covered work authorizing them to use, propagate, modify or convey a specific copy of the covered work, then the patent license you grant is automatically extended to all recipients of the covered work and works based on it.

A patent license is "discriminatory" if it does not include within the scope of its coverage, prohibits the exercise of, or is conditioned on the non-exercise of one or more of the rights that are specifically granted under this License. You may not convey a covered work if you are a party to an arrangement with a third party that is in the business of distributing software, under which you make payment to the third party based on the extent of your activity of conveying the work, and under which the third party grants, to any of the parties who would receive the covered work from you, a discriminatory patent license (a) in connection with copies of the covered work conveyed by you (or copies made from those copies), or (b) primarily for and in connection with specific products or compilations that contain the covered work, unless you entered into that arrangement, or that patent license was granted, prior to 28 March 2007.

Nothing in this License shall be construed as excluding or limiting any implied license or other defenses to infringement that may otherwise be available to you under applicable patent law.

## 12. NO SURRENDER OF OTHERS' FREEDOM

If conditions are imposed on you (whether by court order, agreement or otherwise) that contradict the conditions of this License, they do not excuse you from the conditions of this License. If you cannot convey a covered work so as to satisfy simultaneously your obligations under this License and any other pertinent obligations, then as a consequence you may not convey it at all. For example, if you agree to terms that obligate you to collect a royalty for further conveying from those to whom you convey

the Program, the only way you could satisfy both those terms and this License would be to refrain entirely from conveying the Program.

### 13. USE WITH THE GNU AFFERO GENERAL PUBLIC LICENSE

Notwithstanding any other provision of this License, you have permission to link or combine any covered work with a work licensed under version 3 of the GNU Affero General Public License into a single combined work, and to convey the resulting work. The terms of this License will continue to apply to the part which is the covered work, but the special requirements of the GNU Affero General Public License, section 13, concerning interaction through a network will apply to the combination as such.

### 14. REVISED VERSIONS OF THIS LICENSE

The Free Software Foundation may publish revised and/or new versions of the GNU General Public License from time to time. Such new versions will be similar in spirit to the present version, but may differ in detail to address new problems or concerns.

Each version is given a distinguishing version number. If the Program specifies that a certain numbered version of the GNU General Public License "or any later version" applies to it, you have the option of following the terms and conditions either of that numbered version or of any later version published by the Free Software Foundation. If the Program does not specify a version number of the GNU General Public License, you may choose any version ever published by the Free Software Foundation.

If the Program specifies that a proxy can decide which future versions of the GNU General Public License can be used, that proxy's public statement of acceptance of a version permanently authorizes you to choose that version for the Program.

Later license versions may give you additional or different permissions. However, no additional obligations are imposed on any author or copyright holder as a result of your choosing to follow a later version.

### 15. DISCLAIMER OF WARRANTY

THERE IS NO WARRANTY FOR THE PROGRAM, TO THE EXTENT PERMITTED BY APPLICABLE LAW. EXCEPT WHEN OTHERWISE STATED IN WRITING THE COPYRIGHT HOLDERS AND/OR OTHER PARTIES PROVIDE THE PROGRAM "AS IS" WITHOUT WARRANTY OF ANY KIND, EITHER EXPRESSED OR IMPLIED, INCLUDING, BUT NOT LIMITED TO, THE IMPLIED WARRANTIES OF MERCHANTABILITY AND FITNESS FOR A PARTICULAR PURPOSE. THE ENTIRE RISK AS TO THE QUALITY AND PERFORMANCE OF THE PROGRAM IS WITH YOU. SHOULD THE PROGRAM PROVE DEFECTIVE, YOU ASSUME THE COST OF ALL NECESSARY SERVICING, REPAIR OR CORRECTION.

### 16. LIMITATION OF LIABILITY.

IN NO EVENT UNLESS REQUIRED BY APPLICABLE LAW OR AGREED TO IN WRITING WILL ANY COPYRIGHT HOLDER, OR ANY OTHER PARTY WHO MODIFIES AND/OR CONVEYS THE PROGRAM AS PERMITTED ABOVE, BE LIABLE TO YOU FOR DAMAGES, INCLUDING ANY GENERAL, SPECIAL, IN-



CIDENTAL OR CONSEQUENTIAL DAMAGES ARISING OUT OF THE USE OR INABILITY TO USE THE PROGRAM (INCLUDING BUT NOT LIMITED TO LOSS OF DATA OR DATA BEING RENDERED INACCURATE OR LOSSES SUSTAINED BY YOU OR THIRD PARTIES OR A FAILURE OF THE PROGRAM TO OPERATE WITH ANY OTHER PROGRAMS), EVEN IF SUCH HOLDER OR OTHER PARTY HAS BEEN ADVISED OF THE POSSIBILITY OF SUCH DAMAGES.

#### 17. INTERPRETATION OF SECTIONS 15 AND 16

If the disclaimer of warranty and limitation of liability provided above cannot be given local legal effect according to their terms, reviewing courts shall apply local law that most closely approximates an absolute waiver of all civil liability in connection with the Program, unless a warranty or assumption of liability accompanies a copy of the Program in return for a fee.

## How to Apply These Terms to your New Programs

If you develop a new program, and you want it to be of the greatest possible use to the public, the best way to achieve this is to make it free software which everyone can redistribute and change under these terms.

To do so, attach the following notices to the program. It is safest to attach them to the start of each source file to most effectively state the exclusion of warranty; and each file should have at least the "copyright" line and a pointer to where the full notice is found.

```
<one line to give the program's name and a brief idea of what it does.> Copyright
(C) <year> <name of author>
```

This program is free software: you can redistribute it and/or modify it under the terms of the GNU General Public License as published by the Free Software Foundation, either version 3 of the License, or (at your option) any later version.

This program is distributed in the hope that it will be useful, but WITHOUT ANY WARRANTY; without even the implied warranty of MERCHANTABILITY or FITNESS FOR A PARTICULAR PURPOSE. See the GNU General Public License for more details.

You should have received a copy of the GNU General Public License along with this program. If not, see <http://www.gnu.org/licenses/>.

Also add information on how to contact you by electronic and paper mail.

If the program does terminal interaction, make it output a short notice like this when it starts in an interactive mode:

```
<program> Copyright (C) <year> <name of author> This program comes with AB-
SOLUTELY NO WARRANTY; for details type 'show w'. This is free software, and you
are welcome to redistribute it under certain conditions; type 'show c' for details.
```

The hypothetical commands 'show w' and 'show c' should show the appropriate parts of the General Public License. Of course, your program's commands might be different; for a GUI interface, you would use an "about box".

You should also get your employer (if you work as a programmer) or school, if any, to sign a "copyright disclaimer" for the program, if necessary. For more information on this, and how to apply and follow the GNU GPL, see <http://www.gnu.org/licenses/>.

The GNU General Public License does not permit incorporating your program into proprietary programs. If your program is a subroutine library, you may consider it more useful to permit linking proprietary applications with the library. If this is what you want to do, use the GNU Lesser General Public License instead of this License. But first, please read <<http://www.gnu.org/philosophy/why-not-lgpl.html>>.

## A.5 GNU FREE DOCUMENTATION LICENSE

Version 1.3, 3 November 2008

Copyright © 2000, 2001, 2002, 2007, 2008 Free Software Foundation, Inc.

<http://fsf.org/>

Everyone is permitted to copy and distribute verbatim copies of this license document, but changing it is not allowed.

### 0. PREAMBLE

The purpose of this License is to make a manual, textbook, or other functional and useful document *free* in the sense of freedom: to assure everyone the effective freedom to copy and redistribute it, with or without modifying it, either commercially or non-commercially. Secondly, this License preserves for the author and publisher a way to get credit for their work, while not being considered responsible for modifications made by others.

This License is a kind of “copyleft”, which means that derivative works of the document must themselves be free in the same sense. It complements the GNU General Public License, which is a copyleft license designed for free software.

We have designed this License in order to use it for manuals for free software, because free software needs free documentation: a free program should come with manuals providing the same freedoms that the software does. But this License is not limited to software manuals; it can be used for any textual work, regardless of subject matter or whether it is published as a printed book. We recommend this License principally for works whose purpose is instruction or reference.

### 1. APPLICABILITY AND DEFINITIONS

This License applies to any manual or other work, in any medium, that contains a notice placed by the copyright holder saying it can be distributed under the terms of this License. Such a notice grants a world-wide, royalty-free license, unlimited in duration, to use that work under the conditions stated herein. The “Document”, below, refers to any such manual or work. Any member of the public is a licensee, and is addressed as “you”. You accept the license if you copy, modify or distribute the work in a way requiring permission under copyright law.

A “Modified Version” of the Document means any work containing the Document or a portion of it, either copied verbatim, or with modifications and/or translated into another language.

A “Secondary Section” is a named appendix or a front-matter section of the Document that deals exclusively with the relationship of the publishers or authors of the Document to the Document’s overall subject (or to related matters) and contains nothing that could fall directly within that overall subject. (Thus, if the Document is in part a textbook of mathematics, a Secondary Section may not explain any mathematics.) The

relationship could be a matter of historical connection with the subject or with related matters, or of legal, commercial, philosophical, ethical or political position regarding them.

The “Invariant Sections” are certain Secondary Sections whose titles are designated, as being those of Invariant Sections, in the notice that says that the Document is released under this License. If a section does not fit the above definition of Secondary then it is not allowed to be designated as Invariant. The Document may contain zero Invariant Sections. If the Document does not identify any Invariant Sections then there are none.

The “Cover Texts” are certain short passages of text that are listed, as Front-Cover Texts or Back-Cover Texts, in the notice that says that the Document is released under this License. A Front-Cover Text may be at most 5 words, and a Back-Cover Text may be at most 25 words.

A “Transparent” copy of the Document means a machine-readable copy, represented in a format whose specification is available to the general public, that is suitable for revising the document straightforwardly with generic text editors or (for images composed of pixels) generic paint programs or (for drawings) some widely available drawing editor, and that is suitable for input to text formatters or for automatic translation to a variety of formats suitable for input to text formatters. A copy made in an otherwise Transparent file format whose markup, or absence of markup, has been arranged to thwart or discourage subsequent modification by readers is not Transparent. An image format is not Transparent if used for any substantial amount of text. A copy that is not “Transparent” is called “Opaque”.

Examples of suitable formats for Transparent copies include plain ASCII without markup, Texinfo input format, LaTeX input format, SGML or XML using a publicly available DTD, and standard-conforming simple HTML, PostScript or PDF designed for human modification. Examples of transparent image formats include PNG, XCF and JPG. Opaque formats include proprietary formats that can be read and edited only by proprietary word processors, SGML or XML for which the DTD and/or processing tools are not generally available, and the machine-generated HTML, PostScript or PDF produced by some word processors for output purposes only.

The “Title Page” means, for a printed book, the title page itself, plus such following pages as are needed to hold, legibly, the material this License requires to appear in the title page. For works in formats which do not have any title page as such, “Title Page” means the text near the most prominent appearance of the work’s title, preceding the beginning of the body of the text.

The “publisher” means any person or entity that distributes copies of the Document to the public.

A section “Entitled XYZ” means a named subunit of the Document whose title either is precisely XYZ or contains XYZ in parentheses following text that translates XYZ in another language. (Here XYZ stands for a specific section name mentioned below, such as “Acknowledgements”, “Dedications”, “Endorsements”, or “History”.) To “Preserve the Title” of such a section when you modify the Document means that it remains a section “Entitled XYZ” according to this definition.

The Document may include Warranty Disclaimers next to the notice which states that this License applies to the Document. These Warranty Disclaimers are considered to

be included by reference in this License, but only as regards disclaiming warranties: any other implication that these Warranty Disclaimers may have is void and has no effect on the meaning of this License.

## 2. VERBATIM COPYING

You may copy and distribute the Document in any medium, either commercially or noncommercially, provided that this License, the copyright notices, and the license notice saying this License applies to the Document are reproduced in all copies, and that you add no other conditions whatsoever to those of this License. You may not use technical measures to obstruct or control the reading or further copying of the copies you make or distribute. However, you may accept compensation in exchange for copies. If you distribute a large enough number of copies you must also follow the conditions in section 3.

You may also lend copies, under the same conditions stated above, and you may publicly display copies.

## 3. COPYING IN QUANTITY

If you publish printed copies (or copies in media that commonly have printed covers) of the Document, numbering more than 100, and the Document's license notice requires Cover Texts, you must enclose the copies in covers that carry, clearly and legibly, all these Cover Texts: Front-Cover Texts on the front cover, and Back-Cover Texts on the back cover. Both covers must also clearly and legibly identify you as the publisher of these copies. The front cover must present the full title with all words of the title equally prominent and visible. You may add other material on the covers in addition. Copying with changes limited to the covers, as long as they preserve the title of the Document and satisfy these conditions, can be treated as verbatim copying in other respects.

If the required texts for either cover are too voluminous to fit legibly, you should put the first ones listed (as many as fit reasonably) on the actual cover, and continue the rest onto adjacent pages.

If you publish or distribute Opaque copies of the Document numbering more than 100, you must either include a machine-readable Transparent copy along with each Opaque copy, or state in or with each Opaque copy a computer-network location from which the general network-using public has access to download using public-standard network protocols a complete Transparent copy of the Document, free of added material. If you use the latter option, you must take reasonably prudent steps, when you begin distribution of Opaque copies in quantity, to ensure that this Transparent copy will remain thus accessible at the stated location until at least one year after the last time you distribute an Opaque copy (directly or through your agents or retailers) of that edition to the public.

It is requested, but not required, that you contact the authors of the Document well before redistributing any large number of copies, to give them a chance to provide you with an updated version of the Document.

## 4. MODIFICATIONS

You may copy and distribute a Modified Version of the Document under the conditions of sections 2 and 3 above, provided that you release the Modified Version under precisely this License, with the Modified Version filling the role of the Document, thus licensing

distribution and modification of the Modified Version to whoever possesses a copy of it. In addition, you must do these things in the Modified Version:

- A. Use in the Title Page (and on the covers, if any) a title distinct from that of the Document, and from those of previous versions (which should, if there were any, be listed in the History section of the Document). You may use the same title as a previous version if the original publisher of that version gives permission.
- B. List on the Title Page, as authors, one or more persons or entities responsible for authorship of the modifications in the Modified Version, together with at least five of the principal authors of the Document (all of its principal authors, if it has fewer than five), unless they release you from this requirement.
- C. State on the Title page the name of the publisher of the Modified Version, as the publisher.
- D. Preserve all the copyright notices of the Document.
- E. Add an appropriate copyright notice for your modifications adjacent to the other copyright notices.
- F. Include, immediately after the copyright notices, a license notice giving the public permission to use the Modified Version under the terms of this License, in the form shown in the Addendum below.
- G. Preserve in that license notice the full lists of Invariant Sections and required Cover Texts given in the Document's license notice.
- H. Include an unaltered copy of this License.
- I. Preserve the section Entitled "History", Preserve its Title, and add to it an item stating at least the title, year, new authors, and publisher of the Modified Version as given on the Title Page. If there is no section Entitled "History" in the Document, create one stating the title, year, authors, and publisher of the Document as given on its Title Page, then add an item describing the Modified Version as stated in the previous sentence.
- J. Preserve the network location, if any, given in the Document for public access to a Transparent copy of the Document, and likewise the network locations given in the Document for previous versions it was based on. These may be placed in the "History" section. You may omit a network location for a work that was published at least four years before the Document itself, or if the original publisher of the version it refers to gives permission.
- K. For any section Entitled "Acknowledgements" or "Dedications", Preserve the Title of the section, and preserve in the section all the substance and tone of each of the contributor acknowledgements and/or dedications given therein.
- L. Preserve all the Invariant Sections of the Document, unaltered in their text and in their titles. Section numbers or the equivalent are not considered part of the section titles.
- M. Delete any section Entitled "Endorsements". Such a section may not be included in the Modified Version.
- N. Do not retitle any existing section to be Entitled "Endorsements" or to conflict in title with any Invariant Section.
- O. Preserve any Warranty Disclaimers.

If the Modified Version includes new front-matter sections or appendices that qualify as Secondary Sections and contain no material copied from the Document, you may at your option designate some or all of these sections as invariant. To do this, add their titles to the list of Invariant Sections in the Modified Version's license notice. These titles must be distinct from any other section titles.

You may add a section Entitled "Endorsements", provided it contains nothing but endorsements of your Modified Version by various parties—for example, statements of peer review or that the text has been approved by an organization as the authoritative definition of a standard.

You may add a passage of up to five words as a Front-Cover Text, and a passage of up to 25 words as a Back-Cover Text, to the end of the list of Cover Texts in the Modified Version. Only one passage of Front-Cover Text and one of Back-Cover Text may be added by (or through arrangements made by) any one entity. If the Document already includes a cover text for the same cover, previously added by you or by arrangement made by the same entity you are acting on behalf of, you may not add another; but you may replace the old one, on explicit permission from the previous publisher that added the old one.

The author(s) and publisher(s) of the Document do not by this License give permission to use their names for publicity for or to assert or imply endorsement of any Modified Version.

## 5. COMBINING DOCUMENTS

You may combine the Document with other documents released under this License, under the terms defined in section 4 above for modified versions, provided that you include in the combination all of the Invariant Sections of all of the original documents, unmodified, and list them all as Invariant Sections of your combined work in its license notice, and that you preserve all their Warranty Disclaimers.

The combined work need only contain one copy of this License, and multiple identical Invariant Sections may be replaced with a single copy. If there are multiple Invariant Sections with the same name but different contents, make the title of each such section unique by adding at the end of it, in parentheses, the name of the original author or publisher of that section if known, or else a unique number. Make the same adjustment to the section titles in the list of Invariant Sections in the license notice of the combined work.

In the combination, you must combine any sections Entitled "History" in the various original documents, forming one section Entitled "History"; likewise combine any sections Entitled "Acknowledgements", and any sections Entitled "Dedications". You must delete all sections Entitled "Endorsements."

## 6. COLLECTIONS OF DOCUMENTS

You may make a collection consisting of the Document and other documents released under this License, and replace the individual copies of this License in the various documents with a single copy that is included in the collection, provided that you follow the rules of this License for verbatim copying of each of the documents in all other respects.

You may extract a single document from such a collection, and distribute it individually under this License, provided you insert a copy of this License into the extracted

document, and follow this License in all other respects regarding verbatim copying of that document.

## 7. AGGREGATION WITH INDEPENDENT WORKS

A compilation of the Document or its derivatives with other separate and independent documents or works, in or on a volume of a storage or distribution medium, is called an “aggregate” if the copyright resulting from the compilation is not used to limit the legal rights of the compilation’s users beyond what the individual works permit. When the Document is included in an aggregate, this License does not apply to the other works in the aggregate which are not themselves derivative works of the Document.

If the Cover Text requirement of section 3 is applicable to these copies of the Document, then if the Document is less than one half of the entire aggregate, the Document’s Cover Texts may be placed on covers that bracket the Document within the aggregate, or the electronic equivalent of covers if the Document is in electronic form. Otherwise they must appear on printed covers that bracket the whole aggregate.

## 8. TRANSLATION

Translation is considered a kind of modification, so you may distribute translations of the Document under the terms of section 4. Replacing Invariant Sections with translations requires special permission from their copyright holders, but you may include translations of some or all Invariant Sections in addition to the original versions of these Invariant Sections. You may include a translation of this License, and all the license notices in the Document, and any Warranty Disclaimers, provided that you also include the original English version of this License and the original versions of those notices and disclaimers. In case of a disagreement between the translation and the original version of this License or a notice or disclaimer, the original version will prevail.

If a section in the Document is Entitled “Acknowledgements”, “Dedications”, or “History”, the requirement (section 4) to Preserve its Title (section 1) will typically require changing the actual title.

## 9. TERMINATION

You may not copy, modify, sublicense, or distribute the Document except as expressly provided under this License. Any attempt otherwise to copy, modify, sublicense, or distribute it is void, and will automatically terminate your rights under this License.

However, if you cease all violation of this License, then your license from a particular copyright holder is reinstated (a) provisionally, unless and until the copyright holder explicitly and finally terminates your license, and (b) permanently, if the copyright holder fails to notify you of the violation by some reasonable means prior to 60 days after the cessation.

Moreover, your license from a particular copyright holder is reinstated permanently if the copyright holder notifies you of the violation by some reasonable means, this is the first time you have received notice of violation of this License (for any work) from that copyright holder, and you cure the violation prior to 30 days after your receipt of the notice.

Termination of your rights under this section does not terminate the licenses of parties who have received copies or rights from you under this License. If your rights have

been terminated and not permanently reinstated, receipt of a copy of some or all of the same material does not give you any rights to use it.

#### 10. FUTURE REVISIONS OF THIS LICENSE

The Free Software Foundation may publish new, revised versions of the GNU Free Documentation License from time to time. Such new versions will be similar in spirit to the present version, but may differ in detail to address new problems or concerns. See <http://www.gnu.org/copyleft/>.

Each version of the License is given a distinguishing version number. If the Document specifies that a particular numbered version of this License “or any later version” applies to it, you have the option of following the terms and conditions either of that specified version or of any later version that has been published (not as a draft) by the Free Software Foundation. If the Document does not specify a version number of this License, you may choose any version ever published (not as a draft) by the Free Software Foundation. If the Document specifies that a proxy can decide which future versions of this License can be used, that proxy’s public statement of acceptance of a version permanently authorizes you to choose that version for the Document.

#### 11. RELICENSING

“Massive Multiauthor Collaboration Site” (or “MMC Site”) means any World Wide Web server that publishes copyrightable works and also provides prominent facilities for anybody to edit those works. A public wiki that anybody can edit is an example of such a server. A “Massive Multiauthor Collaboration” (or “MMC”) contained in the site means any set of copyrightable works thus published on the MMC site.

“CC-BY-SA” means the Creative Commons Attribution-Share Alike 3.0 license published by Creative Commons Corporation, a not-for-profit corporation with a principal place of business in San Francisco, California, as well as future copyleft versions of that license published by that same organization.

“Incorporate” means to publish or republish a Document, in whole or in part, as part of another Document.

An MMC is “eligible for relicensing” if it is licensed under this License, and if all works that were first published under this License somewhere other than this MMC, and subsequently incorporated in whole or in part into the MMC, (1) had no cover texts or invariant sections, and (2) were thus incorporated prior to November 1, 2008.

The operator of an MMC Site may republish an MMC contained in the site under CC-BY-SA on the same site at any time before August 1, 2009, provided the MMC is eligible for relicensing.



## ADDENDUM: How to use this License for your documents

To use this License in a document you have written, include a copy of the License in the document and put the following copyright and license notices just after the title page:

```
Copyright (C) year your name.
Permission is granted to copy, distribute and/or modify this document
under the terms of the GNU Free Documentation License, Version 1.3
or any later version published by the Free Software Foundation;
with no Invariant Sections, no Front-Cover Texts, and no Back-Cover
Texts. A copy of the license is included in the section entitled ‘‘GNU
Free Documentation License’’.
```

If you have Invariant Sections, Front-Cover Texts and Back-Cover Texts, replace the “with...Texts.” line with this:

```
with the Invariant Sections being list their titles, with
the Front-Cover Texts being list, and with the Back-Cover Texts
being list.
```

If you have Invariant Sections without Cover Texts, or some other combination of the three, merge those two alternatives to suit the situation.

If your document contains nontrivial examples of program code, we recommend releasing these examples in parallel under your choice of free software license, such as the GNU General Public License, to permit their use in free software.

### A.6 The Go Text Protocol License

In order to facilitate the use of the Go Text Protocol, the two files ‘gtp.c’ and ‘gtp.h’ are licensed under the following terms.

Copyright 2001 by the Free Software Foundation.

Permission is hereby granted, free of charge, to any person obtaining a copy of this file ‘gtp.x’, to deal in the Software without restriction, including without limitation the rights to use, copy, modify, merge, publish, distribute, and/or sell copies of the Software, and to permit persons to whom the Software is furnished to do so, provided that the above copyright notice(s) and this permission notice appear in all copies of the Software and that both the above copyright notice(s) and this permission notice appear in supporting documentation.

THE SOFTWARE IS PROVIDED "AS IS", WITHOUT WARRANTY OF ANY KIND, EXPRESS OR IMPLIED, INCLUDING BUT NOT LIMITED TO THE WARRANTIES OF MERCHANTABILITY, FITNESS FOR A PARTICULAR PURPOSE AND NONINFRINGEMENT OF THIRD PARTY RIGHTS. IN NO EVENT SHALL THE COPYRIGHT HOLDER OR HOLDERS INCLUDED IN THIS NOTICE BE LIABLE FOR ANY CLAIM, OR ANY SPECIAL INDIRECT OR CONSEQUENTIAL DAMAGES, OR ANY DAMAGES WHATSOEVER RESULTING FROM LOSS OF USE, DATA OR PROFITS, WHETHER IN AN ACTION OF CONTRACT, NEGLIGENCE OR OTHER TORTIOUS ACTION, ARISING OUT OF OR IN CONNECTION WITH THE USE OR PERFORMANCE OF THIS SOFTWARE.

Except as contained in this notice, the name of a copyright holder shall not be used in advertising or otherwise to promote the sale, use or other dealings in this Software without prior written authorization of the copyright holder.

# Concept Index

## A

|                                    |     |
|------------------------------------|-----|
| aa_confirm_safety                  | 192 |
| accurate_approxlib                 | 187 |
| accuratelib                        | 187 |
| adjacent dragons                   | 56  |
| advance_random_seed                | 200 |
| all_legal                          | 188 |
| amalgamation of worms into dragons | 51  |
| analyze_eyegraph                   | 196 |
| analyze_semeai                     | 190 |
| analyze_semeai_after_move          | 190 |
| API                                | 161 |
| area                               | 129 |
| ascii description of shapes        | 77  |
| ascii interface                    | 13  |
| ascii mode                         | 19  |
| attack                             | 189 |
| attack shapes database             | 77  |
| attack_either                      | 189 |
| autohelper actions                 | 83  |
| Autohelpers                        | 82  |
| automaton                          | 103 |

## B

|             |     |
|-------------|-----|
| black       | 186 |
| block_off   | 191 |
| board_state | 163 |
| boardsize   | 185 |
| break_in    | 191 |

## C

|                            |        |
|----------------------------|--------|
| cache                      | 16     |
| cache-size                 | 16     |
| captures                   | 188    |
| CGoban                     | 11     |
| clear_board                | 185    |
| clear_cache                | 189    |
| color                      | 187    |
| color (dragon)             | 56     |
| colored display            | 38, 59 |
| combination_attack         | 192    |
| combination_defend         | 192    |
| command line options       | 14     |
| connect                    | 191    |
| connection shapes database | 77, 90 |
| connections                | 52     |
| connections database       | 90     |
| corner matcher             | 100    |
| countlib                   | 187    |
| cputime                    | 196    |
| cutting stone              | 49     |
| cutting stone, potential   | 50     |

## D

|                                 |     |
|---------------------------------|-----|
| data structures                 | 162 |
| debugging on a graphical board  | 38  |
| debugging options               | 20  |
| Debugging the reading code      | 122 |
| decide-dragon                   | 37  |
| decide-string                   | 36  |
| decrease_depths                 | 189 |
| defence shapes database         | 77  |
| defend                          | 189 |
| defend_both                     | 190 |
| depth                           | 17  |
| Depth of reading                | 111 |
| description of shapes           | 77  |
| dfa                             | 103 |
| dfa.c                           | 103 |
| dfa.h                           | 103 |
| disconnect                      | 191 |
| distance from liberty to dragon | 49  |
| does_attack                     | 189 |
| does_defend                     | 189 |
| does_surround                   | 200 |
| dragon                          | 47  |
| dragon escape_route             | 57  |
| dragon genus                    | 57  |
| dragon lunch                    | 58  |
| dragon number                   | 56  |
| dragon origin                   | 56  |
| dragon safety                   | 57  |
| dragon size                     | 56  |
| dragon status                   | 56  |
| dragon weakness                 | 57  |
| dragon_data                     | 198 |
| dragon_status                   | 191 |
| dragon_stones                   | 198 |
| dragons                         | 54  |
| draw_search_area                | 201 |
| dump_stack                      | 196 |

## E

|                          |     |
|--------------------------|-----|
| echo                     | 199 |
| echo_err                 | 199 |
| editing pattern database | 102 |
| editing patterns         | 102 |
| effective size           | 56  |
| effective size (worm)    | 48  |
| eliminate the randomness | 95  |
| emacs mode               | 13  |
| escape_route             | 57  |
| estimate_score           | 194 |
| eval_eye                 | 191 |
| experimental_score       | 194 |
| eye shapes database      | 77  |

eye space display ..... 39  
 eye\_data ..... 198

**F**

false eye ..... 53  
 fast pattern matching ..... 103  
 final\_score ..... 194  
 final\_status ..... 194  
 final\_status\_list ..... 194  
 findlib ..... 187  
 finish\_sgfttrace ..... 199  
 finite state automaton ..... 103  
 fixed\_handicap ..... 186  
 FIXME ..... 35  
 followup\_influence ..... 197  
 format of the pattern database ..... 77  
 formatted printing ..... 172

**G**

GDB ..... 38, 123  
 generation of helper functions ..... 82  
 genmove ..... 192  
 genmove\_black ..... 192  
 genmove\_white ..... 192  
 genus ..... 57  
 genus (worm) ..... 50  
 get\_connection\_node\_counter ..... 195  
 get\_handicap ..... 187  
 get\_komi ..... 186  
 get\_life\_node\_counter ..... 195  
 get\_owl\_node\_counter ..... 195  
 get\_random\_seed ..... 200  
 get\_reading\_node\_counter ..... 195  
 get\_trymove\_counter ..... 195  
 gg-undo ..... 193  
 gg\_genmove ..... 193  
 GMP ..... 13  
 GNU Go's GDB commands ..... 124  
 go position ..... 113  
 grid optimization ..... 96  
 GTP ..... 13, 38  
 GTP command reference ..... 184

**H**

half eye ..... 53  
 half\_eye\_data ..... 198  
 Hash node ..... 114  
 Hashing of positions ..... 113  
 help ..... 199  
 helper functions in pattern matching ..... 81  
 how GNU Go learns new joseki ..... 98  
 How to debug the reading code ..... 122

**I**

implementation of pattern matching ..... 95, 100  
 increase\_depths ..... 189  
 inessential string ..... 50  
 initial\_influence ..... 196  
 installation ..... 5  
 invariant\_hash ..... 188  
 invariant\_hash\_for\_moves ..... 188  
 invincible worm ..... 50  
 invoking GNU Go ..... 14  
 is\_legal ..... 188  
 is\_surrounded ..... 200

**J**

jago ..... 12  
 joseki ..... 98, 100

**K**

kgs-genmove\_cleanup ..... 193  
 known\_command ..... 199  
 komi ..... 186

**L**

ladder\_attack ..... 189  
 last\_move ..... 188  
 level ..... 17, 193  
 level of play ..... 14  
 liberties (worm) ..... 48  
 liberties, higher order (worm) ..... 48  
 licence, documentation (GFDL) ..... 218  
 licence, program (GPL) ..... 207  
 limit\_search ..... 200  
 list\_stones ..... 187  
 loadsgf ..... 187  
 lunch ..... 58  
 lunch (worm) ..... 49

**M**

matchpat.c ..... 103  
 Monte Carlo Go ..... 146  
 move generation ..... 25  
 move generators ..... 25  
 move reasons ..... 25, 40  
 move\_history ..... 188  
 move\_influence ..... 197  
 move\_probabilities ..... 197  
 move\_uncertainty ..... 197  
 moyo ..... 129

**N**

name ..... 185  
 neighbor dragons ..... 56

**O**

|                          |     |
|--------------------------|-----|
| orientation              | 185 |
| origin (worm)            | 48  |
| output file              | 36  |
| owl_attack               | 189 |
| owl_attack_certain       | 59  |
| owl_attack_code          | 59  |
| owl_attack_point         | 58  |
| owl_connection_defends   | 190 |
| owl_defend               | 190 |
| owl_defense_certain      | 59  |
| owl_defense_code         | 59  |
| owl_defense_point        | 59  |
| owl_does_attack          | 190 |
| owl_does_defend          | 190 |
| owl_second_attack_point  | 59  |
| owl_second_defense_point | 59  |
| owl_substantial          | 190 |
| owl_threaten_attack      | 190 |
| owl_threaten_defense     | 190 |

**P**

|                               |         |
|-------------------------------|---------|
| pattern attributes            | 78      |
| pattern database              | 77, 103 |
| pattern matching              | 77, 103 |
| pattern matching optimization | 96      |
| pattern overview              | 77      |
| pattern.c                     | 77      |
| pattern.h                     | 77      |
| persistent cache              | 116     |
| place_free_handicap           | 186     |
| play                          | 186     |
| playwhite                     | 186     |
| popgo                         | 188     |
| position                      | 113     |
| position struct               | 162     |
| potential cutting stone       | 50      |
| printsgf                      | 199     |
| product                       | 103     |
| protocol_version              | 185     |

**Q**

|                   |     |
|-------------------|-----|
| qGo               | 12  |
| quarry            | 12  |
| query_boardsize   | 185 |
| query_orientation | 185 |
| quit              | 185 |

**R**

|                              |     |
|------------------------------|-----|
| Read result                  | 114 |
| Reading code                 | 111 |
| Reading code debugging tools | 122 |
| reading DEPTH                | 111 |
| Reading optimisation         | 113 |
| Reading process              | 111 |

|                               |          |
|-------------------------------|----------|
| reading return codes          | 111      |
| reading shadow                | 117      |
| reading.c                     | 111, 112 |
| reading.h                     | 111      |
| reg_genmove                   | 192      |
| report_uncertainty            | 200      |
| reset_connection_node_counter | 195      |
| reset_life_node_counter       | 194      |
| reset_owl_node_counter        | 195      |
| reset_reading_node_counter    | 195      |
| reset_search_mask             | 200      |
| reset_trymove_counter         | 195      |
| restricted_genmove            | 193      |
| return codes                  | 111      |

**S**

|                                        |     |
|----------------------------------------|-----|
| same_dragon                            | 191 |
| scoring                                | 38  |
| semeai                                 | 58  |
| semeai_attack_certain                  | 58  |
| semeai_attack_point                    | 58  |
| semeai_defense_certain                 | 58  |
| semeai_defense_point                   | 58  |
| set_free_handicap                      | 187 |
| set_random_seed                        | 200 |
| set_search_diamond                     | 200 |
| set_search_limit                       | 201 |
| SGF (Smart Game Format)                | 14  |
| SGF files in memory                    | 159 |
| shape attributes                       | 78  |
| showboard                              | 196 |
| Smart Game Format                      | 14  |
| Speedup of reading process             | 113 |
| start_sgftace                          | 199 |
| string                                 | 47  |
| superstring                            | 170 |
| surround                               | 58  |
| surround_map                           | 200 |
| surround_size                          | 58  |
| surround_status                        | 58  |
| symmetry and transformations           | 95  |
| symmetry and transformations of shapes | 95  |

**T**

|                                            |     |
|--------------------------------------------|-----|
| tactical_analyze_semeai                    | 191 |
| teaching josekis to GNU Go                 | 98  |
| territory                                  | 129 |
| test_eyeshape                              | 196 |
| The Go Modem Protocol and Go Text Protocol | 13  |
| the joseki compiler                        | 98  |
| time_left                                  | 194 |
| time_settings                              | 193 |
| timers                                     | 172 |
| traces                                     | 36  |
| Transposition table                        | 113 |

Trying hypothetical moves ..... 111  
tryko ..... 188  
trymove ..... 188  
tune\_move\_ordering ..... 199  
tuning GNU Go ..... 36  
tuning the pattern database ..... 92  
tuning the shapes database ..... 92

## U

UCT algorithm ..... 146  
unconditional\_status ..... 192  
undo ..... 193  
Usage of the stack in reading ..... 111

## V

version ..... 185

## W

weakness ..... 57  
worm ..... 47  
worm\_cutstone ..... 198  
worm\_data ..... 197  
worm\_stones ..... 198

## Z

Zobrist hashing algorithm ..... 113

# Functions Index

## A

|                                      |             |
|--------------------------------------|-------------|
| abortgo.....                         | 173         |
| accuratelib.....                     | 175         |
| add_eyevalues.....                   | 75          |
| add_false_eye.....                   | 74          |
| add_stone.....                       | 174         |
| adjacent_strings.....                | 177         |
| amalgamate_most_valuable_helper..... | 52          |
| analyze_eyegraph.....                | 75          |
| approxlib.....                       | 175         |
| atari_atari.....                     | 26, 44, 128 |
| atari_atari_blunder_size.....        | 128         |
| atari_atari_confirm_safety.....      | 128         |
| attack.....                          | 112         |

## B

|                   |     |
|-------------------|-----|
| block_off.....    | 138 |
| blunder_size..... | 169 |
| break_in.....     | 138 |

## C

|                                     |         |
|-------------------------------------|---------|
| chainlinks.....                     | 176     |
| chainlinks2.....                    | 176     |
| chainlinks3.....                    | 176     |
| change_dragon_status.....           | 167     |
| clear_board.....                    | 174     |
| color_to_string.....                | 173     |
| combinations.....                   | 128     |
| compute_escape.....                 | 57      |
| compute_eyes.....                   | 74      |
| compute_eyes_pessimistic.....       | 74, 126 |
| compute_influence.....              | 178     |
| compute_surrounding_moyo_sizes..... | 57      |
| confirm_safety.....                 | 169     |
| count_common_libs.....              | 176     |
| countlib.....                       | 175     |
| countstones.....                    | 176     |
| cut_connect_callback.....           | 92      |

## D

|                              |     |
|------------------------------|-----|
| DEBUG.....                   | 173 |
| decrease_depth_values.....   | 169 |
| defend_against.....          | 167 |
| disconnect.....              | 125 |
| does_attack.....             | 167 |
| does_capture_something.....  | 177 |
| does_defend.....             | 167 |
| double_atari.....            | 169 |
| dragon_eye.....              | 52  |
| draw_letter_coordinates..... | 173 |
| dump_stack.....              | 174 |

## E

|                                 |     |
|---------------------------------|-----|
| edge_distance.....              | 174 |
| endgame_shapes.....             | 26  |
| estimate_territorial_value..... | 45  |
| extended_chainlinks.....        | 176 |
| eyevalue_to_string.....         | 75  |

## F

|                                            |        |
|--------------------------------------------|--------|
| far.....                                   | 148    |
| fastlib.....                               | 175    |
| fill_liberty.....                          | 26     |
| find_common_libs.....                      | 176    |
| find_connections.....                      | 92     |
| find_cuts.....                             | 50, 92 |
| find_defense.....                          | 112    |
| find_eye_dragons.....                      | 73     |
| find_half_and_false_eyes.....              | 74     |
| find_neighbor_dragons.....                 | 56     |
| find_origin.....                           | 176    |
| find_proper_superstring_liberties.....     | 171    |
| find_superstring.....                      | 170    |
| find_superstring_liberties.....            | 171    |
| find_superstring_stones_and_liberties..... | 171    |
| findlib.....                               | 175    |
| findstones.....                            | 176    |
| followup.....                              | 80     |
| fuseki.....                                | 25     |

## G

|                                |     |
|--------------------------------|-----|
| gameinfo_clear.....            | 166 |
| gameinfo_load_sgfheader.....   | 166 |
| gameinfo_play_move.....        | 166 |
| gameinfo_play_sgftree.....     | 166 |
| gameinfo_play_sgftree_rot..... | 166 |
| gameinfo_print.....            | 166 |
| get_kom_pos.....               | 174 |
| get_komaster.....              | 174 |
| gfprintf.....                  | 172 |
| gnugo_add_stone.....           | 164 |
| gnugo_attack.....              | 164 |
| gnugo_clear_board.....         | 163 |
| gnugo_estimate_score.....      | 164 |
| gnugo_examine_position.....    | 165 |
| gnugo_find_defense.....        | 164 |
| gnugo_genmove.....             | 164 |
| gnugo_get_board.....           | 165 |
| gnugo_get_boardsize.....       | 165 |
| gnugo_get_komi.....            | 165 |
| gnugo_get_move_number.....     | 165 |
| gnugo_is_legal.....            | 164 |
| gnugo_is_pass.....             | 164 |
| gnugo_is_suicide.....          | 164 |

gnugo\_placehand..... 164  
gnugo\_play\_move..... 164  
gnugo\_play\_sgfnod..... 164  
gnugo\_play\_sgftree..... 164  
gnugo\_recordboard..... 164  
gnugo\_remove\_stone..... 164  
gnugo\_set\_komi..... 163  
gnugo\_sethand..... 164  
gnugo\_undo\_move..... 164  
gnugo\_who\_wins..... 164  
gprintf..... 172

**H**

has\_neighbor..... 177  
hashnode\_new\_result..... 114  
hashtable\_enter\_position..... 114  
hashtable\_search..... 114  
have\_common\_lib..... 176

**I**

increase\_depth\_values..... 169  
influence\_mark\_non\_territory..... 178  
init\_gnugo..... 162, 163  
is\_corner\_vertex..... 174  
is\_edge\_vertex..... 174  
is\_eye\_space..... 74  
is\_false\_eye..... 74  
is\_halfeye..... 74  
is\_hoshi\_point..... 173  
is\_illegal\_ko\_capture..... 174  
is\_ko..... 177  
is\_ko\_point..... 177  
is\_legal..... 29, 174  
is\_marginal\_eye\_space..... 74  
is\_pass..... 174  
is\_proper\_eye\_space..... 74  
is\_self\_atari..... 176  
is\_suicide..... 174

**K**

komaster\_trymove..... 157

**L**

liberty\_of\_string..... 177  
location\_to\_buffer..... 173  
location\_to\_string..... 173

**M**

make\_domains..... 50, 73  
mark\_string..... 177  
max\_eye\_threat..... 75  
max\_eye\_value..... 74

max\_eyes..... 75  
maxterri..... 80  
maxvalue..... 80  
min\_eye\_threat..... 75  
min\_eyes..... 75  
minterri..... 80  
minvalue..... 80  
modify\_depth\_values..... 169  
modify\_eye\_spaces1..... 92  
move\_in\_stack..... 177  
mprintf..... 173

**N**

near..... 148  
neighbor\_of\_string..... 177

**O**

obvious\_false\_eye..... 75  
ocap0..... 148  
ocap1..... 148  
ocap1+..... 148  
ocap1-..... 148  
ocap2..... 148  
ocap2+..... 148  
ocap2-..... 148  
ocap3..... 148  
osafe..... 148  
OTHER\_COLOR..... 162  
ounsaf..... 148  
owl\_attack..... 126  
owl\_defend..... 126  
owl\_reasons..... 25, 43

**P**

partition\_eyespaces..... 73  
play\_attack\_defend\_n..... 168  
play\_attack\_defend2\_n..... 168  
play\_break\_through\_n..... 167  
play\_connect\_n..... 168  
play\_move..... 157  
popgo..... 29, 157  
propagate\_eye..... 73  
proper\_superstring\_chainlinks..... 172  
purge\_persistent\_breakin\_cache..... 116  
purge\_persistent\_connection\_cache..... 116  
purge\_persistent\_owl\_cache..... 116  
purge\_persistent\_reading\_cache..... 116

**R**

remove\_stone..... 174  
restore\_board..... 174  
restore\_depth\_values..... 169  
result\_to\_string..... 173

revise\_semeai ..... 26  
 revise\_thrashing\_dragon ..... 26

## S

safe\_move ..... 113  
 safety\_to\_string ..... 173  
 same\_string ..... 177  
 search\_persistent\_reading\_cache ..... 116  
 second\_order\_liberty\_of\_string ..... 177  
 semeai ..... 25  
 set\_depth\_values ..... 168  
 set\_eyevaluate ..... 75  
 shape ..... 80  
 shapes ..... 25  
 shapes\_callback ..... 77  
 showboard ..... 173  
 simple\_showboard ..... 173  
 small\_semeai ..... 112  
 somewhere ..... 167  
 start\_timer ..... 172  
 status\_to\_string ..... 173  
 stones\_on\_board ..... 177  
 store\_board ..... 174  
 store\_persistent\_reading\_cache ..... 116  
 string\_connect ..... 125  
 string\_to\_location ..... 173  
 superstring\_chainlinks ..... 171

## T

terri ..... 80  
 test\_eyeshape ..... 75  
 test\_symmetry\_after\_move ..... 167  
 time\_report ..... 172

topological\_eye ..... 74  
 tryko ..... 157  
 trymove ..... 29, 156

## U

unconditional\_life ..... 50, 170  
 undo\_move ..... 157

## V

value ..... 80  
 value\_move\_reasons() ..... 44

## W

whose\_area ..... 178  
 whose\_moyo ..... 178  
 whose\_territory ..... 178  
 worm\_reasons ..... 25

## X

xcap0 ..... 148  
 xcap1 ..... 149  
 xcap1+ ..... 149  
 xcap1- ..... 149  
 xcap2 ..... 149  
 xcap2+ ..... 149  
 xcap2- ..... 149  
 xcap3 ..... 149  
 xnosucide ..... 148  
 xsafe ..... 148  
 xsucide ..... 148  
 xunsafe ..... 148