

# The DRM/KMS subsystem from a newbie's point of view





- ▶ Embedded Linux engineer and trainer at Free Electrons
  - ▶ Embedded Linux **development**: kernel and driver development, system integration, boot time and power consumption optimization, consulting, etc.
  - ▶ Embedded Linux **training**, Linux driver development training and Android system development training, with materials freely available under a Creative Commons license.
  - ▶ <http://free-electrons.com>
- ▶ Contributions
  - ▶ **Kernel support for the AT91 SoCs** ARM SoCs from Atmel
  - ▶ **Kernel support for the sunXi SoCs** ARM SoCs from Allwinner
- ▶ Living in **Toulouse**, south west of France



# Agenda

## Context description

What is this talk about ?

How to display things in Linux ?

## DRM/KMS overview

Global architecture

Partial description of the components

## Sharing my experience

Tips on developing a DRM/KMS driver

Integration with userland graphic stacks



## Context: What is this talk about ?

- ▶ Sharing my understanding of the DRM/KMS subsystem learned while working on the Atmel HLCDC driver
- ▶ Explaining some key aspects (from my point of view) of the DRM/KMS subsystem
- ▶ Explaining some common concepts in the video/graphic world and showing how they are implemented in DRM/KMS
- ▶ Sharing some tips on how to develop a KMS driver based on my experience
- ▶ This talk is not:
  - ▶ A detailed description of the DRM/KMS subsystem
  - ▶ A description on how to use a DRM device (user-space API)
  - ▶ And most importantly: this talk is not given by an expert
- ▶ Don't hesitate to correct me if you think I'm wrong ;-)



# Context: How to display things in the Linux world

- ▶ Different solutions, provided by different subsystems:
  - ▶ FBDEV: Framebuffer Device
  - ▶ DRM/KMS: Direct Rendering Manager / Kernel Mode Setting
  - ▶ V4L2: Video For Linux 2
- ▶ How to choose one: it depends on your needs
  - ▶ Each subsystem provides its own set of features
  - ▶ Different levels of complexity
  - ▶ Different levels of activity



## Context: Why choosing DRM/KMS ?

- ▶ Actively maintained
- ▶ Provides fine grained control on the display pipeline
- ▶ Widely used by user-space graphic stacks
- ▶ Provides a full set of advanced features
- ▶ Why not FBDEV ?
  - ▶ Less actively maintained
  - ▶ Does not provides all the features we needed (overlays, hw cursor, ...)
  - ▶ Developers are now encouraged to move to DRM/KMS
- ▶ Why not V4L2 ?
  - ▶ Well suited for video capture and specific video output devices but not for "complex" display controllers



# DRM/KMS: Definition

- ▶ DRM stands for Direct Rendering Manager and was introduced to deal with graphic cards embedding GPUs
- ▶ KMS stands for Kernel Mode Setting and is a sub-part of the DRM API
- ▶ Though rendering and mode setting are now splitted in two different APIs (accessible through `/dev/dri/renderX` and `/dev/dri/controlDX`)
- ▶ KMS provide a way to configure the display pipeline of a graphic card (or an embedded system)
- ▶ KMS is what we're interested in when looking for an FBDEV alternative



# DRM/KMS: Architecture

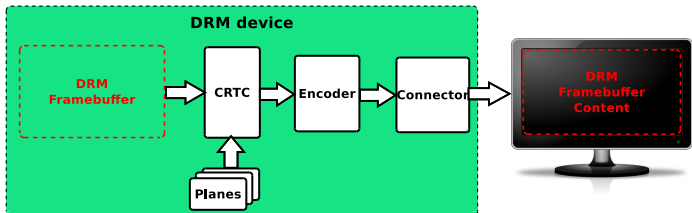
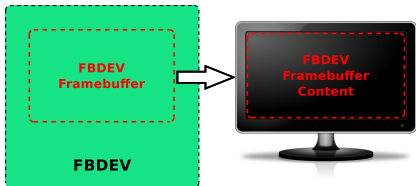





# DRM/KMS Components: Framebuffer

- ▶ This is a standard object storing informations about the content to be displayed
- ▶ Informations stored:
  - ▶ References to memory regions used to store display content
  - ▶ Format of the frame stored in memory
  - ▶ Active area within the memory region (content that will displayed)



# DRM/KMS Components: Framebuffer

- ▶ DRM Framebuffer is a virtual object (relies on a specific implementation)
- ▶ Framebuffer implementation depends on:
  - ▶ The memory manager in use (GEM or TTM)
  - ▶ The display controller capabilities:
    - ▶ Supported DMA transfer types (Contiguous Memory or Scatter Gather)
    - ▶ IOMMU
- ▶ Default implementation available for GEM objects using CMA (Contiguous Memory Allocator):  
`drivers/gpu/drm/drm_fb_cma_helper.c`
- ▶ Other implementations usually depend on the Display Controller
  - ▶ Scatter Gather example: `drivers/gpu/drm/tegra/`
  - ▶ IOMMU example: `drivers/gpu/drm/exynos/`



# DRM/KMS Components: Framebuffer

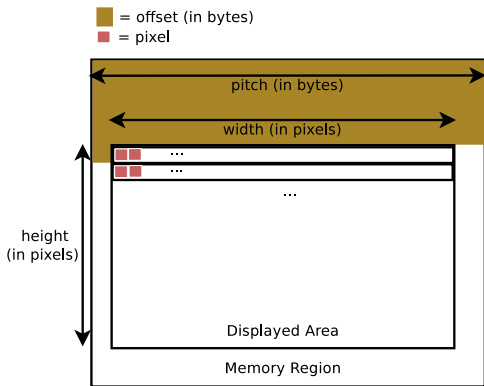

```
struct drm_framebuffer {  
    [...]  
    unsigned int pitches[4];  
    unsigned int offsets[4];  
    unsigned int width;  
    unsigned int height;  
    [...]  
};
```



# DRM/KMS Components: Framebuffer

```
struct drm_framebuffer {  
    [...]  
    uint32_t pixel_format; /* fourcc format */  
    [...]  
};
```

- ▶ `pixel_format` describes the memory buffer organization
- ▶ Uses FOURCC format codes
- ▶ Supported formats are defined here:  
`include/drm/drm_fourcc.h`
- ▶ These FOURCC formats are not standardized and are thus only valid within the DRM/KMS subsystem



# DRM/KMS Components: Framebuffer

- ▶ Three types of formats used by the DRM/KMS subsystem:
  - ▶ RGB: Each pixel is encoded with an RGB tuple (a specific value for each component)
  - ▶ YUV: Same thing but with Y, U and V components
  - ▶ C8: Uses a conversion table to map a value to an RGB tuple
- ▶ YUV support different modes:
  - ▶ Packed: One memory region storing all components (Y, U and V)
  - ▶ Semiplanar: One memory region for Y component and one for UV components
  - ▶ Planar: One memory region for each component
- ▶ Each memory region storing a frame component (Y, U or V) is called a *plane*



# DRM/KMS Components: Framebuffer

- ▶ Packed formats: only the first offsets and pitches entries are used
- ▶ Semiplanar formats: the first two entries are used
- ▶ Planar: the first 3 entries are used
- ▶ Don't know what is the fourth entry used for (alpha plane ?)

```
struct drm_framebuffer {  
    [...]  
    unsigned int pitches[4];  
    unsigned int offsets[4];  
    [...]  
};
```



# DRM/KMS Components: CRTC

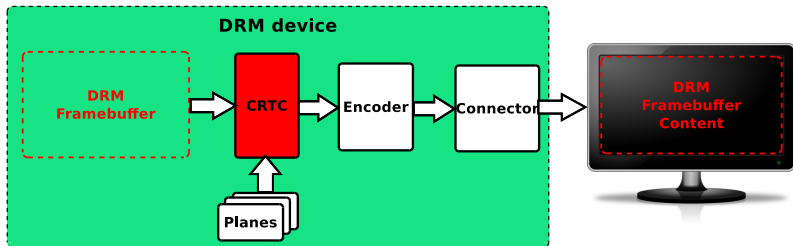



# DRM/KMS Components: CRTC

- ▶ CRTC stands for CRT Controller, though it's not only related to CRT displays
- ▶ Configure the appropriate display settings:
  - ▶ Display timings
  - ▶ Display resolution
- ▶ Scan out frame buffer content to one or more displays
- ▶ Update the frame buffer
- ▶ Implemented through `struct drm_crtc_funcs` and `struct drm_crtc_helper_funcs`

```
struct drm_crtc_funcs {  
[...]  
int (*set_config)(struct drm_mode_set *set);  
int (*page_flip)(struct drm_crtc *crtc,  
                struct drm_framebuffer *fb,  
                struct drm_pending_vblank_event *event, uint32_t flags);  
[...]  
};
```





# DRM/KMS Components: CRTC (mode setting)

- ▶ `set_config` is responsible for configuring several things:
  - ▶ Update the frame buffer being scanned out
  - ▶ Configure the display mode: timings, resolution, ...
  - ▶ Attach connectors/encoders to the CRTC
- ▶ Use `drm_crtc_helper_set_config` function and implement `struct drm_crtc_helper_funcs` unless you really know what you're doing

```
struct drm_crtc_helper_funcs {  
[...]  
    int (*mode_set)(struct drm_crtc *crtc,  
                    struct drm_display_mode *mode,  
                    struct drm_display_mode *adjusted_mode,  
                    int x, int y,  
                    struct drm_framebuffer *old_fb);  
[...]  
};
```



# DRM/KMS Components: CRTC (display timings)

- ▶ How display content is updated hasn't changed much since the creation of CRT monitors (though technology has evolved)
- ▶ Requires at least 3 signals:
  - ▶ Pixel Clock: drive the pixel stream (1 pixel updated per clock cycle)
  - ▶ VSYNC: Vertical Synchronisation signal, asserted at the beginning of each frame
  - ▶ HSYNC: Horizontal Synchronisation signal, asserted at the beginning of each pixel line



# DRM/KMS Components: CRTC (display timings)

- ▶ HSYNC pulse is used to inform the display it should go to the next pixel line
- ▶ VSYNC pulse is used to inform the display it should start to display a new frame and thus go back to the first line
- ▶ What's done during the VSYNC and HSYNC pulses depends on the display technology
- ▶ Front and back porch timings are reserved time around the sync pulses. Action taken during those periods also depends on the display technology



# DRM/KMS Components: CRTC (display timings)

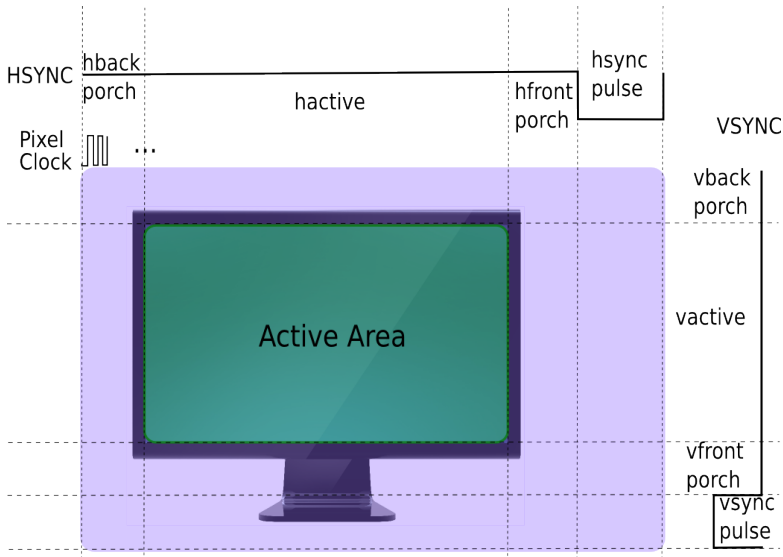



# DRM/KMS Components: CRTC (display timings)

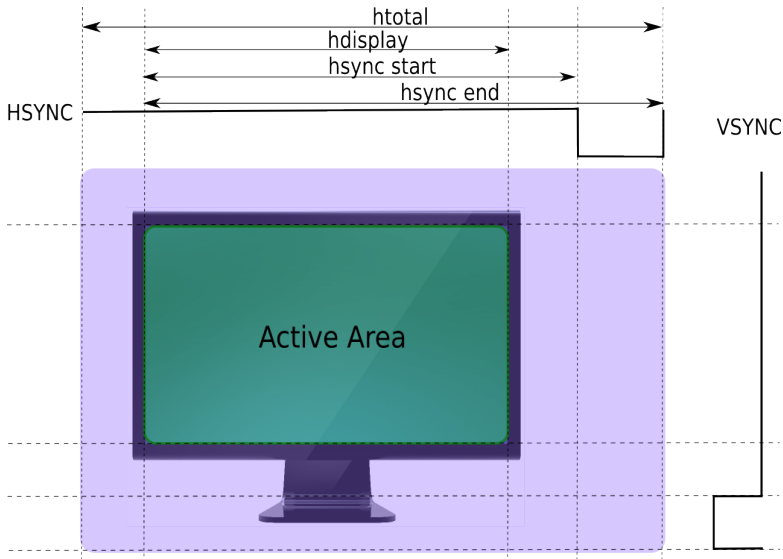



# DRM/KMS Components: CRTC (mode setting)

Framebuffer





# DRM/KMS Components: CRTC (mode setting)

```
static int atmel_hlcdc_crtc_mode_set(struct drm_crtc *c,
    struct drm_display_mode *mode,
    struct drm_display_mode *adj,
    int x, int y,
    struct drm_framebuffer *old_fb)
{
    /* Initialize local variables */
    struct atmel_hlcdc_crtc *crtc = drm_crtc_to_atmel_hlcdc_crtc(c);
    [...]

    /* Do some checks on the requested mode */
    if (atmel_hlcdc_dc_mode_valid(crtc->dc, adj) != MODE_OK)
        return -EINVAL;

    /* Convert DRM display timings into controller specific ones */
    vm.vfront_porch = adj->crtc_vsync_start - adj->crtc_vdisplay;
    [...]

    /* Configure controller timings */
    regmap_write(regmap, ATMEL_HLCD_CCFG(1), (vm.hsync_len - 1) | ((vm.vsync_len - 1) << 16));
    [...]

    /* Update primary plane attached to the CRTC */
    fb = plane->fb;
    plane->fb = old_fb;

    return plane->funcs->update_plane(plane, c, fb, 0, 0, adj->hdisplay, adj->vdisplay,
        x << 16, y << 16, adj->hdisplay << 16,
        adj->vdisplay << 16);
}
```



# DRM/KMS Components: CRTC (page flipping)

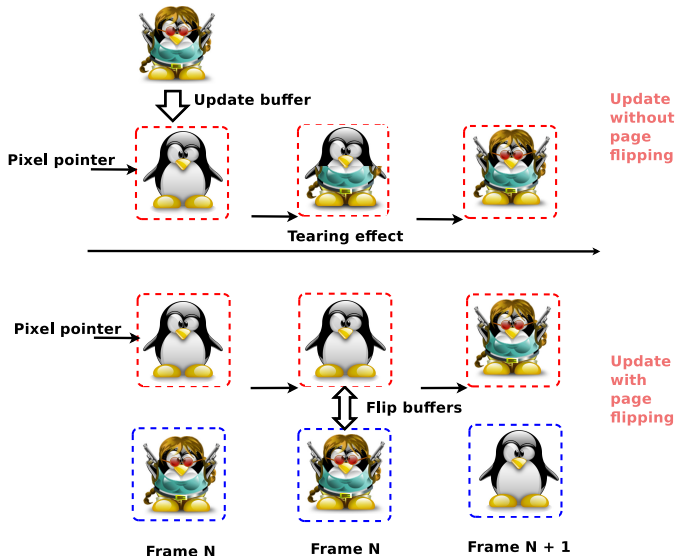





# DRM/KMS Components: CRTC (page flipping)

- ▶ `page_flip` is responsible for queuing a frame update

```
struct drm_crtc_funcs {  
[...]  
    int (*page_flip)(struct drm_crtc *crtc,  
                    struct drm_framebuffer *fb,  
                    struct drm_pending_vblank_event *event,  
                    uint32_t flags);  
[...]  
};
```

- ▶ The frame is really updated at the next VBLANK (interval between 2 frames)
- ▶ Only one page flip at a time
- ▶ Should return `EBUSY` if a page flip is already queued
- ▶ `event` is used to inform the user when page flip is done (the 2 frames are actually flipped)



# DRM/KMS Components: CRTC (page flipping)

```
static int atmel_hlcdc_crtc_page_flip(struct drm_crtc *c, struct drm_framebuffer *fb,
                                     struct drm_pending_vblank_event *event,
                                     uint32_t page_flip_flags)
{
    /* Initialize local variables */
    struct atmel_hlcdc_crtc *crtc = drm_crtc_to_atmel_hlcdc_crtc(c);
    [...]

    /* Check if there's a pending page flip request */
    spin_lock_irqsave(&dev->event_lock, flags);
    if (crtc->event)
        ret = -EBUSY;
    spin_unlock_irqrestore(&dev->event_lock, flags);
    if (ret)
        return ret;
    [...]

    /* Store the event to inform the caller when the page flip is finished */
    if (event) {
        drm_vblank_get(c->dev, crtc->id);
        spin_lock_irqsave(&dev->event_lock, flags);
        crtc->event = event;
        spin_unlock_irqrestore(&dev->event_lock, flags);
    }

    /* Queue a primary plane update request */
    ret = atmel_hlcdc_plane_apply_update_req(plane, &req);
    [...]

    return ret;
}
```



# DRM/KMS Components: Planes

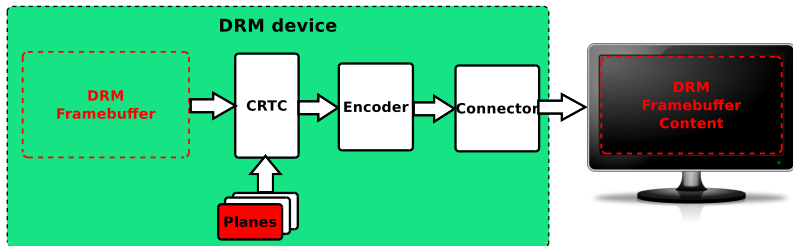



# DRM/KMS Components: Planes

- ▶ A plane is an image layer (**Be careful**: not related to the planes referenced by a framebuffer)
- ▶ The final image displayed by the CRTC is the composition of one or several planes
- ▶ Different plane types:
  - ▶ `DRM_PLANE_TYPE_PRIMARY` (mandatory, 1 per CRTC)
    - ▶ Used by the CRTC to store its frame buffer
    - ▶ Typically used to display a background image or graphics content
  - ▶ `DRM_PLANE_TYPE_CURSOR` (optional, 1 per CRTC)
    - ▶ Used to display a cursor (like a mouse cursor)
  - ▶ `DRM_PLANE_TYPE_OVERLAY` (optional, 0 to N per CRTC)
    - ▶ Used to benefit from hardware composition
    - ▶ Typically used to display windows with dynamic content (like a video)
    - ▶ In case of multiple CRTCs in the display controller, the overlay planes can often be dynamically attached to a specific CRTC when required



# DRM/KMS Components: Planes

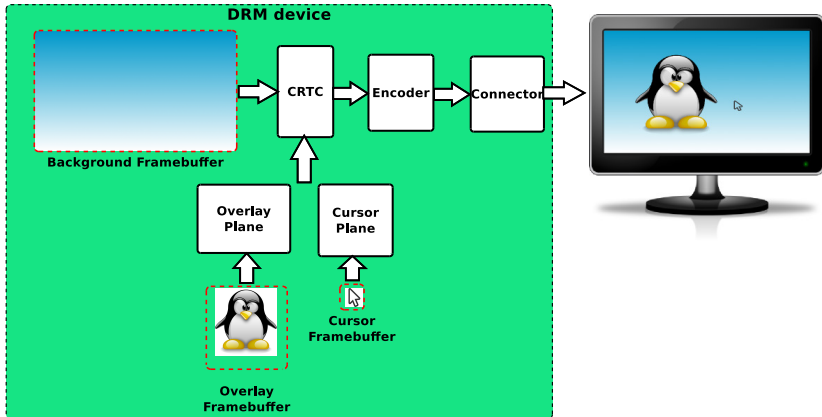



# DRM/KMS Components: Planes

- ▶ Plane support implemented through `struct drm_plane_funcs`

```
struct drm_plane_funcs {  
[...]  
    int (*update_plane)(struct drm_plane *plane,  
                        struct drm_crtc *crtc,  
                        struct drm_framebuffer *fb,  
                        int crtc_x, int crtc_y,  
                        unsigned int crtc_w, unsigned int crtc_h,  
                        uint32_t src_x, uint32_t src_y,  
                        uint32_t src_w, uint32_t src_h);  
[...]  
};
```



# DRM/KMS Components: Planes (update)

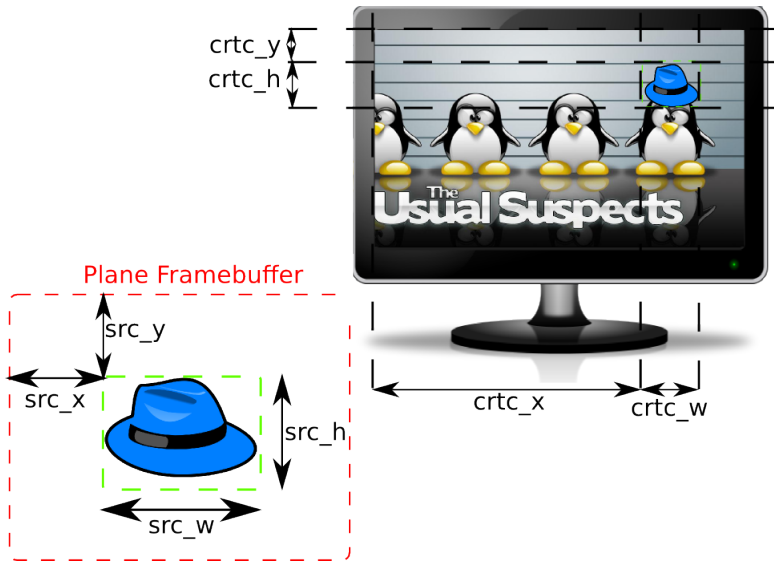



# DRM/KMS Components: Planes (update)

```
static int atmel_hlcdc_plane_update(struct drm_plane *p,
                                   struct drm_crtc *crtc,
                                   struct drm_framebuffer *fb,
                                   int crtc_x, int crtc_y,
                                   unsigned int crtc_w, unsigned int crtc_h,
                                   uint32_t src_x, uint32_t src_y,
                                   uint32_t src_w, uint32_t src_h)
{
    struct atmel_hlcdc_plane *plane = drm_plane_to_atmel_hlcdc_plane(p);
    struct atmel_hlcdc_plane_update_req req;
    int ret = 0;

    /* Fill update request with informations passed in arguments */
    memset(&req, 0, sizeof(req));
    req.crtc_x = crtc_x;
    req.crtc_y = crtc_y;
    [...]

    /* Prepare a plane update request: reserve resources, check request
       coherency, ... */
    ret = atmel_hlcdc_plane_prepare_update_req(&plane->base, &req);
    if (ret)
        return ret;
    [...]

    /* Queue the plane update request: update DMA transfers at the next
       VBLANK event */
    return atmel_hlcdc_plane_apply_update_req(&plane->base, &req);
}
```





# DRM/KMS Components: Connector

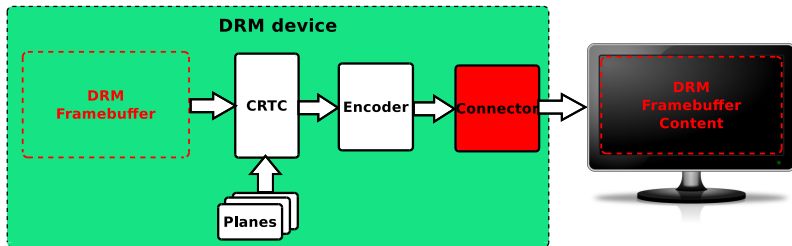



# DRM/KMS Components: Connector

- ▶ Represent a display connector (HDMI, DP, VGA, DVI, ...)
- ▶ Transmit the signals to the display
- ▶ Detect display connection/removal
- ▶ Expose display supported modes



# DRM/KMS Components: Connector

- ▶ Implemented through `struct drm_connector_funcs` and `struct drm_connector_helper_funcs`

```
struct drm_connector_helper_funcs {
    int (*get_modes)(struct drm_connector *connector);
    enum drm_mode_status
        (*mode_valid)(struct drm_connector *connector,
                      struct drm_display_mode *mode);
    struct drm_encoder *
        (*best_encoder)(struct drm_connector *connector);
};
```

```
struct drm_connector_funcs {
    [...]
    enum drm_connector_status
        (*detect)(struct drm_connector *connector, bool force);
    [...]
};
```



# DRM/KMS Components: Connector (get modes)

```
static int rcar_du_lvds_connector_get_modes(struct drm_connector *connector)
{
    struct rcar_du_lvds_connector *lvdscon = to_rcar_lvds_connector(connector);
    struct drm_display_mode *mode;

    /* Create a drm_display_mode */
    mode = drm_mode_create(connector->dev);
    if (mode == NULL)
        return 0;

    /* Fill the mode with the appropriate timings and flags */
    mode->type = DRM_MODE_TYPE_PREFERRED | DRM_MODE_TYPE_DRIVER;
    mode->clock = lvdscon->panel->mode.clock;
    mode->hdisplay = lvdscon->panel->mode.hdisplay;
    [...]

    /* Give this mode a name based on the resolution: e.g. 800x600 */
    drm_mode_set_name(mode);

    /* Add this mode to the connector list */
    drm_mode_probed_add(connector, mode);

    /* Return the number of added modes */
    return 1;
}
```



# DRM/KMS Components: Encoder

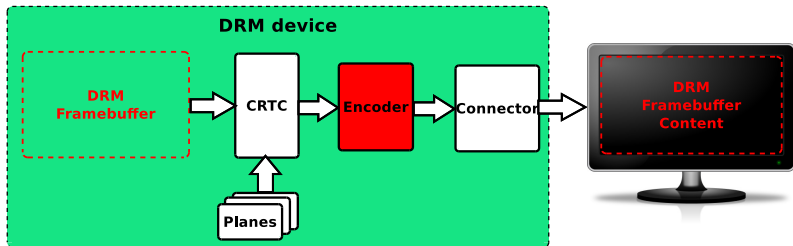



# DRM/KMS Components: Encoder

- ▶ Directly related to the Connector concept
- ▶ Responsible for converting a frame into the appropriate format to be transmitted through the connector
- ▶ Example: HDMI connector is transmitting TMDS encoded data, and thus need a TMDS encoder.



# DRM/KMS Components: Encoder

- ▶ Implemented through `struct drm_encoder_funcs` and `struct drm_encoder_helper_funcs`

```
struct drm_encoder_helper_funcs {  
[...]  
    bool (*mode_fixup)(struct drm_encoder *encoder,  
                       const struct drm_display_mode *mode,  
                       struct drm_display_mode *adjusted_mode);  
[...]  
    void (*mode_set)(struct drm_encoder *encoder,  
                    struct drm_display_mode *mode,  
                    struct drm_display_mode *adjusted_mode);  
[...]  
};
```



# DRM/KMS Components: DRM device

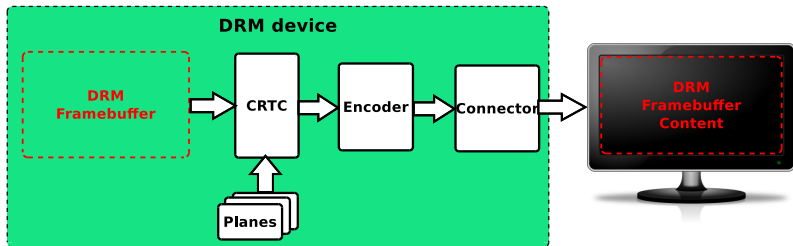





# DRM/KMS Components: DRM device

- ▶ Responsible for aggregating the other components
- ▶ Device exposed to the userspace (handles all user-space requests)
- ▶ Implemented through `struct drm_driver`

```
struct drm_driver {  
    int (*load) (struct drm_device *, unsigned long flags);  
    [...]  
    int (*unload) (struct drm_device *);  
    [...]  
    u32 driver_features;  
    [...]  
};
```



## DRM/KMS Components: DRM device

- ▶ Call `drm_dev_alloc` then `drm_dev_register` to register a DRM device
- ▶ `load` and `unload` are responsible for instantiating and destroying the DRM components attached to a DRM device
- ▶ `driver_features` should contain `DRM_RENDER`, `DRM_MODE_SET` or both depending on the DRM device features



# DRM/KMS Components: DRM device

```
static struct drm_driver atmel_hlcdc_dc_driver = {
    .driver_features = DRIVER_HAVE_IRQ | DRIVER_GEM | DRIVER_MODESET,
    .load = atmel_hlcdc_dc_load,
    .unload = atmel_hlcdc_dc_unload,
    [...]
    .name = "atmel-hlcdc",
    .desc = "Atmel HLCD Controller DRM",
    .date = "20141504",
    .major = 1,
    .minor = 0,
};
```



# DRM/KMS Components: DRM device

```
static int atmel_hlcdc_dc_drm_probe(struct platform_device *pdev)
{
    struct drm_device *ddev;
    int ret;

    ddev = drm_dev_alloc(&atmel_hlcdc_dc_driver, &pdev->dev);
    if (!ddev)
        return -ENOMEM;

    ret = drm_dev_set_unique(ddev, dev_name(ddev->dev));
    if (ret) {
        drm_dev_unref(ddev);
        return ret;
    }

    ret = drm_dev_register(ddev, 0);
    if (ret) {
        drm_dev_unref(ddev);
        return ret;
    }

    return 0;
}
```



# DRM/KMS Components: Other concepts

- ▶ DPMS: Display Power Management Signaling
- ▶ Properties: transversal concept used to expose display pipeline behaviors
  - ▶ Can be attached to all the component we've seen so far
  - ▶ Examples:
    - ▶ Rotation is a plane property
    - ▶ EDID (Unique display ID exposed by a monitor) is a connector property
    - ▶ ...
- ▶ Bridge: represent an external encoder accessible through a bus (spi, i2c)
- ▶ Encoder slave: pretty much the same thing (still don't get the difference)
- ▶ FBDEV emulation
- ▶ Multiple CRTCs, Encoders and Connectors
- ▶ Other concepts I'm not aware of yet :-)



# DRM/KMS Sequence Diagram: Mode Setting

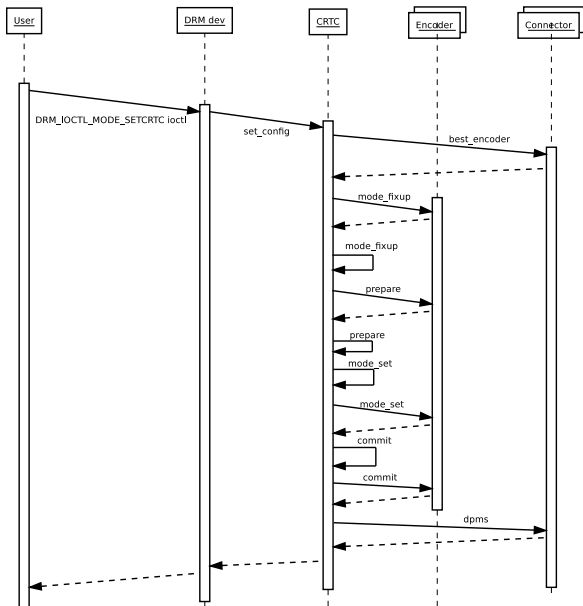



# KMS Driver: Development Tips

- ▶ Read the documentation:  
<https://www.kernel.org/doc/html/docs/drm/>
- ▶ Take a look at other drivers
  - ▶ Choose a similar driver (in terms of capabilities)
  - ▶ Check that the driver you are basing your work on is recent and well maintained
- ▶ Check for new features: the DRM subsystem is constantly evolving
- ▶ Use helper functions and structures as much as possible
- ▶ Start small/simple and add new features iteratively (e.g. only one primary plane and one encoder/connector pair)
- ▶ Use simple user-space tools to test it like `modetest`



# KMS Userland Graphic Stacks

- ▶ Tried weston (standard wayland implementation) and Qt with a KMS backend
- ▶ First thing to note: they're not ready for KMS drivers without OpenGL support (`DRM_RENDER` capabilities!)
  - ▶ Wayland works (thanks to pixman support) but does not support planes and hardware cursors when OpenGL support is disabled
  - ▶ Qt only works with the fbdev backend
  - ▶ WIP on the mesa stack to provide soft OpenGL when using a KMS driver without OpenGL support
  - ▶ But the window composition will most likely be done through the soft OpenGL, which implies poor performances
- ▶ Not sure you can choose a specific plane when using a window manager (e.g. stream video content on a plane which support YUV format)



# Questions?

Boris Brezillon

`boris.brezillon@free-electrons.com`

Slides under CC-BY-SA 3.0

<http://free-electrons.com/pub/conferences/2014/elce/brezillon-drm-kms/>